

VARO Shelving and Stocking System, Workshop Lorries, Assortments, Vehicle Modules

	VARO Shelving and Stocking System Page 2		VAROBOXX, Accessories Page 146
	Safety Cases and Assortments Page 13		VAROBOXX Assortments Page 152
	Perforated Panels and Hook Systems Page 72		VAROiBOXX, VAROiBOXX RACK, Accessories Page 155
	Storage Racks and Boxes Page 76		VAROBOXX Mini, Accessories, VAROBOXX Mini Assortments Page 164
	Tool Trolleys, VAROsoft System Inserts Page 93		VAROMOBIL Equipment Modules Page 285
	Workbenches, Windscreen Supports, Vices Page 131		VAROMOBIL Accessories Page 330
	Barrel Racking, Collecting Trays Page 137		VAROMOVE Module, Accessories Page 341
	Roller Stools, Boards Page 141		Roof Racks, Accessories Page 357

VARO Shelving and Stocking System

- FÖRCH VARO shelving and storage system consists of special units which can be combined into a tower
- The result is your personal VARO system
- VARO is space saving
- Sizes of one tower HxWxD: 2.160 x 784 x 400 mm
- Each VARO tower can be positioned separately = in terms of workplace

The benefits that VARO brings you

Optimum use of space

- Customised, space-saving structure in your workshop
- Modules are matched to our packaging
- Can be easily extended

Clearly arranged stocking

- Individual modules for the respective product groups
- Standardised labelling of the bin locations

Low rent

- No finance costs

For you, this means

- Shorter paths, less expenditure of time, greater effectiveness and minimisation of your process costs

VARO Base / Perforated Panel Unit

- Dimensions base (H x W x D): 240 x 784 x 400 mm
- Dimensions perforated panel (H x W x D): 480 x 784 x 400 mm
- Load capacity per shelf board: 35 kg surface weight
- Max. load per shelf area: 300 kg

Article No.	Article Description	QTY
9100 0	VARO 0/9 BASE/PERFORATED PANEL	1

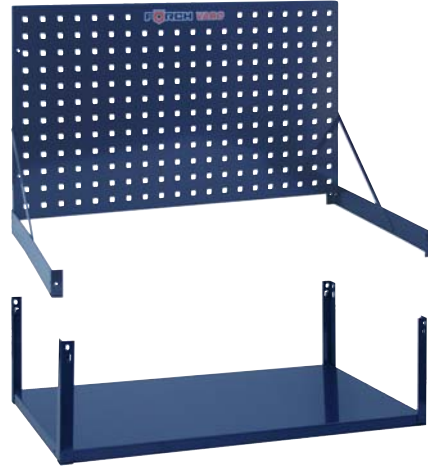

VARO Closure and Base Unit

- Dimensions (H x W x D): 240 x 784 x 400 mm
- Load capacity per shelf board: 35 kg surface weight
- Max. load per shelf area: 300 kg

Article No.	Article Description	QTY
9100 07	VARO 0/7 BASE/CLOSURE UNIT	1



VARO Box Units

- Dimensions (H x W x D): 480 x 784 x 400 mm
- Load capacity per shelf board: 35 kg surface weight
- Max. load per shelf area: 300 kg

Art. No. 9100 2:

- 3 shelves divided for 21 / 42 boxes size 2 Art. No. 9056 1 or 21 shelf boxes blue Art. No. 9054 400 93 or 21 tool boxes

Art. No. 9100 3:

- 3 shelves for 15 transparent boxes size 3 Art. No. 9057 1 or 12 shelf boxes blue Art. No. 9054 400 186

Article No.	Article Description	QTY
9100 2	VARO 3 TRAYS SIZE 3	1
9056 1	VARO STORAGE BOX BLUE SIZE 2	e 72
9054 400 93	SHELF-BOX RK 400/93 BLUE	e 16
9054 93	DIVIDING WALL RK/T 93	e 25
9100 3	VARO 3 TRAYS SIZE 3	1
9057 1	VARO STORAGE BOX GR.3 BLUE	e 30
9054 400 186	SHELF-BOX RK 400/186 BLUE	e 8
9054 186	DIVIDING WALL RK/T 186	e 25



VARO Flap Carton Unit

- Dimensions (H x W x D): 480 x 784 x 400 mm
- Load capacity per shelf board: 35 kg surface weight
- Max. load per shelf area: 300 kg
- Fall of chute 10°
- Height 70 mm
- 10 dividers create 12 compartments
- Two-fold

Article No.	Article Description	QTY
9100 23	VARO 23 FLAP CARTON UNIT 2FOLD	1



VARO Chem. Elements with Variable Stirrup Brackets

- Dimensions (H x W x D): 480 x 784 x 400 mm
- Load capacity per shelf: 35 kg surface distributed
- Max. load per shelf box: 300 kg
- For all aerosol cans and various kinds of packages such as litre cans, cartridges, etc.
- The chemical element can be individually assembled using the removable stirrup

Art. No. 9100 55:

- 1x with 10 metal brackets

Art. No. 9100 44:

- 2x with 20 metal brackets
- Shelf distance: 215 mm

Article No.	Article Description	QTY
9100 55	VARO 55 CHEMICAL 1-SHELF	1
9100 44	VARO 44 CHEMICAL 2-SHELVES	1



VARO Universal / Carton Unit

- Dimensions (H x W x D): 480 x 784 x 400 mm
- Load capacity per shelf: 35 kg surface distributed
- Max. load per shelf box: 300 kg

Art. No. 9100 7:

- 1 shelf

Art. No. 9100 77:

- 2 shelves

Art. No. 9100 6:

- Shelf is tilted forward to make access to parts easier

Article No.	Article Description	QTY
9100 7	VARO 7 UNIVERSAL BASE	1
9100 77	VARO 77 UNIVERSAL BASE 2LEVELS	1
9100 6	VARO 6 CARTON CHEMISTRY	1



VARO Lamp Cabinet

- Dimensions (H x W x D): 480 x 784 x 400 mm
- Load capacity per shelf: 35 kg surface distributed
- Max. load per shelf box: 300 kg
- Lockable
- 2 height adjustable shelves

Article No.	Article Description	QTY
9100 22	VARO LAMP CABINET	1
9100 22 1	LOCK,VARO LAMP CABINET	1

Scope of delivery:

- Art. No. 3805 10: lamp tester
- Art. No. 3880N 9: E block



VARO Drawer Unit

- Dimensions (H×W×D): 480×784×400 mm
- Load capacity per shelf: max. 14 kg
- Max. load per shelf box: max. 50 kg
- Sorted and clear storage of valuable parts and all DIN and standard parts in the assortments
- 3 FÖRCH assortments fit in each drawer

Art. No. 9100 1:

- Drawer element has 3 individual drawers

Art. No. 9100 8:

- Drawer element has 5 individual drawers
- Lockable



Article No.	Article Description	QTY
9100 1	VARO 1 3-DRAWER	1
9100 8	VARO 8 5-DRAWER	1
9100 8 1	LOCK - DIFFERENT FOR 9100 8	1
9100 8 2	MASTER KEY FOR 9100 8 1	1

VARO Retrofit Divider Set for Drawer Unit

- Individual assembly of drawer
- 6 drawer tray mounts pre-glued with double sided tape

Technical Data	
Item elements:	Dimensions (L×S×H):
2 drawer tray mounts long	333 × 1.10 × 50 mm
4 compartment mounts short	233 × 3.30 × 50 mm
2 dividers	235 × 1.60 × 50 mm
3 longitudinal dividers	223 × 0.95 × 50 mm

Article No.	Article Description	QTY
9100 8 3	DIVIDER SET DRAWER 11-PCE	1

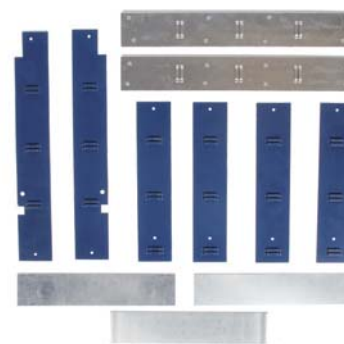

VARO Rubber Insert for Drawers

- No scratching of the drawer bottom
- No slipping of the contents in the drawer
- Noise-reducing when inserting small metal parts
- Rubber inlay 700 × 332 mm

Article No.	Article Description	QTY
9100 8 4	RUBBER INSERT DRAWER 700X332	e 5



VARO Unit for Threaded Rods

- Dimensions (H×W×D): 784×480×400 mm
- For threaded rods, rails and profiles

Article No.	Article Description	QTY
9100 24	VARO 24 THREADED ROD - RACK	1



VARO Screen Door Pair Retrofit Kit

- Lockable screen door pair
- Easy mounting on any VARO shelf unit possible
- Dimensions (H x W x D): 1,900 x 780 x 45 mm

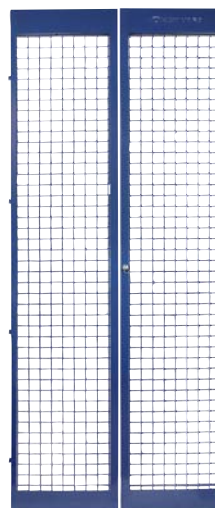

Article No.	Article Description	QTY
9100 27	VARO 27 LATTICE DOOR	1
9100 27 001	MASTERKEY VARO LATTICE DOOR	1
9100 27 002	E-LOCK VAR.KEY.V.LATTICE DOOR	1
9100 27 003	E-LOCK SIMULTANEOUS LO.LAT.D.	1

VARO Perforated Rear Side Panel

- Additional storage space for hooks, roll holder and various work materials
- Easy mounting on any VARO shelf unit possible

Art. No. 9100 98:

- Dimensions (H x W x D): 1,920 x 395 x 1.5 mm
- Suitable for base / perforated panel unit Art. No. 9100 0

Art. No. 9100 99:

- Dimensions (H x W x D): 1,920 x 395 x 1.5 mm
- Suitable for base / perforated panel unit Art. No. 9100 07

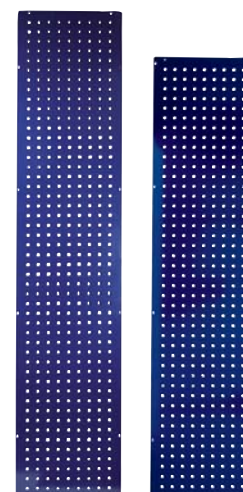

9100 99

9100 98

Article No.	Article Description	QTY
9100 99	VARO 99 PERF.REAR SIDE PANEL	1
9100 98	VARO 98 PERF.RE.SIDE PAN.SHORT	1

VARO Corner Rack with Perforated Panel

- Contact width: 500 mm
- In total 4 shelf boards
- Load capacity per shelf board: 35 kg surface weight
- Max. load per shelf area: 300 kg

Art. No. 9100 25:

- Dimensions (H x W x D): 2,160 x 784 x 784 mm

Art. No. 9100 25 1:

- Dimensions (H x W x D): 1,920 x 784 x 784 mm



9100 25



9100 25 1

VARO Cabinet with Perforated Panel

- 2 doors, cylinder lock
- 4 shelf boards, 3 of them with height adjustment
- Capacity per shelf board: 50 kg
- Dimensions (H x W x D): 2,160 x 784 x 400 mm

Article No.	Article Description	QTY
9100 21	VARO 21 CABINET WITH PERF.PAN.	1
9100 21 9	LOCK FOR VARO CABIN.21 TO 9/07	1
9100 21 10	LOCK FOR VARO CAB.21 FROM10/07	1
9100 21 2	SHELF BASE W.SUPPORT 776X360MM	1 v
9100 21 2 1	SUPPORT FOR SHELF BASE "M"	1
9100 21 2 2	SUPPORT FOR SHELF BASE "D"	1



VARO Windscreen Wiper Display Rack

- Dimensions (H x W x D): 2,165 x 783 x 400 mm
- Clear and space-saving arrangement
- Customer-orientated, encourages sales
- Simple inventory control
- The utmost stability through a wall-mount, or with 2 windscreen wiper display racks screwed back-to-back
- Up to 20 hooks for a perforated wall available for different types of wiper

Article No.	Article Description	QTY
9100 41	VARIO CABINET	1

Scope of delivery:

- Wall attachment set, assembly instructions

Compatible accessories:

- Art. No. 9101 1200: slat wall hooks

Wiper blade usage list:

- Art. No. 9890 25: SWF car/commercial vehicle
- Art. No. 9890 3058 3059: ECO Flat wiper blades vehicle
- Art. No. 9890 3059: ECO Metal wiper bl.vehicle
- Art. No. 9890 3059 9: ECO Metal wiper bl. comm.vehicle



VARO Workshop Mobile Toolbench

- Flexible, mobile VARO module for trades and industrial requirements
- Colour: RAL 5003 blue
- Dimensions:**
- VARO mobile trolley overall (H×W×D): 1.341 × 784 × 401 mm
- Clear height of empty bottom compartment: 229 mm
- Wooden worktop: 50 mm



Article No.	Article Description	QTY
9100 8 10	VARO WORKSHOP MOBILE TOOLBENCH	1

Your Advantage / Benefit

- Allows flexible workplace design
- With built-in 5-drawer unit for organised storage of sorted small parts
- Can be integrated into FÖRCH VARO shelf and storage system
- Perforated tool-holder panel, also for consumables
- Stable worktop for various assembly and dismantling jobs
- Bottom module for heavy spare parts, tools and case sets
- Mounting vice possible

Application

- Ideal as flexible workplace for electricians
- Flexible and stationary workspace for automotive, construction trades and industry
- Storage space



Related Products

- **VARO** Retrofit divider set for drawer unit

Art. No. 9100 8 3



- **VARO** Rubber insert for drawers

Art. No. 9100 8 4



- Vices

Art. No. 4718 120



Electronic Lettering Instrument

- To create high-value, self-adhesive labels
- Printing preview visible in the LCD-display with 13 characters
- 2 different font sizes
- Shortcut key for punctuation mark and currency symbols
- Memory function for last printed label
- Required batteries: 6 pieces of Mignon (AA), not included in delivery
- 19 different languages can be set: GER, EST, ENG, SPA, FRE, ITA, LAV, LIT, HUN, DUT, NOR, POL, POR, SLV, FIN, SWE, TUR, CZE, DAN



Article No.	Article Description	QTY
9851 5000	LABEL PRINTER DYMO-POCKET	1
9851 5001	LABEL CASS.12MMX7M F.DYMO-POC.	e 5

Scope of delivery:

- Labelling device with scroll tape 12 mm x 3 m

Cable Dispenser System

- For clear, space-saving storage
- Individually removable cable spools
- Cable spool stopper in addition for the holder
- One or more spool holder can be mounted on all FÖRCH perforated panels or rack systems

Art. No. 3799 1:

- Dimensions (H x W x D): 145 x 95 x 140 mm

Art. No. 3799 4:

- for 4 cable spool holder
- Dimensions (H x W x D): 133 x 465 x 15 mm

Art. No. 3799 370:

- Dimensions (H x W x D): 110 x 105 x 135 mm

Art. No. 3799 10:

- Tape dispenser

Article No.	Article Description	QTY
3799 1	CABLE SPOOL HOLDER	1
3799 4	PERFORATED PANEL FOR DISPENSER	1
3799 370	CABLE SPOOL STOPPER	1
3799 10	ADH.TAPED DISP.SYST.AXIS	1

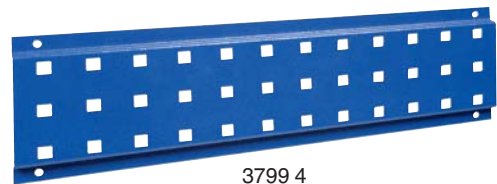

3799 4



3799 1



3799 370



3799 10

Cable Dispenser – Assembled

Contents Art. No. 3729 4:

Article No.	Article Description	Quantity
3720 075	RO(100M) CABLE FLY 0.75 BLACK	1
3720 15	RO(100M) CABLE FLY 1.5 BLACK	1
3720 15 2	RO(100M) CABLE FLY 1.5 RED	1
3721 2 075	RO(50M) SPEAKER CABLE 2X0,75	1
3799 1	CABLE SPOOL HOLDER	4
3799 4	PERFORATED PANEL FOR DISPENSER	1



3729 4

Contents Art. No. 3729 8:

Article No.	Article Description	Quantity
3720 075	RO(100M) CABLE FLY 0.75 BLACK	1
3720 075 2	RO(100M) CABLE FLY 0.75 RED	1
3720 15	RO(100M) CABLE FLY 1.5 BLACK	1
3720 15 2	RO(100M) CABLE FLY 1.5 RED	1
3720 15 8	RO(100M) CABLE FLY 1.5 BROWN	1
3720 25	RO(50M) CABLE 2,5 BLACK	1
3721 2 075	RO(50M) SPEAKER CABLE 2X0,75	1
3722 2 15	RO(25M) CABLE FLY BN/BK2X1.5FL	1
3729 8 1	CABLE DISP.F.8 ROL.NOT ASSEMB.	1

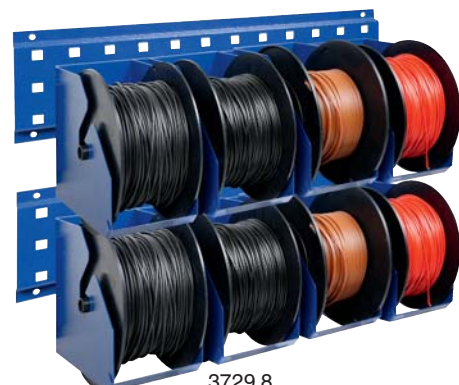

3729 8

Article No.	Article Description	QTY
3729 4	CABLE DISP.ASSEMBLED WITH 4RO.	1
3729 8	CALBE DISP.ASSEMBLES WITH 8RO.	1

VARO Dispenser Systems

Fuel Hose Dispenser System

- Robust roll holder made of sheet steel for individual storage of FÖRCH fuel hose rolls
- Including special cutter
- Front guidance avoids hose slipping back
- Suitable for all FÖRCH perforated panels and for the VARO racking system
- Colour: RAL 5003

Contents:

Article No.	Article Description	Quantity
1318 35 95	RD.PH SH.MET.SC.7981 GA3.5X9.5	1
1318 42 95	RD.PH SH.MET.SC.7981 GA4.2X9.5	3
3404 10 40	CHAIN FOR HOSE SCISSORS 40CM	1
3799 4	PERFORATED PANEL FOR DISPENSER	1
3799 5	DISPENSER W.WOOD AXLE 130MM	3
4760 9	COMBI-HOSE SHEARS 190MM	1
5980 990	SET FOR DISPENSER SYSTEM	1



Article No.	Article Description	QTY
3905 1	FUEL HOSE DISPENS.SYSTEM	1

Dispenser System for Fuel Hose / Abrasive Paper

- Solid roll holder made of sheet steel with enclosed wooden axle for individual mounting
- Suitable for all FÖRCH perforated panels and VARO racking systems
- Tear-off edge for abrasive paper
- Can be fitted optionally
- Colour: RAL 5003

Art. No. 3799 5:

- Suitable for fuel hoses, slipping paper, abrasive sheets, abrasive fleece

Art. No. 3799 6:

- Suitable for abrasive cloth
- AGR 5980: 40 mm width
- AGR 5981: 50 mm width
- AGR 5982: 60 mm width

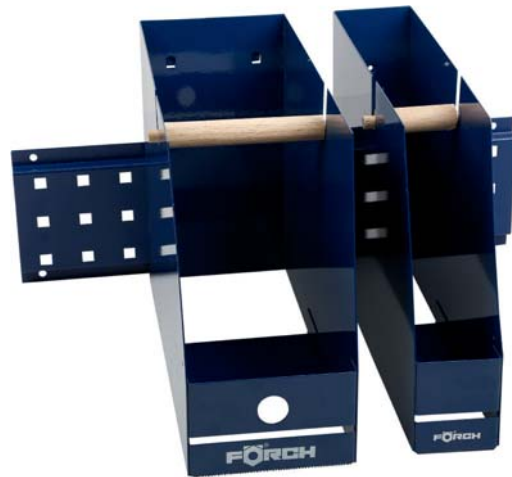

Article No.	Article Description	QTY
3799 4	PERFORATED PANEL FOR DISPENSER	1
3799 5	DISPENSER W.WOOD AXLE 130MM	1
3799 6	DISPENSER F.DISC/SHEETS 65MM	1
3799 5 1	WOOD.AXLE FOR DISPENSER 140MM	1
3799 6 1	VARO-ROLL HOLDER SHAFT 74MM	1

Dispenser for Dry Abrasive Paper

Contents:

Article No.	Article Description	Quantity
1318 42 95	RD.PH SH.MET.SC.7981 GA4.2X9.5	3
1611 6 40	PAN-H.PZ3-SPS ZI 6X 40	4
3799 4	PERFORATED PANEL FOR DISPENSER	1
3799 5	DISPENSER W.WOOD AXLE 130MM	3
8000 8	NYLON-EXPANSION ANCHOR F 8	4

Article No.	Article Description	QTY
5925 1	VARO-DISPENSER FOR ABRASIVES	1



Dispenser 5-fold, Empty

Contents:

Article No.	Article Description	Quantity
3799 4	PERFORATED PANEL FOR DISPENSER	1
3799 5	DISPENSER W.WOOD AXLE 130MM	1
3799 6	DISPENSER F.DISC/SHEETS 65MM	4
5980 990	SET FOR DISPENSER SYSTEM	1

Article No.	Article Description	QTY
5980 5	FÖRCH - DISPENSER 5-FOLD EMPTY	1



Safety Cabinet Type 90 / 1200

- Overall construction tested and approved by recognised material-testing institution in accordance with DIN EN 14470-1 (Type 90)
- Fire resistance of > 90 minutes
- GS-tested safety (GS symbol)
- Insulation in accordance with DIN 4102
- Sheet-steel outer body, powder coating in RAL 7035 – light grey, doors RAL 1007 – daffodil yellow
- Inner body made from HPL coated plates – RAL 7035
- Stainless steel floor end rail
- Mesh shelves – 64 mm, height adjustable
- Automatic self-closing of the doors by thermal mechanics when fire occurs
 - Doors for temperature increase $\leq 50^\circ$
 - Supply and exhaust air ducts for temperature increase to 70°C ($\pm 10^\circ\text{C}$)
- Ventilation connection by DN 80 pipe sockets
- Operation according to TRGS 510 (also approved without exhaust air)
- Earthing connection in accordance with TRBS 2153 (avoidance of ignition sources)
- Labelling according to DIN EN 14470-1 / TRGS 510 / ISO 3864 / ASR A1.3
- Levelling feet to compensate for uneven flooring
- Doors can be locked by cylinder lock



Technical Data

Safety cabinet Type 90:

External dimensions (W x D x H): 1,190 x 598 x 1,935 mm

Internal dimensions (W x D x H): 1,087 x 430 x 1,700 mm

Weight: 505 kg

Swing doors: 2

Air vent Ø: 80 mm

Article No.	Article Description	QTY
9071 90 1200	SAFETY CABINET TYPE 90/1200	1
9071 90 1200 3	DRIVE BASE FOR CABINET 90S/S90	1
9071 90 1200 5	SHELF TYPE 90/1200	1

Hazardous Substance Filter Attachment, Basic

- For the technical ventilation of safety cabinet type 90 in accordance with DIN EN 14470-1
- Reacts to coarse particulate contamination such as dust and heavy pollution of the exhaust air with hydrocarbon vapours and gases
- Warnings displayed by LED when saturation occurs
- Cabinet exhaust air is cleaned of hydrocarbon vapours by integrated active carbon filters and returned to the room air
- Filter is constructed in a tandem design. If the main filter is saturated, the second integrated filter ensures additional safety over a time period of around 14 days.
- The use of a GFA eliminates the compliance with an explosive zone around the safety cabinet
- Exhaust air line to the outdoors and the associated installation work can be omitted
- No pollution of the room air thanks filtering of almost 100% of all solvent fumes
- Increased employee health protection
- Low servicing and maintenance costs

Note:

- To ensure that the filter system is operating correctly, the GFA should be inspected for correct function and serviced at least once a year by a qualified person.
- The tandem active carbon filter must be replaced as part of the inspection



Technical Data

Housing:	Powder-coated sheet steel
Colour:	Light grey RAL 7035
Dimensions (W x D x H):	310 x 510 x 210 mm
Motor power:	0.03 kW
Rated voltage:	230 V
Frequency:	50 Hz
Current consumption:	0.2 A
Noise level:	
Empty weight:	13 kg
Volumetric flow:	25 m ³ /h

Article No.	Article Description	QTY
9071 90 1200 1	HAZ.SUBST.FILT.ATTACHM.BASIC	1

Adaptor For Safety Cabinet Type 90

Article No.	Article Description	QTY
9071 90 1200 2	ADAPTOR F.TYPE 30/90 CABINETS	1



Exhaust Air Fan for Safety Cabinet Type 90 / 1200

- Suitable for installation on the safety cabinet
- Simple connection of the fan (suction side) with aluminium flexi-hose Ø 80 mm

Note:

- Not suitable for floor exhaust units

Article No.	Article Description	QTY
9071 90 1200 4	EXHAUST AIR FAN MODEL 4	1

Delivery includes:

- 1x aluminium flexi-hose, Ø 80 mm
- 1x earthed socket with 2 m connection cable



Tool Cabinet with Swing Doors

- Neat steel sheet construction
- Body and doors with high-quality paint finish
- Swing doors with central door reinforcement mounted on pivot pins and three-point round handle lock with 2 keys
- 4 galvanised shelves, adjustable in 30 mm steps
- Load per shelf: 50 kg with load evenly distributed
- Cabinet body: light grey RAL 7035
- Cabinet door: light grey (RAL 7035), light blue (RAL 5012)

Dimension:

- (H x W x D): 1,950 x 940 x 400 mm

Article No.	Article Description	QTY
9409 150	TOOL CABINET GREY RAL 7035	1
9409 160	TOOLCABINET GREY/BLUE	1



9409 150



9409 160

FÖRCH Storage System

- Space saving storing for workshops, stocks, assembly of vehicles and service

Safety Case for 5 Sets

- Stackable
- Dimensions (W x H x D): 416 x 434 x 256 mm
- Centrally locking
- Every drawer is fitted with smooth-action telescopic runners and individual ant-tilt protector

Article No.	Article Description	QTY
9020 5	SAFETY CASE FOR 5 SETS	1



Safety Case with Carrying Handle for 3 Sets

- Without contents, stackable
- Suitable for mobile use
- Dimensions (W x H x D): 416 x 295 x 256 mm
- Centrally locking
- Every drawer is fitted with smooth-action telescopic runners and individual ant-tilt protector

Article No.	Article Description	QTY
9020 3	SAFE.CASE W.CARRY.HA.FOR 3SETS	1



Assortment Boxes, Standard Trays for Assortment Boxes

- Stable metal boxes, powder coated
- Dimensions (W x H x D): 340 x 50 x 240 mm
- With easy accessible and rounded plastic trays
- With manageable handles for the transport to the workplace
- 2 sideways arranged latches reliably prevent an unintentional opening of the cap

- Plastic trays without assortment box

Article No.	Article Description	QTY
9025 4	ASSORTMENT BOX F 4 EMPTY	1
9025 5	ASSORTMENT BOX F 5 EMPTY	1
9025 8	ASSORTMENT BOX F 8 EMPTY	1
9025 10	ASSORTMENT BOX F10 EMPTY	1
9025 11	ASSORTMENT BOX F11 EMPTY	1
9025 12	ASSORTMENT BOX F12 EMPTY	1
9025 14	ASSORTMENT BOX F14 EMPTY	1
9025 18	ASSORTMENT BOX F18 EMPTY	1
9025 20	ASSORTMENT BOX F20 EMPTY	1
9025 90	ASSORTMENT BOX WITHOUT TRAY	1

Article No.	Article Description	QTY
9026 4 1	TRAY 4-FOLD	1
9026 5	TRAY 5-FOLD	1
9026 8	TRAY 8-FOLD	1
9026 10	TRAY 10-FOLD	1
9026 11	TRAY 11-FOLD	1
9026 12	TRAY 12-FOLD	1
9026 14	TRAY 14-FOLD	1
9026 18	TRAY 18-FOLD	1
9026 20	TRAY 20-FOLD	1



Assortments

- Broad product range
- Space-saving and clearly laid out
- Handy carrying handles for transporting to the workplace
- The turn lock reliably prevents inadvertent opening of the cover
- Sturdy metal case, powder coated, with easy to access rounded plastic inserts



Sheet Metal Screws DIN 7981 C, GA, Assortment

• 2.9 × 9.5–4.8 × 25 = 1,700 pieces

Contents:

Article No.	Article Description	Quantity
1311 29 95	SELF-TAP.SCREW 7981 GA 2.9X9.5	100
1311 29 13	PH PANHD TAPSCR 7981GA 2.9X 13	100
1311 35 95	SELF-TAP.SCREW 7981 GA 3.5X9.5	100
1311 35 13	SELF-TAP.SCREW 7981 GA 3.5X 13	100
1311 35 16	SELF-TAP.SCREW 7981 GA 3.5X 16	100
1311 35 19	SELF-TAP.SCREW 7981 GA 3.5X 19	100
1311 39 13	SELF-TAP.SCREW 7981 GA 3.9X 13	100
1311 39 16	SELF-TAP.SCREW 7981 GA 3.9X 16	100
1311 39 19	OV.PH SH.MET.SCR.7981 GA3.9X19	100
1311 39 22	SELF-TAP.SCREW 7981 GA 3.9X 22	100
1311 42 13	SELF-TAP.SCREW 7981 GA 4.2X 13	100
1311 42 16	SELF-TAP.SCREW 7981 GA 4.2X 16	100
1311 42 19	SELF-TAP.SCREW 7981 GA 4.2X 19	100
1311 42 25	SELF-TAP.SCREW 7981 GA 4.2X 25	50
1311 48 13	OV.PH SH.MET.SCR.7981 GA4.8X13	100
1311 48 16	OV.PH SH.MET.SCR.7981 GA4.8X16	100
1311 48 19	OV.PH SH.MET.SCR.7981 GA4.8X19	100
1311 48 25	PH PANHD TAPSCR 7981GA 4.8X 25	50



Article No.	Article Description	QTY
9000 1311	ASS.PAN HD SELF TAP.SCR7981 ZN	1
9000R 1311	TRAY PAN HD S.TAPP.SCR.7981 ZN	1

Sheet Metal Screws DIN 7983, GA, Assortment

• 2.9 × 13 – 4.8 × 25 = 1,700 pieces

Contents:

Article No.	Article Description	Quantity
1331 29 13	PH RSD CSK TAP.7983 GA 2.9X13	100
1331 29 16	PH RSD CSK TAP.7983 GA 2.9X16	100
1331 35 13	PH RSD CSK TAP.7983 GA 3.5X13	100
1331 35 16	PH RSD CSK TAP.7983 GA 3.5X16	100
1331 35 19	PH RSD CSK TAP.7983 GA 3.5X19	100
1331 35 22	PH RSD CSK TAP.7983 GA 3.5X22	100
1331 39 13	OV.PH SH.MET.SCR.7983 GA3.9X13	100
1331 39 16	OV.PH SH.MET.SCR.7983 GA3.9X16	100
1331 39 19	OV.PH SH.MET.SCR.7983 GA3.9X19	100
1331 39 22	PH RSD CSK TAP.7983 GA 3.9X22	100
1331 42 13	OV.PH SH.MET.SCR.7983 GA4.2X13	100
1331 42 16	OV.PH SH.MET.SCR.7983 GA4.2X16	100
1331 42 19	OV.PH SH.MET.SCR.7983 GA4.2X19	100
1331 42 25	PH RSD CSK TAP.7983 GA 4.2X25	50
1331 48 13	OV.PH SH.MET.SCR.7983 GA4.8X13	100
1331 48 16	OV.PH SH.MET.SCR.7983 GA4.8X16	100
1331 48 19	OV.PH SH.MET.SCR.7983 GA4.8X19	100
1331 48 25	PH RSD CSK TAP.7983 GA 4.8X25	50



Article No.	Article Description	QTY
9000 1331	ASS.RAISED CSK SCREW 7983 ZINC	1
9000R 1331	TRAY RAISED CSK SCREW 7983 ZN	1

Sheet Metal Screws DIN 7981 / 7983, GA, Assortment

- 3.5 × 9.5 – 4.8 × 22 = 1,600 pieces

Contents:

Article No.	Article Description	Quantity
1311 35 95	SELF-TAP.SCREW 7981 GA 3.5X9.5	100
1311 35 13	SELF-TAP.SCREW 7981 GA 3.5X 13	100
1311 35 16	SELF-TAP.SCREW 7981 GA 3.5X 16	100
1311 35 19	SELF-TAP.SCREW 7981 GA 3.5X 19	100
1311 42 13	SELF-TAP.SCREW 7981 GA 4.2X 13	100
1311 42 16	SELF-TAP.SCREW 7981 GA 4.2X 16	100
1311 42 19	SELF-TAP.SCREW 7981 GA 4.2X 19	100
1311 42 22	SELF-TAP.SCREW 7981 GA 4.2X 22	50
1311 48 13	OV.PH SH.MET.SCR.7981 GA4.8X13	100
1311 48 16	OV.PH SH.MET.SCR.7981 GA4.8X16	100
1311 48 19	OV.PH SH.MET.SCR.7981 GA4.8X19	100
1311 48 22	OV.PH SH.MET.SCR.7981 GA4.8X22	50
1331 35 16	PH RSD CSK TAP.7983 GA 3.5X16	100
1331 35 19	PH RSD CSK TAP.7983 GA 3.5X19	100
1331 42 16	OV.PH SH.MET.SCR.7983 GA4.2X16	100
1331 42 22	OV.PH SH.MET.SCR.7983 GA4.2X22	50
1331 48 19	OV.PH SH.MET.SCR.7983 GA4.8X19	100
1331 48 22	OV.PH SH.MET.SCR.7983 GA4.8X22	50

Article No.	Article Description	QTY
9000 131	ASS.SH.MET.SCREWS 7981/7983 GA	1
9000R 131	TRAY SH.MET.SCREW.7981/7983 GA	1



Sheet Metal Screws DIN 7981, Black GA, Assortment

- According to ISO 7049
- 2.9 × 9.5 – 4.8 × 25 = 1,700 pieces

Contents:

Article No.	Article Description	Quantity
1313 29 95	PH PANHD TAPSCR 7981BGA2.9X9.5	100
1313 29 13	PH PANHD TAPSCR 7981BGA2.9X13	100
1313 35 95	PH PANHD TAPSCR 7981BGA3.5X9.5	100
1313 35 13	OV.PH SH.MET.SCR.7981BGA3.5X13	100
1313 35 16	PH PANHD TAPSCR 7981BGA3.5X16	100
1313 35 19	OV.PH SH.MET.SCR.7981BGA3.5X19	100
1313 39 13	OV.PH SH.MET.SCR.7981BGA3.9X13	100
1313 39 16	OV.PH SH.MET.SCR.7981BGA3.9X16	100
1313 39 19	OV.PH SH.MET.SCR.7981BGA3.9X19	100
1313 39 22	PH PANHD TAPSCR 7981BGA3.9X22	100
1313 42 13	OV.PH SH.MET.SCR.7981BGA4.2X13	100
1313 42 16	OV.PH SH.MET.SCR.7981BGA4.2X16	100
1313 42 19	OV.PH SH.MET.SCR.7981BGA4.2X19	100
1313 42 25	PH PANHD TAPSCR 7981BGA4.2X25	50
1313 48 13	OV.PH SH.MET.SCR.7981BGA4.8X13	100
1313 48 16	OV.PH SH.MET.SCR.7981BGA4.8X16	100
1313 48 19	OV.PH SH.MET.SCR.7981BGA4.8X19	100
1313 48 25	PH PANHD TAPSCR 7981BGA4.8X25	50

Article No.	Article Description	QTY
9000 1313	ASS TRIM S/T SCREW 7981 BGA	1
9000R 1313	TRAY TRIM S/T SCREW 7981 BGA	1



Sheet Metal Screws DIN 7983, Black GA, Assortment

- 2.9 × 13 – 4.8 × 25 = 1,700 pieces

Contents:

Article No.	Article Description	Quantity
1333 29 13	PH RSD CSK TAP.7983 BGA2.9X13	100
1333 29 16	PH RSD CSK TAP.7983 BGA2.9X16	100
1333 35 13	OV.PH SH.MET.SCR.7983BGA3.5X13	100
1333 35 16	PH RSD CSK TAP.7983 BGA3.5X16	100
1333 35 19	OV.PH SH.MET.SCR.7983BGA3.5X19	100
1333 35 22	PH RSD CSK TAP.7983 BGA3.5X22	100
1333 39 13	PH RSD CSK TAP.7983 BGA3.9X13	100
1333 39 16	OV.PH SH.MET.SCR.7983BGA3.9X16	100
1333 39 19	PH RSD CSK TAP.7983 BGA3.9X19	100
1333 39 22	OV.PH SH.MET.SCR.7983BGA3.9X22	100
1333 42 13	OV.PH SH.MET.SCR.7983BGA4.2X13	100
1333 42 16	OV.PH SH.MET.SCR.7983BGA4.2X16	100
1333 42 19	OV.PH SH.MET.SCR.7983BGA4.2X19	100
1333 42 25	PH RSD CSK TAP.7983 BGA4.2X25	50
1333 48 13	PH RSD CSK TAP.7983 BGA4.8X13	100
1333 48 16	PH RSD CSK TAP.7983 BGA4.8X16	100
1333 48 19	OV.PH SH.MET.SCR.7983BGA4.8X19	100
1333 48 25	PH RSD CSK TAP.7983 BGA4.8X25	50

Article No.	Article Description	QTY
9000 1333	ASS.SH.MET.SCREW DIN7983 BLACK	1
9000R 1333	TRAY SH.MET.SCRE.DIN7983 BLACK	1



Sheet Metal Screws DIN7981 / 7983, Black GA, Ass.

• 3.5 × 9.5 – 4.8 × 22 = 1,600 pieces

Contents:

Article No.	Article Description	Quantity
1313 35 95	PH PANHD TAPSCR 7981BGA3.5X9.5	100
1313 35 13	OV.PH SH.MET.SCR.7981BGA3.5X13	100
1313 35 16	PH PANHD TAPSCR 7981BGA3.5X16	100
1313 35 19	OV.PH SH.MET.SCR.7981BGA3.5X19	100
1313 42 13	OV.PH SH.MET.SCR.7981BGA4.2X13	100
1313 42 16	OV.PH SH.MET.SCR.7981BGAP4.2X16	100
1313 42 19	OV.PH SH.MET.SCR.7981BGA4.2X19	100
1313 42 22	OV.PH SH.MET.SCR.7981BGA4.2X22	50
1313 48 13	OV.PH SH.MET.SCR.7981BGA4.8X13	100
1313 48 16	OV.PH SH.MET.SCR.7981BGA4.8X16	100
1313 48 19	OV.PH SH.MET.SCR.7981BGA4.8X19	100
1313 48 22	OV.PH SH.MET.SCR.7981BGA4.8X22	50
1333 35 16	PH RSD CSK TAP.7983 BGA3.5X16	100
1333 35 19	OV.PH SH.MET.SCR.7983BGA3.5X19	100
1333 42 16	OV.PH SH.MET.SCR.7983BGA4.2X16	100
1333 42 22	PH RSD CSK TAP.7983 BGA4.2X22	50
1333 48 19	OV.PH SH.MET.SCR.7983BGA4.8X19	100
1333 48 22	PH RSD CSK TAP.7983 BGA4.8X22	50



Article No.	Article Description	QTY
9000 132	ASS.SH.M.SCREW 9781/7983 BGA	1
9000R 132	TRAY SH.M.SCREW 9781/7983 BGA	1

Sheet Metal Screws DIN 968, Black GA, Assortment

• 3.5 × 9.5 – 4.8 × 25 = 1,650 pieces

Contents:

Article No.	Article Description	Quantity
1318 35 95	RD.PH SH.MET.SC.7981 GA3.5X9.5	100
1318 35 13	RD.PH SH.MET.SCR.7981 GA3.5X13	100
1318 35 16	RD.PH SH.MET.SCR.7981 GA3.5X16	100
1318 35 19	RD.PH SH.MET.SCR.7981 GA3.5X19	100
1318 39 13	RD.PH SH.MET.SCR.7981 GA3.9X13	100
1318 39 16	RD.PH SH.MET.SCR.7981 GA3.9X16	100
1318 39 19	RD.PH SH.MET.SCR.7981 GA3.9X19	100
1318 39 22	RD.PH SH.MET.SCR.7981 GA3.9X22	50
1318 42 95	RD.PH SH.MET.SC.7981 GA4.2X9.5	100
1318 42 13	RD.PH SH.MET.SCR.7981 GA4.2X13	100
1318 42 16	RD.PH SH.MET.SCR.7981 GA4.2X16	100
1318 42 19	RD.PH SH.MET.SCR.7981 GA4.2X19	100
1318 42 22	RD.PH SH.MET.SCR.7981 GA4.2X22	100
1318 42 25	RD.PH SH.MET.SCR.7981 GA4.2X25	50
1318 48 13	RD.PH SH.MET.SCR.7981 GA4.8X13	100
1318 48 16	RD.PH SH.MET.SCR.7981 GA4.8X16	100
1318 48 19	RD.PH SH.MET.SCR.7981 GA4.8X19	100
1318 48 25	RD.PH SH.MET.SCR.7981 GA4.8X25	50



Article No.	Article Description	QTY
9000 1318	ASS TRIM S/T SCREW 7981 BGA	1
9000R 1318	TRAY TRIM S/T SCREW 7981 BGA	1

Self Tapping Screws with Drill Tip, Assortment

• 4.2 × 13 – 4.8 × 32 = 1,000 pieces

Contents:

Article No.	Article Description	Quantity
1319 42 13	DIN 968CT PAN HEAD BZP 4.2X13	100
1319 42 16	DIN 968CT PAN HEAD BZP 4.2X16	100
1319 42 19	DIN 968CT PAN HEAD BZP 4.2X19	100
1319 42 25	DIN 968CT PAN HEAD BZP 4.2X25	100
1319 42 32	DIN 968CT PAN HEAD BZP 4.2X32	100
1319 48 13	DIN 968CT PAN HEAD BZP 4.8X13	100
1319 48 16	DIN 968CT PAN HEAD BZP 4.8X16	100
1319 48 19	DIN 968CT PAN HEAD BZP 4.8X19	100
1319 48 22	DIN 968CT PAN HEAD BZP 4.8X22	100
1319 48 32	DIN 968CT PAN HEAD BZP 4.8X32	100



Article No.	Article Description	QTY
9000 1319	ASSORT.TAPP.SCREWS W.DRILL TIP	1
9000R 1319	INLAY SELF TAPP.SCR W.DR.TIP	1

Self-drilling Screws DIN 7504 K, Assortment

• 4.2×13–6.3×32 = 1,000 pieces

Contents:

Article No.	Article Description	Quantity
1350 42 13	HEX SD SCR. 7504K ZP 4.2X13	100
1350 42 16	HEX SD SCR. 7504K ZP 4.2X16	100
1350 42 19	HEX SD SCR. 7504K ZP 4.2X19	100
1350 48 16	HEX SD SCR. 7504K ZP 4.8X16	100
1350 48 19	HEX SD SCR. 7504K ZP 4.8X19	100
1350 48 25	HEX SD SCR. 7504K ZP 4.8X25	100
1350 55 19	HEX SD SCR. 7504K ZP 5.5X19	100
1350 55 25	HEX SD SCR. 7504K ZP 5.5X25	100
1350 55 32	HEX SD SCR. 7504K ZP 5.5X32	50
1350 63 19	HEX SD SCR. 7504K ZP 6.3X19	50
1350 63 25	HEX SD SCR. 7504K ZP 6.3X25	50
1350 63 32	HEX SD SCR. 7504K ZP 6.3X32	50
9801 24	VPK-SORTIMENT345X262X73 NR.24	1

Article No.	Article Description	QTY
9000 1350	ASS:SELF-DRILL.SCR.7504 K GAL.	1
9000R 1350	INTR.SELF-DRILL.SCR.7504K GAL.	1



Self-Tapping Screws DIN 7504 N (M), GA Assortment

• 3.5 × 9.5 – 4.8 × 19 = 1,200 pieces

Contents:

Article No.	Article Description	Quantity
1351 35 95	PAN HD SD SCR. 7504M GA3.5X9.5	100
1351 35 16	PAN HD SD SCR. 7504M GA 3.5X16	100
1351 35 19	PAN HD SD SCR. 7504M GA 3.5X19	100
1351 39 13	PAN HD SD SCR. 7504M GA 3.9X13	100
1351 39 16	PAN HD SD SCR. 7504M GA 3.9X16	100
1351 39 19	PAN HD SD SCR. 7504M GA 3.9X19	100
1351 42 13	PAN HD SD SCR. 7504M GA 4.2X13	100
1351 42 16	PAN HD SD SCR. 7504M GA 4.2X16	100
1351 42 19	PAN HD SD SCR. 7504M GA 4.2X19	100
1351 42 25	PAN HD SD SCR. 7504M GA 4.2X25	100
1351 48 16	PAN HD SD SCR. 7504M GA 4.8X16	100
1351 48 19	PAN HD SD SCR. 7504M GA 4.8X19	100

Article No.	Article Description	QTY
9000 1351	ASS.PH SELF-TAPP.SCR.7504 M GA	1
9000R 1351	TRAY PH SELF-TAP.SCR.7504 M GA	1



Self-drilling Screws DIN 7504 P, Assortment

• 3.5 × 13 – 4.8 × 32 = 1,200 pieces

Contents:

Article No.	Article Description	Quantity
1352 35 13	PH CSK SD SCR.7504-O ZP 3.5X13	100
1352 35 16	PH CSK SD SCR.7504-O ZP 3.5X16	100
1352 35 19	PH CSK SD SCR.7504-O ZP 3.5X19	100
1352 39 13	PH CSK SD SCR.7504-O ZP 3.9X13	100
1352 39 16	PH CSK SD SCR.7504-O ZP 3.9X16	100
1352 39 19	PH CSK SD SCR.7504-O ZP 3.9X19	100
1352 42 16	PH CSK SD SCR.7504-O ZP 4.2X16	100
1352 42 19	PH CSK SD SCR.7504-O ZP 4.2X19	100
1352 42 25	PH CSK SD SCR.7504-O ZP 4.2X25	100
1352 48 19	PH CSK SD SCR.7504-O ZP 4.8X19	100
1352 48 25	PH CSK SD SCR.7504-O ZP 4.8X25	100
1352 48 32	PH CSK SD SCR.7504-O ZP 4.8X32	100

Article No.	Article Description	QTY
9000 1352	ASS.SELF-DRILL.SCR.7504P GALV.	1
9000R 1352	INT.SELF-DRILL.SCR.7504P GALV.	1



Sheet Metal Screw with Washer, Zinc-Coated, Ass.

• 4.2 × 13 – 6.5 × 20 = 450 pieces

Contents:

Article No.	Article Description	Quantity
1302 42 13	COM.HD TAPP.SCR.WASH ZN 4.2X13	50
1302 48 16	COM.SH.MET.SCR.W.WASH.ZN4.8X16	50
1302 48 19	COM.SH.MET.SCR.W.WASH.ZN4.8X19	50
1302 56 16	COM.SH.MET.SCR.W.WASH.ZN5.6X16	50
1302 63 16	COM.HD TAP.SC.WASH ZN6.3X16-22	50
1302 65 16	COM.SH.MET.SCR.W.WASH.ZN6.5X16	50
1302 65 20	COM.SH.MET.SCR.W.WASH.ZN6.5X20	150

Article No.	Article Description	QTY
9000 1302	ASS.HEX HD SH.MET.SCR.W.CAP.WA	1
9000R 1302	TRAY HEX HD SH.MET.SC.W.CAP.WA	1



Oil Drain Plugs in Assortment

• 105 pieces

Contents:

Article No.	Article Description	Quantity
1139 1 12	BMW OIL DRAIN PLUG 12X1.5X18	5
1139 2 12	DB OIL DRAIN PLUG 12X1.5X12	5
1139 2 14 2	MB OIL DR.PL.M14X1.5X24BK13DP	5
1139 3 14	FORD OIL DRAIN PLUG M14X1.5X16	5
1139 3 14 1	FORD OIL DR.PLUG 14X1.5X21 W.W	5
1139 4 14	OPEL O.DRA.PLUG M14X1.5X10TX45	5
1139 4 14 1	OPEL OIL D.PLUG M14X1.5X12SW19	5
1139 4 16	OPEL OIL DRAIN PLUG M16X1.5X9	5
1139 4 18	OPEL OIL DRAIN PLUG M18X1.5X10	5
1139 5 14	VW/AUDI OIL DR.PLUG M14X1.5X11	5
1139 5 14 1	VW/A.OIL DR.PLUG M14X1.5X21 CW	5
1139 6 12	NISS.OIL DR.PL.M12X1.25X13SW14	5
2600 12 18	SEAL.RING 7603 A CO 12X18X1.5	5
2600 14 20	SEAL.RING 7603 A CO 14X20X1.5	20
2600 16 22	SEAL.RING 7603 A CO 16X22X1.5	5
2620 12 18	SEAL.RING 7603 A ALU 12X18X1.5	5
2641 14	FD-SEA.RING ST/RUB.14.7X24X1.5	5
2667 11 17	NISSAN SEALING RING CU 11X17X3	5



Article No.	Article Description	QTY
9000 1139	ASS. SUMP OIL DRAIN PLUGS	1
9000R 1139	TRAY SUMP OIL DRAIN PLUGS	1

Hex Head Screws DIN 933 8.8 GA, Assortment

• M6 x 16 – M10 x 40 = 470 pieces

Contents:

Article No.	Article Description	Quantity
1011 6 16	HEX HD M.SCREW933 8.8 GA 6X 16	50
1011 6 20	HEX HD M.SCREW933 8.8 GA 6X 20	50
1011 6 25	HEX HD M.SCREW933 8.8 GA 6X 25	50
1011 6 30	HEX HD SCR. 933 8.8 GA 6X 30	50
1011 8 16	HEX HD SCR. 933 8.8 GA 8X 16	50
1011 8 20	HEX HD SCREW933 8.8 GA 8X 20	50
1011 8 25	HEX HD M.SCREW933 8.8 GA 8X 25	50
1011 8 40	HEX HD M.SCREW933 8.8 GA 8X 40	25
1011 10 20	HEX HD SCR. 933 8.8 GA 10X 20	25
1011 10 25	HEX HD M.SCREW933 8.8 GA 10X25	25
1011 10 30	HEX HD M.SCREW933 8.8 GA 10X30	25
1011 10 40	HEX HD M.SCREW933 8.8 GA 10X40	20

Article No.	Article Description	QTY
9000 1011	ASS.HEX HEAD SCREWS 933 8.8 ZI	1
9000R 1011	INTRAY HEX.HD SCR.933 8.8 GAL.	1



Slotted Cheese HD Screw DIN 84, GA, Assortment

• M4 x 10 – M6 x 25 = 1,150 pieces

Contents:

Article No.	Article Description	Quantity
1201 4 10	SL.CHEESE HD SCR. 84 GA 4X10	100
1201 4 16	SL.CHEESE HD SCR. 84 GA 4X16	100
1201 4 20	SL.CHEESE HD SCR. 84 GA 4X20	100
1201 4 30	SL.CHEESE HD SCR. 84 GA 4X30	100
1201 5 10	SL.CHEESE HD SCR. 84 GA 5X10	100
1201 5 16	SL.CHEESE HD SCR. 84 GA 5X16	100
1201 5 20	SL.CHEESE HD SCR. 84 GA 5X20	100
1201 5 30	SL.CHEESE HD SCR. 84 GA 5X30	100
1201 6 10	SL.CHEESE HD SCR. 84 GA 6X10	100
1201 6 16	SL.CHEESE HD SCR. 84 GA 6X16	100
1201 6 20	SL.CHEESE HD SCR. 84 GA 6X20	100
1201 6 25	SL.CHEESE HD SCR. 84 GA 6X25	50

Article No.	Article Description	QTY
9000 1201	ASS.SLT CHEESE HD SCREWS 84 ZN	1
9000R 1201	TRAY SLT.CHEESE HD SCR.84 ZINC	1



Flat Pan Head Screw DIN 7985, GV, Assortment

• M4 × 10 – M6 × 25 = 950 pieces

Contents:

Article No.	Article Description	Quantity
1231 4 10	OVAL HEAD SCREW 7985 GA 4X 10	100
1231 4 20	OVAL HD SCREW 7985 GA 4X 20	100
1231 4 25	PH PAN HD SCR. 7985 ZP 4X 25	100
1231 4 30	OVAL HD SCREW 7985 GA 4X 30	100
1231 5 10	PH PAN HD SCR. 7985 ZP 5X 10	100
1231 5 20	OVAL HD SCREW 7985 GA 5X 20	100
1231 5 25	PH PAN HD SCR. 7985 ZP 5X 25	50
1231 5 30	OVAL HD SCREW 7985 GA 5X 30	50
1231 6 10	PH PAN HD SCR. 7985 ZP 6X 10	100
1231 6 16	OVAL HD SCREW 7985 GA 6X 16	50
1231 6 20	OVAL HD SCREW 7985 GA 6X 20	50
1231 6 25	PH PAN HD SCR. 7985 ZP 6X 25	50

Article No.	Article Description	QTY
9000 1231	ASS FLAT PH.HD SCREWS 7985 ZN	1
9000R 1231	TRAY PH.HD MACH.SCREWS 7985 ZN	1



Flat Head Countersunk Screw DIN 965 GA, Assortment

• M4 × 10 – M6 × 25 = 1,000 pieces

Contents:

Article No.	Article Description	Quantity
1241 4 10	PH COUNT HD SCR. 965 ZP 4X10	100
1241 4 16	PH COUNT HD SCR. 965 ZP 4X16	100
1241 4 20	PH COUNT HD SCR. 965 ZP 4X20	100
1241 4 30	PH COUNT HD SCR. 965 ZP 4X30	100
1241 5 10	PH COUNT HD SCR. 965 ZP 5X10	100
1241 5 16	PH COUNT HD SCR. 965 ZP 5X16	100
1241 5 20	PH COUNT HD SCR. 965 ZP 5X20	100
1241 5 30	PH COUNT HD SCR. 965 ZP 5X30	50
1241 6 10	PH COUNT HD SCR. 965 ZP 6X10	100
1241 6 16	PH COUNT HD SCR. 965 ZP 6X16	50
1241 6 20	PH COUNT HD SCR. 965 ZP 6X20	50
1241 6 25	PH COUNT HD SCR. 965 ZP 6X25	50
	VPK-SORTIMENT345X262X73 NR.24	1

Article No.	Article Description	QTY
9000 1241	ASS.FLAT CSK HEAD SCREW 965 ZN	1
9000R 1241	TRAY FLAT CSK HD SCREW 965 ZN	1



Nuts, Washers, Spring Lock Washers, GA, Assortment

• M4, M5, M6, M8 = 2,550 pieces

Contents:

Article No.	Article Description	Quantity
2001 4	HEX NUT 934-8 GA 4	300
2001 5	HEX NUT 934-8 GA 5	300
2001 6	HEX NUT 934-8 GA 6	300
2001 8	HEX NUT 934-8 GA 8	100
2301 4	WASHER 125 A GA 4	300
2301 5	WASHER 125 A GA 5	300
2301 6	WASHER 125 A GA 6	200
2301 8	WASHER 125 A GA 8	100
2501 4	SPRING WASHER 127 GA 4	300
2501 5	SPRING WASHER 127 GA 5	300
2501 6	SPRING WASHER 127 GA 6	300
2501 8	SPRING WASHER 127 GA 8	100



Article No.	Article Description	QTY
9000 2	ASS.934/125A/127 GALVANISED	1
9000R 2	INTRAY 934/125/127 GALVANISED	1

Nuts, Washers, Spring Rings, GA, Assortment

• M4, M5, M6, M8 = 3,000 pieces

Contents:

Article No.	Article Description	Quantity
2001 4	HEX NUT 934-8 GA 4	300
2001 5	HEX NUT 934-8 GA 5	300
2001 6	HEX NUT 934-8 GA 6	300
2001 8	HEX NUT 934-8 GA 8	100
2303 4	WASHER DIN 125 B GA 4	300
2303 5	WASHER DIN 125 B GA 5	300
2303 6	WASHER DIN 125 B GA 6	300
2303 8	WASHER DIN 125 B GA 8	100
2501 4	SPRING WASHER 127 GA 4	300
2501 5	SPRING WASHER 127 GA 5	300
2501 6	SPRING WASHER 127 GA 6	300
2501 8	SPRING WASHER 127 GA 8	100



Article No.	Article Description	QTY
9000 2 2303	ASS.934/125B/127 GALVANISED	1
9000R 2 2303	INTRAY 934/125B/127 GALVANISED	1

Washers DIN 9021, Galvanized, Assortment

- In compliance with ISO 7093
- For M4 – M16 = 545 pieces

Contents:

Article No.	Article Description	Quantity
2311 4	WASHER 9021 GA 4	100
2311 5	WASHER 9021 ZI 5	100
2311 6	WASHER 9021 ZI 6	100
2311 8	WASHER 9021 ZI 8	100
2311 10	WASHER 9021 ZI 10	50
2311 12	WASHER 9021 ZI 12	50
2311 14	WASHER 9021 ZI 14	25
2311 16	WASHER 9021 ZI 16	25



Article No.	Article Description	QTY
9000 2311	ASS.WASHERS DIN9021 GA	1
9000R 2311	TRAY WASHERS DIN9021 GA	1

Washers DIN 125 A, Galvanized in Assortment

- For M4 – M6 = 1,050 pieces

Contents:

Article No.	Article Description	Quantity
2301 4	WASHER 125 A GA 4	200
2301 5	WASHER 125 A GA 5	200
2301 6	WASHER 125 A GA 6	200
2301 8	WASHER 125 A GA 8	200
2301 10	WASHER 125 A GA 10	100
2301 12	WASHER 125 A GA 12	50
2301 14	WASHER 125 A GA 14	50
2301 16	WASHER 125 A GA 16	50



Article No.	Article Description	QTY
9000 2301	ASS.WASHERS DIN 125 A GA	1
9000R 2301	TRAY WASHER DIN125 A GA	1

Washers DIN 125 B, Galvanized in Assortment

- For M4 – M6 = 1,050 pieces

Contents:

Article No.	Article Description	Quantity
2303 4	WASHER DIN 125 B GA 4	200
2303 5	WASHER DIN 125 B GA 5	200
2303 6	WASHER DIN 125 B GA 6	200
2303 8	WASHER DIN 125 B GA 8	200
2303 10	WASHER DIN 125 B GA 10	100
2303 12	WASHER DIN 125 B GA 12	50
2303 14	WASHER DIN 125 B ZI 14	50
2303 16	WASHER DIN 125 B ZI 16	50



Article No.	Article Description	QTY
9000 2303	ASS.WASHERS DIN 125 B GA	1
9000R 2303	TRAY WASHERS 125 B GA	1

Spring Rings DIN 127, Galvanised, Assortment

- For M4 – M16 = 1,100 pieces

Contents:

Article No.	Article Description	Quantity
2501 4	SPRING WASHER 127 GA 4	200
2501 5	SPRING WASHER 127 GA 5	200
2501 6	SPRING WASHER 127 GA 6	200
2501 8	SPRING WASHER 127 GA 8	200
2501 10	SPRING WASHER 127 GA 10	100
2501 12	SPRING WASHER 127 GA 12	100
2501 14	SPRING WASHER 127 GA 14	50
2501 16	SPRING WASHER 127 GA 16	50

Article No.	Article Description	QTY
9000 2501	ASS.SPRING WASHER FORM B GALV.	1
9000R 2501	INTRAY SPRING RINGS 127 GALVA.	1



Hex Nuts DIN 934-8, Galvanized, Assortment

- M4 – M16 = 900 pieces

Contents:

Article No.	Article Description	Quantity
2001 4	HEX NUT 934-8 GA 4	200
2001 5	HEX NUT 934-8 GA 5	200
2001 6	HEX NUT 934-8 GA 6	200
2001 8	HEX NUT 934-8 GA 8	150
2001 10	HEX NUT 934-8 GA 10	50
2001 12	HEX NUT 934-8 GA 12	50
2001 14	HEX NUT 934-8 GA 14	25
2001 16	HEX NUT 934-8 GA 16	25
	VPK-SORTIMENT345X262X73 NR.24	1

Article No.	Article Description	QTY
9000 2001	ASS.HEX NUTS 934-8 GALVANIZED	1
9000R 2001	TRAY HEX NUTS 934-8 GALVANIZED	1



Hex. Nylock Nuts DIN 985-8, Galvanized, Assortment

• M4 – M16 = 650 pieces

Contents:

Article No.	Article Description	Quantity
2101 4	NYLOCK NUT 985-8 4	100
2101 5	NYLOCK NUT 985-8 5	100
2101 6	NYLOCK NUT 985-8 6	150
2101 8	NYLOCK NUT 985-8 8	150
2101 10	NYLOCK NUT 985-8 10	50
2101 12	NYLOCK NUT 985-8 12	50
2101 14	NYLOCK NUT 985-8 14	25
2101 16	NYLOCK NUT 985-8 16	25

Article No.	Article Description	QTY
9000 2101	ASS.HEX.NYLOCK NUTS 985-8 GA	1
9000R 2101	TRAY HEX.NYLOCK NUTS 985-8 GA	1



Hex Nylock Nuts DIN 985-10 Fine Thread, GA Assort.

• M8 x 1 – M16 x 1,5 = 270 pieces

Contents:

Article No.	Article Description	Quantity
2104 8 1	NYLOCK NUT 985-10 8X1	50
2104 10 1	NYLOCK NUT 985-10 10X1	50
2104 10 125	NYLOCK NUT 985-10 10X1.25	50
2104 12 1	NYLOCK NUT 985-10 12X1	25
2104 12 125	NYLOCK NUT 985-10 12X1.25	25
2104 12 15	NYLOCK NUT 985-10 12X1.5	25
2104 14 15	NYLOCK NUT 985-10 14X1.5	25
2104 16 15	NYLOCK NUT 985-10 16X1.5	20

Article No.	Article Description	QTY
9000 2104	HEX NYLOCK NUT985-10 FINE THR.	1
9000R 2104	TRAY HEX NYLOCK NUTS 985-10 GA	1



Nylock Nuts and Hex Nuts, Galvanized, Assortment

• M5 – M12 = 1,050 pieces

Contents:

Article No.	Article Description	Quantity
2001 5	HEX NUT 934-8 GA 5	200
2001 6	HEX NUT 934-8 GA 6	200
2001 8	HEX NUT 934-8 GA 8	150
2001 10	HEX NUT 934-8 GA 10	50
2001 12	HEX NUT 934-8 GA 12	50
2101 5	NYLOCK NUT 985-8 5	100
2101 6	NYLOCK NUT 985-8 6	100
2101 8	NYLOCK NUT 985-8 8	100
2101 10	NYLOCK NUT 985-8 10	50
2101 12	NYLOCK NUT 985-8 12	50



Article No.	Article Description	QTY
9000 21	ASS.NUTS+NYLOCKS 934/985 GA	1
9000R 21	TRAY NUTS+NYLOCKS 934/985 GA	1

Sheet-Metal Nuts, Galvanised, Assortment

• 2.9 – 6.5 = 650 pieces

Contents:

Article No.	Article Description	Quantity
2290 29	SHEET-MET.NUT 2.9 12.00X11.00	50
2290 35	SHEET-MET.NUT 3.5 16.50X11.00	50
2290 39	SHEET-MET.NUT 3.9 16.50X11.30	50
2290 42	SHEET-MET.NUT 4.2 16.50X11.20	50
2290 42 1	SHEET-MET.NUT 4.2 24.50X11.00	50
2290 48	SHEET-MET.NUT 4.8 16.00X14.50	50
2290 48 1	SHEET-MET.NUT 4.8 16.50X11.30	50
2290 48 2	SHEET-MET.NUT 4.8 18.25X16.00	50
2290 48 3	SHEET-MET.NUT 4.8 20.00X12.00	50
2290 56	SHEET-MET.NUT 5.6 20.20X13.30	50
2290 65	SHEET-MET.NUT 6.5 25.20X16.20	150



Article No.	Article Description	QTY
9000 2290	ASSORTMENT SHEET-METAL NUTS	1
9000R 2290	TRAY SHEET-METAL NUTS	1

Hose Clamps, Assortment

- 140 pieces

Contents:

Article No.	Article Description	Quantity
3202 8 12	CLAMP SGL 8MM SW6 W2 8-12	20
3202 10 16	CLAMP SGL 8MM SW6 W2 10-16	20
3210 7 11	MINIFLEX HOSE CLIP SX5 7-11MM	10
3210 11 19	MINIFLEX HOSE CLIP SX5 11-19M	10
3212 10	NORMA CLAMP B 9MM D 10MM	10
3212 11	NORMA CLAMP B 9MM D 11MM	10
3212 12	NORMA CLAMP B 9MM D 12MM	10
3212 13	NORMA CLAMP B 9MM D 13MM	10
3212 14	NORMA CLAMP B 9MM D 14MM	10
3212 15	NORMA CLAMP B 9MM D 15MM	10

Article No.	Article Description	QTY
9000 32	ASSORTMENT HOSE CLAMPS	1
9000R 32	TRAY HOSE CLAMPS	1



Cobra Hose Clamps, Assortment

- 7,5 – 16 mm = 195 pieces
- 1x Art. No. 3226 1: cobra hose clamp pliers

Contents:

Article No.	Article Description	Quantity
3226 1	COBRA HOSE CLAMP PLIERS	1
3226 75	HOSE CLAMP COBRA B7MM D 7.5MM	20
3226 85	HOSE CLAMP COBRA B7MM D 8.5MM	20
3226 9	HOSE CLAMP COBRA B7MM D 9MM	20
3226 95	HOSE CLAMP COBRA B7MM D 9.5MM	20
3226 10	HOSE CLAMP COBRA B7MM D 10MM	20
3226 11	HOSE CLAMP COBRA B7MM D 11MM	20
3226 12	HOSE CLAMP COBRA B8MM D 12MM	20
3226 13	HOSE CLAMP COBRA B8MM D 13MM	20
3226 14	HOSE CLAMP COBRA B8MM D 14MM	20
3226 16	HOSE CLAMP COBRA B8MM D 16MM	15

Article No.	Article Description	QTY
9000 3226	ASS. COBRA HOSE CLAMPS	1
9000R 3226	TRAY HOSE CLAMPS COBRA	1



Perforated Clips A2, Assortment

- Perforated clips A2 in assortment box

Contents:

Article No.	Article Description	Quantity
3102 4000	CLAMP.PLIERS F.PERFORATED CLIP	1
3236 25 50	PERFORATED CLIP A2 7/25-50MM	30
3236 40 110	PERFORATED CLIP A2 7/40-110MM	30

Article No.	Article Description	QTY
9000 25	ASS.PERFORATED CLIPS A2	1
9000R 25	TRAY PERFORATED CLIPS A2	1



Oetiker Hose Clamps in Assortment

- Type 95 – 185 = 190 pieces
- 1x Art. No. 4681 200: mechanic's nippers, length: 200 mm

Contents:

Article No.	Article Description	Quantity
3222 95	ÖTIKER ZERO CLAMP 7.5- 9.0 W4	20
3222 105	ÖTIKER ZERO CLAMP 8.5-10.0 W4	20
3222 113	ÖTIKER ZERO CLAMP 9.1-10.8 W4	20
3222 123	ÖTIKER ZERO CLAMP 9.8-11.8 W4	20
3222 133	ÖTIKER ZERO CLAMP 10.6-12.6 W4	20
3222 145	ÖTIKER ZERO CLAMP 11.8-13.8 W4	20
3222 155	ÖTIKER ZERO CLAMP 12.8-14.8 W4	20
3222 168	ÖTIKER ZERO CLAMP 13.9-16.1 W4	20
3222 175	ÖTIKER ZERO CLAMP 14.6-16.8 W4	15
3222 185	ÖTIKER ZERO CLAMP 15.6-17.8 W4	15
4681 200	RABITZ PLIERS DIN 9242 200MM	1

Article No.	Article Description	QTY
9000 3222	ASS.OETIKER-HOSE CLAMPS	1
9000R 3222	TRAY OETIKER-HOSE CLAMPS	1



Hose Fittings Assortment

- 155 pieces

Contents:

Article No.	Article Description	Quantity
3202 8 12	CLAMP SGL 8MM SW6 W2 8-12	10
3202 10 16	CLAMP SGL 8MM SW6 W2 10-16	10
3910 4	HOSE CONNECTOR GS 4	15
3910 6	HOSE CONNECTOR GS 6	15
3910 8	HOSE CONNECTOR GS 8	10
3911 64	HOSE CONNECTOR GRS 6-4	15
3912 4	HOSE CONNECTOR TS 4	15
3912 6	HOSE CONNECTOR TS 6	15
3912 8	HOSE CONNECTOR TS 8	10
3913 4	HOSE CONNECTOR YS 4	15
3913 6	HOSE CONNECTOR YS 6	15
3913 8	HOSE CONNECTOR YS 8	10

Article No.	Article Description	QTY
9000 391	ASS.HOSE FITTINGS	1
9000R 391	INTRAY HOSE FITTINGS	1



TORRO Hose Clamp Set

- With 450 hose clamps TORRO, clamping range 8 – 16 mm
- Robust workshop container with carrying handle, tool tray and 12 slide-in boxes
- Dimensions (W x H x D): 360 x 450 x 170 mm

Article No.	Article Description	QTY
3290 450	TORRO-HOSE CLAMPS SET	1

Contents:

- 155x hose clamps TORRO, clamping range 8 – 16 mm
- 60x hose clamps TORRO, clamping range 12 – 22 mm
- 100x hose clamps TORRO, clamping range 16 – 27 mm
- 50x hose clamps TORRO, clamping range 20 – 32 mm
- 50x hose clamps TORRO, clamping range 25 – 40 mm
- 15x hose clamps TORRO, clamping range 35 – 50 mm
- 20x hose clamps TORRO, clamping range 50 – 70 mm



TORRO Hose Clamp Holder

- For wall mounting
- Clearly laid out, space-saving arrangement
- Ø 8 – 12 to 50 – 70 = 115 pieces
- 1x Art. No. 3295 7: Flexible A-6 hexagonal screwdriver

Contents:

Article No.	Article Description	Quantity
3200 8 12	HOSE CL TOR 7.5MM SW6 W2 8-12	20
3200 10 16	HOSE CL TOR 7.5MM SW6 W2 10-16	20
3200 12 20	HOSE CL TOR 9MM SW7 W2 12-22	20
3200 16 25	HOSE CL TOR 9MM SW7 W2 16-27	10
3200 20 32	HOSE CL TOR 9MM SW7 W2 20-32	10
3200 25 40	HOSE CL TOR 9MM SW7 W2 25-40	10
3200 32 50	HOSE CL TOR 9MM SW7 W2 32-50	10
3200 40 60	HOSE CL TOR 9MM SW7 W2 40-60	10
3200 50 70	HOSE CL TOR 9MM SW7 W2 50-70	5
3290 100	HOSE CLAMP HOLDER - EMPTY	1
3295 7	A HEX SPEED WRENCH FLEX W. 7	1



Article No.	Article Description	QTY
3290 10	TORRO HOSE CLAMP HOLDER EQUIP.	1

Axle Boot Clamp Holder

- For wall mounting
- Clearly laid out, space-saving arrangement
- Ø 25 – 31 to 90 – 97 = 100 pieces
- 1x Art. No. 3102 4000: Clamping pliers for perforated strip clamps

Contents:

Article No.	Article Description	Quantity
3102 4000	CLAMP.PLIERS F.PERFORATED CLIP	1
3236 7 31	PERFORATED CLIP 7/25-31MM	10
3236 7 35	PERFORATED CLIP 7/29-35MM	20
3236 7 37	PERFORATED CLIP 7/31-37MM	20
3236 7 44	PERFORATED CLIP 7/36-44MM	10
3236 9 78	PERFORATED CLIP 9/70-78MM	10
3236 9 88	PERFORATED CLIP 9/80-88MM	20
3236 9 97	PERFORATED CLIP 9/90-97MM	10
3300 100	RUB. BOOTS CL. HOLD. W. HOOK EMPTY	1



Article No.	Article Description	QTY
3236 10	AXLE BOOT CLAMP HOLDER EQUIP.	1

Hose Clamp Holder ABA

- For wall mounting
- Clearly laid out, space-saving arrangement
- Ø 8 – 14 to 87 – 112 = 60 pieces
- 1x Art. No. 3295 7: Flexible A-6 hexagonal screwdriver

Contents:

Article No.	Article Description	Quantity
3223 8 14	HOSE CL.ABA 9MM SW7 W1 8-14	10
3223 15 24	HOSE CL.ABA 12.2MM SW7 W1 15-24	10
3223 22 32	HOSE CL.ABA 12.2MM SW7 W1 22-32	10
3223 32 44	HOSE CL.ABA 12.2MM SW7 W1 32-44	10
3223 38 50	HOSE CL.ABA 12.2MM SW7 W1 38-50	5
3223 50 65	HOSE CL.ABA 12.2MM SW7 W1 50-65	5
3223 68 85	HOSE CL.ABA 12.2MM SW7 W1 68-85	5
3223 87 112	HOSE C.ABA 12.2MM SW7 W1 87-112	5
3290 100	HOSE CLAMP HOLDER - EMPTY	1
3295 7	A HEX SPEED WRENCH FLEX W. 7	1



Article No.	Article Description	QTY
3223 1	ABA-HOSE CLAMP HOLDER ASSEMBL.	1

Sealing Rings for Oil Drain Plugs, Assortment

• 12 x 18 – 22 x 27 = 600 pieces

Contents:

Article No.	Article Description	Quantity
2600 12 18	SEAL.RING 7603 A CO 12X18X1.5	50
2600 14 20	SEAL.RING 7603 A CO 14X20X1.5	100
2600 16 22	SEAL.RING 7603 A CO 16X22X1.5	50
2600 18 24	SEAL.RING 7603 A CO 18X24X1.5	50
2610 14 20	SEAL.RING 7603 C CO 14X20X2	25
2610 16 22	SEAL.RING 7603 C CO 16X22X2	25
2620 12 18	SEAL.RING 7603 A ALU 12X18X1.5	50
2620 14 20	SEAL.RING 7603 A ALU 14X20X1.5	50
2620 16 22	SEAL.RING 7603 A ALU 16X22X1.5	50
2620 22 27	SEAL.RING 7603 A ALU 22X27X1.5	50
2665 12 20	FORD SEAL.RING 12X20	50
2665 145 22	FORD SEAL.RING 14.5X22 WHITE	50



Article No.	Article Description	QTY
9000 26	ASS.OIL DRAIN SEALING RINGS	1
9000R 26	TRAY OIL DRAIN SEALING RINGS	1

Special-Oil Sealing Rings, Assortment

• 14 x 18 – 28 x 34 = 775 pieces

Contents:

Article No.	Article Description	Quantity
2600 14 20	SEAL.RING 7603 A CO 14X20X1.5	100
2600 27 32	SEAL.RING 7603 A CO 27X32X2	50
2610 16 22	SEAL.RING 7603 C CO 16X22X2	100
2620 14 18	SEAL.RING 7603 A ALU 14X18X1.5	100
2620 14 20	SEAL.RING 7603 A ALU 14X20X1.5	100
2620 18 22	SEAL.RING 7603 A ALU 18X22X1.5	100
2620 28 34	SEAL.RING 7603 A ALU 28X34X2	50
2640 16	SCR. SEAL. WASH. 16.7X24X1.5 M	25
2641 14	FD-SEA.RING ST/RUB.14.7X24X1.5	50
2650 2 18	O-RING NBR 2 X18	25
2665 145 22	FORD SEAL.RING 14.5X22 WHITE	50
2666 12 215	TOY.SEA.RIN.12X21.5 9043012011	25



Article No.	Article Description	QTY
9000 260	ASS.SPECIAL OIL SEAL.RINGS	1
9000R 260	TRAY SPEC.OIL SEAL.WASH.ASS.	1

Sealing Rings 7603 A, Copper, Assortment

• 6 x 10 – 32 x 38 = 1,195 pieces

Contents:

Article No.	Article Description	Quantity
2600 6 10	SEAL.RING 7603 A CO 6X10X1	100
2600 6 12	SEAL.RING 7603 A CO 6X12X1	100
2600 8 12	SEAL.RING 7603 A CO 8X12X1	100
2600 8 14	SEAL.RING 7603 A CO 8X14X1	100
2600 10 14	SEAL.RING 7603 A CO 10X14X1	100
2600 10 16	SEAL.RING 7603 A CO 10X16X1	100
2600 12 16	SEAL.RING 7603 A CO 12X16X1.5	100
2600 12 18	SEAL.RING 7603 A CO 12X18X1.5	100
2600 14 18	SEAL.RING 7603 A CO 14X18X1.5	100
2600 14 20	SEAL.RING 7603 A CO 14X20X1.5	100
2600 16 20	SEAL.RING 7603 A CO 16X20X1.5	50
2600 16 22	SEAL.RING 7603 A CO 16X22X1.5	25
2600 18 24	SEAL.RING 7603 A CO 18X24X1.5	25
2600 20 26	SEAL.RING 7603 A CO 20X26X1.5	25
2600 22 27	SEAL.RING 7603 A CO 22X27X1.5	25
2600 26 32	SEAL.RING 7603 A CO 26X32X2	25
2600 30 36	SEAL.RING 7603 A CO 30X36X2	10
2600 32 38	SEAL.RING 7603 A CO 32X38X2	10



Article No.	Article Description	QTY
9000 2600	ASS.CU SEALING RINGS DIN7603	1
9000R 2600	TRAY SEALING RINGS DIN7603 CU	1

Sealing Rings DIN7603 C, Copper Filled, Assortment

• 6 × 10 – 24 × 32 = 535 pieces

Contents:

Article No.	Article Description	Quantity
2610 6 10	SEAL.RING 7603 C CO 6X10X1.5	50
2610 6 12	SEAL.RING 7603 C CO 6X12X1.5	50
2610 8 12	SEAL.RING 7603 C CO 8X12X1.5	50
2610 8 14	SEAL.RING 7603 C CO 8X14X1.5	50
2610 10 16	SEAL.RING 7603 C CO 10X16X1.5	50
2610 12 18	SEAL.RING 7603 C CO 12X18X2	50
2610 14 18	SEAL.RING 7603 C CO 14X18X2	50
2610 14 20	SEAL.RING 7603 C CO 14X20X2	50
2610 16 22	SEAL.RING 7603 C CO 16X22X2	50
2610 18 24	SEAL.RING 7603 C CO 18X24X2	50
2610 22 27	SEAL.RING 7603 C CO 22X27X2	25
2610 24 32	SEAL.RING 7603 C CO 24X32X2.5	10

Article No.	Article Description	QTY
9000 2610	ASS.SEAL.RINGS 7603C CU-FILL.	1
9000R 2610	TRAY SEAL.RINGS7603C CU-FILL.	1



Sealing Rings DIN 7603 A, Aluminium, Assortment

• 6 × 10 – 26 × 34 = 1,085 pieces

Contents:

Article No.	Article Description	Quantity
2620 6 10	SEAL.RING 7603 A ALU 6X10X1	100
2620 6 12	SEAL.RING 7603 A ALU 6X12X1	100
2620 8 12	SEAL.RING 7603 A ALU 8X12X1	100
2620 8 14	SEAL.RING 7603 A ALU 8X14X1	100
2620 10 14	SEAL.RING 7603 A ALU 10X14X1	100
2620 10 16	SEAL.RING 7603 A ALU 10X16X1	100
2620 12 16	SEAL.RING 7603 A ALU 12X16X1.5	50
2620 12 18	SEAL.RING 7603 A ALU 12X18X1.5	50
2620 14 18	SEAL.RING 7603 A ALU 14X18X1.5	50
2620 14 20	SEAL.RING 7603 A ALU 14X20X1.5	50
2620 16 22	SEAL.RING 7603 A ALU 16X22X1.5	50
2620 18 24	SEAL.RING 7603 A ALU 18X24X1.5	50
2620 20 26	SEAL.RING 7603 A ALU 20X26X1.5	50
2620 22 27	SEAL.RING 7603 A ALU 22X27X1.5	50
2620 22 29	SEAL.RING 7603 A ALU 22X29X1.5	25
2620 24 29	SEAL.RING 7603 A ALU 24X29X2	25
2620 26 32	SEAL.RING 7603 A ALU 26X32X2	25
2620 26 34	SEAL.RING 7603 A ALU 26X34X2	10

Article No.	Article Description	QTY
9000 2620	ASS.ALU SEALING RINGS DIN7603	1
9000R 2620	TRAY SEALING RINGS DIN7603 ALU	1



Sealing Rings DIN 7603 A, Vulcanized Fibre, Ass.

• 5 × 9 – 18 × 24 = 725 pieces

Contents:

Article No.	Article Description	Quantity
2630 5 9	SEALING RING 7603 A VF 5X 9X1	100
2630 6 10	SEALING RING 7603 A VF 6X10X1	100
2630 6 12	SEALING RING 7603 A VF 6X12X1	100
2630 8 12	SEALING RING 7603 A VF 8X12X1	100
2630 8 14	SEALING RING 7603 A VF 8X14X1	100
2630 10 16	SEALING RING 7603 A VF 10X16X1	50
2630 12 16	SEALING RING 7603 A VF 12X16X1	50
2630 12 20	SEALING RING 7603 A VF 12X20X1	25
2630 14 18	SEALING RING 7603 A VF 14X18X1	25
2630 14 20	SEALING RING 7603 A VF 14X20X1	25
2630 16 22	SEALING RING 7603 A VF 16X22X1	25
2630 18 24	SEALING RING 7603 A VF 18X24X1	25

Article No.	Article Description	QTY
9000 2630	ASS.SEALING RINGS 7603A VF	1
9000R 2630	TRAY SEALING RINGS 7603A VF	1



O-Rings, Metric in Assortment

• 1.5x3–3x30 = 360 pieces

Contents:

Article No.	Article Description	Quantity
2650 15 3	O-RING NBR 1.5X 3	25
2650 15 5	O-RING NBR 1.5X 5	25
2650 15 7	O-RING NBR 1.5X 7	25
2650 2 6	O-RING NBR 2 X6	25
2650 2 8	O-RING NBR 2 X8	25
2650 2 10	O-RING NBR 2 X10	25
2650 25 10	O-RING NBR 2.5X10	20
2650 25 12	O-RING NBR 2.5X12	20
2650 25 15	O-RING NBR 2.5X15	20
2650 3 14	O-RING NBR 3 X14	20
2650 3 16	O-RING NBR 3 X16	20
2650 3 18	O-RING NBR 3 X18	20
2650 3 20	O-RING NBR 3 X20	15
2650 3 22	O-RING NBR 3 X22	15
2650 3 24	O-RING NBR 3 X24	15
2650 3 26	O-RING NBR 3 X26	15
2650 3 28	O-RING NBR 3 X28	15
2650 3 30	O-RING NBR 3 X30	15



Article No.	Article Description	QTY
9000 2650	ASSORTMENT O-RING METRIC	1
9000R 2650	TRAY O-RING METRIC	1

O-Rings, Inch Sizes, 450 pcs. Assortment

• 1.78 x 2.9 – 2.62 x 21.89 = 450 pieces

Contents:

Article No.	Article Description	Quantity
2651 178 29	O-RING NBR 1.78X 2.9	30
2651 178 369	O-RING NBR 1.78X 3.69	30
2651 178 448	O-RING NBR 1.78X 4.48	30
2651 178 528	O-RING NBR 1.78X 5.28	30
2651 178 607	O-RING NBR 1.78X 6.07	30
2651 178 766	O-RING NBR 1.78X 7.66	30
2651 178 925	O-RING NBR 1.78X 9.25	25
2651 178 1082	O-RING NBR 1.78X10.82	25
2651 178 1242	O-RING NBR 1.78X12.42	25
2651 262 919	O-RING NBR 2.62X 9.19	25
2651 262 1078	O-RING NBR 2.62X10.78	25
2651 262 1237	O-RING NBR 2.62X12.37	25
2651 262 1395	O-RING NBR 2.62X13.95	20
2651 262 1554	O-RING NBR 2.62X15.54	20
2651 262 1713	O-RING NBR 2.62X17.13	20
2651 262 1872	O-RING NBR 2.62X18.72	20
2651 262 2029	O-RING NBR 2.62X20.29	20
2651 262 2189	O-RING NBR 2.62X21.89	20



Article No.	Article Description	QTY
9000 2651	ASSORTMENT O-RING INCH	1
9000R 2651	TRAY O-RINGS INCH	1

O-Rings, Inch Sizes, 270 pcs. Assortment

• $2.62 \times 23.47 - 3.53 \times 36.10 = 270$ pieces

Contents:

Article No.	Article Description	Quantity
2651 262 2347	O-RING NBR 2.62X23.47	20
2651 262 2507	O-RING NBR 2.62X25.07	20
2651 262 2665	O-RING NBR 2.62X26.65	20
2651 262 2824	O-RING NBR 2.62X28.24	20
2651 262 3142	O-RING NBR 2.62X31.42	20
2651 262 33	O-RING NBR 2.62X33	20
2651 353 1864	O-RING NBR 3.53X18.64	15
2651 353 2022	O-RING NBR 3.53X20.22	15
2651 353 2182	O-RING NBR 3.53X21.82	15
2651 353 234	O-RING NBR 3.53X23.4	15
2651 353 2499	O-RING NBR 3.53X24.99	15
2651 353 2658	O-RING NBR 3.53X26.58	15
2651 353 2817	O-RING NBR 3.53X28.17	10
2651 353 2975	O-RING NBR 3.53X29.75	10
2651 353 3134	O-RING NBR 3.53X31.34	10
2651 353 3292	O-RING NBR 3.53X32.92	10
2651 353 3452	O-RING NBR 3.53X34.52	10
2651 353 361	O-RING NBR 3.53X36.1	10



Article No.	Article Description	QTY
9000 2651 1	ASSORTMENT O-RINGS INCH	1
9000R 2651 1	TRAY O-RINGS INCH	1

Screws – Sealing Rings, Assortment

- Steel disc with vulcanised rubber lip
- M5 – M24 = 135 pieces

Contents:

Article No.	Article Description	Quantity
2640 5	SCR. SEAL. WASH. 5.7X10X1 M 5	20
2640 6	SCR. SEAL. WASH. 6.7X10X1 M 6	20
2640 7	SCR. SEAL. WASH. 7.1X12X1 M 7	20
2640 8	SCR. SEAL. WASH. 8.7X13X1 M 8	10
2640 10	SCR. SEAL. WASH. 10.7X16X1.5 M	10
2640 12	SCR. SEAL. WASH. 12.7X18X1.5 M	10
2640 14	SCR. SEAL. WASH. 14.7X22X1.5 M	10
2640 16	SCR. SEAL. WASH. 16.7X24X1.5 M	10
2640 18	OPEL SE.R.ST/RU. 18.7X26X1.5M18	10
2640 20	SCR. SEAL. WASH. 20.7X28X1.5 M	5
2640 22	SCR. SEAL. WASH. 22.7X30X2 M22	5
2640 24	SCR. SEAL. WASH. 24.7X32X2 M24	5

Article No.	Article Description	QTY
9000 2640	ASS.SEAL.WASH.W.RUBBER INSERT	1
9000R 2640	INTRAY SEAL.WASH.W.RUB.INSERT	1



Multigrade-Blind Rivets, Assortment

- 3.2 × 8 – 4.8 × 16 = 529 pieces
- 1 × Art. No. 2722 1: hand rivet gun MFX 150 B

Contents:

Article No.	Article Description	Quantity
2722 1	HAND RIVET GUN MFX150B	1
2730 32 8	FRK-MB-BLINDN. AL/ST 3,2X 8	50
2730 32 95	BLIND RIVET TRUSS-HEAD 3.2X9.5	50
2730 32 111	BLIND RIVET TRUSS-HD 3.2X11.1	50
2730 4 95	BLIND RIVET TRUSS HEAD 4X9.5	50
2730 4 127	BLIND RIVET TRUSS-HEAD 4X12	50
2730 4 16	BLIND RIVET TRUSS-HEAD 4X16	50
2730 48 103	BLIND RIVET TRUSS-HEAD 4.8X10	50
2730 48 17	BLIND RIVET TRUSS-HEAD 4.8X17	50
2730 48 248	BLIND RIVET TRUSS-HEAD4.8X24.8	50
2731 4 11	BLIND RIVET COUNTERSUNK 4X11.1	25
2731 48 10	BLIND RIVET COUNTERSUNK 4.8X10	25
2731 48 16	BLIND RIVET COUNTERSUNK 4.8X16	25
5500 33	TWIST DRILL 338 ROLL F. 3.3	1
5500 42	TWIST DRILL 338 ROLL F. 4.2	1
5500 50	TWIST DRILL 338 ROLL F. 5.0	1

Article No.	Article Description	QTY
9000 273	ASS.MULTIGRADE RIVET ALU	1
9000R 273	INTRAY MULTIGRADE RIVET ALU	1



Blind Rivet Aluminium Black, Assortment

- 3 × 8 – 5 × 16/14 = 379 pieces
- 1 × Art. No. 2722 1: hand rivet gun MFX 150 B

Contents:

Article No.	Article Description	Quantity
2707 4 10	BLIND RIVET AL BLACK/ST 4X10	50
2707 4 12	BLIND RIVET AL BLACK/ST 4X12	25
2707 4 16	BLIND RIVET AL BLACK/ST 4X16	25
2708 5 12	BLIND RIVET AL BLACK/ST 4.8X12	25
2708 5 14	BLIND RIVET AL BLACK/ST 4.8X14	25
2708 5 16	BLIND RIVET AL BLACK/ST 4.8X16	25
2717 3 8	BLIND RIVET TRUSS-HEAD 3X8	50
2717 3 10	BLIND RIVET TRUSS-HEAD 3X10	50
2717 4 8	BLIND RIVET TRUSS-HEAD 4X8	25
2717 4 12	BLIND RIVET TRUSS-HEAD 4X12	25
2717 5 12	BLIND RIVET TRUSS-HEAD 4.8X12	25
2717 5 16	BLIND RIVET TRUSS-HEAD 4.8X16	25
2722 1	HAND RIVET GUN MFX150B	1
5500 31	TWIST DRILL 338 ROLL F. 3.1	1
5500 41	TWIST DRILL 338 ROLL F. 4.1	1
5500 51	TWIST DRILL 338 ROLL F. 5.1	1

Article No.	Article Description	QTY
9000 2717	ASS.BLIND RIVET ALU BLACK	1
9000R 2717	INTRAY BLIND RIVET ALU BLACK	1



Aluminium Blind Rivet Nut Assortment

- M3 – M6 = 300 pieces
- Blind rivet nut pliers MFX 306 (Art No. 2748 10) with accessories:
 - Mandrels M3 - M6 for MFX 306 pliers (Art No. 2748 13 ff.)
 - Nosepieces M3 - M6 for MFX 306 pliers (Art No. 2748 23 ff.)

Contents:

Article No.	Article Description	Quantity
2740 3 25	FH-BLIND RIV.NUT AL M 3-2.5	25
2740 3 35	FH-BLIND RIV.NUT AL M 3-3.5	25
2740 4 3	FH-BLIND RIV.NUT AL M 4-3	25
2740 4 45	FH-BLIND RIV.NUT AL M 4-4.5	25
2740 5 3	FH-BLIND RIV.NUT AL M 5-3	25
2740 5 55	FH-BLIND RIV.NUT AL M 5-5.5	50
2740 5 8	FH-BLIND RIV.NUT AL M 5-8	25
2740 6 3	FH-BLIND RIV.NUT AL M 6-2.5	25
2740 6 55	FH-BLIND RIV.NUT AL M 6-5.5	50
2740 6 8	FH-BLIND RIV.NUT AL M 6-8	25
2748 1 0	BLIND RIV.NUT PL.SET MFX 306S	1

Article No.	Article Description	QTY
9000 2740	ASS.BLIND RIVET NUTS ALU	1
9000R 2740	INTRAY BLIND RIVET NUTS ALU	1



Steel Blind Rivet Nut Assortment

- Flat head: M4 – M6 = 150 pieces
- Mini countersunk head: M4 – M6 = 75 pieces
- Mini countersunk head with knurl: M4 – M6 = 75 pieces
- Blind rivet nut pliers MFX 306 (Art No. 2748 10) with accessories:
 - Mandrels M3 – M6 (Art. No. 2748 1 4 ff.)
 - Nosepieces M3 – M6 (Art. No. 2748 2 4 ff.)

Contents:

Article No.	Article Description	Quantity
2742 4 3	FH-BLIN.RIV.NUT ST RIB.M 4-3	50
2742 5 3	FH-BLIN.RIV.NUT ST RIB.M 5-3	25
2742 5 55	FH-BLIN.RIV.NUT ST RIB.M 5-5.5	25
2742 6 3	FH-BLIN.RIV.NUT ST RIB.M 6-3	50
2744 4	MINI CSK RIVET NUT STEEL M4	25
2744 5	MINI CSK RIVET NUT STEEL M5	25
2744 6	MINI CSK RIVET NUT STEEL M6	25
2745 4	MINI CSK KN.BL.R.NUT ST.M4-2.5	25
2745 5	MINI CSK KN.BL.R.NUT ST.M 5-3	25
2745 6	MINI CSK KN.BL.R.NUT ST.M 6-3	25
2748 1 0	BLIND RIV.NUT PL.SET MFX 306S	1

Article No.	Article Description	QTY
9000 274	ASS.BLIND RIV.NUTS COMBI FLAT	1
9000R 274	INTRAY BLIND RIVET NUTS COMBI	1



Cup Washers, Black / Nickel Plated, Assortment

- 400 pieces

Contents:

Article No.	Article Description	Quantity
2390 4115	CUP WASHER BLACK 4115	100
2390 4125	CUP WASHER BLACK 4125	50
2390 4136	CUP WASHER BLACK 4136	50
2391 4115	CUP WASHER NICKEL 4115	100
2391 4125	CUP WASHER NICKEL 4125	50
2391 4136	CUP WASHER NICKEL 4136	50

Article No.	Article Description	QTY
9000 239	ASSORTMENT CUP WASHERS	1
9000R 239	TRAY CUP WASHERS	1



Number Plate Screws and Caps in Assortment

• 4.8 × 16 – 5.5 × 38 = 805 pieces

Contents:

Article No.	Article Description	Quantity
1891 55 19	NPS 7981 ZN 5.5X19 WITH WASHER	25
1893 5	NPS CAPS WHITE 5	100
1893 6	NPS CAPS WHITE 6	100
1894 5	NPS CAPS BLACK 5	100
1894 6	NPS CAPS BLACK 6	100
1895 1	DISTANCE WASHER WHITE M5/M6	100
1899 5 20	NPS COUPL. GA 5X20 WITHOUT CAP	40
1899 6 20	NPS COUPL. GA 6X20 WITHOUT CAP	40
1899 48 16	NPS SIM.TO 7981 ZN 4.8X16	50
1899 48 19	NPS SIM.TO 7981 ZN 4.8X19	50
1899 48 22	NPS SIM.TO 7981 ZN 4.8X22	50
1899 48 25	NSS SIM.TO 7981 ZN 4.8X25	50

Article No.	Article Description	QTY
9000 18	ASSORTMENT NUMBERPLATE SCREWS	1
9000R 18	NUMBERPLATE SCREWS IN TRAY	1



Large Diameter Washers, Zinc-coated, Assortment

• For screws M5 × 20 – M10 × 40 = 900 pieces

Contents:

Article No.	Article Description	Quantity
2331 5 20	PANEL REP WASHER GA 5X20	100
2331 5 25	PANEL REP WASHER GA 5X25	100
2331 5 30	PANEL REP WASHER GA 5X30	50
2331 6 15	PANEL REP WASHER GA 6X15	100
2331 6 20	PANEL REP WASHER GA 6X20	100
2331 6 25	PANEL REP WASHER GA 6X25	100
2331 6 30	PANEL REP WASHER GA 6X30	50
2331 8 25	PANEL REP WASHER GA 8X25	100
2331 8 30	PANEL REP WASHER GA 8X30	50
2331 8 40	PANEL REP WASHER GA 8X40	50
2331 10 30	PANEL REP WASHER GA 10X30	50
2331 10 40	PANEL REP WASHER GA 10X40	50

Article No.	Article Description	QTY
9000 2331	ASS.LG DIA WASHERS GA	1
9000R 2331	TRAY LG DIA WASHERS GA	1



Abrasive Pines, Assortment

• 10 × 30 – 20 × 32 = 19 pieces

Contents:

Article No.	Article Description	Quantity
5970 1 10	GRINDING PEN.ZY FORM 1 D10MM	3
5970 1 13	GRINDING PEN.ZY FORM 1 D13MM	3
5970 1 20	GRINDING PEN.ZY FORM 1 D20MM	3
5970 2 16	GRINDING PEN.ZY FORM 2 D16MM	2
5970 2 20	GRINDING PEN.ZY FORM 2 D20MM	2
5970 2 32	GRINDING PEN.ZY FORM 2 D32MM	2
5970 3 20	GRINDING PEN.WK FORM 3 D20MM	1
5970 4 13	GRINDING PEN.SP FORM 4 D13MM	1
5970 5 16	GRINDING PEN.KU FORM 5 D16MM	1
5970 6 20	GRINDING PEN.WR FORM 6 D20MM	1

Article No.	Article Description	QTY
9000 5970	ASS.ABRASIVE PINES	1
9000R 5970	INTRAY ABRASIVE PINES	1



Abrasive Belts, Assortment

• P 50, P 80, P 150 = 48 pieces

Contents:

Article No.	Article Description	Quantity
5960 15 50	ABRASIVE BAND D15MM B30MM P50	5
5960 15 80	ABRASIVE BAND D15MM B30MM P80	5
5960 15 150	ABRASIVE BAND D15MM B30MM P150	5
5960 22 50	ABRASIVE BAND D22MM B20MM P50	5
5960 22 80	ABRASIVE BAND D22MM B20MM P80	5
5960 22 150	ABRASIVE BAND D22MM B20MM P150	5
5960 30 50	ABRASIVE BAND D30MM B30MM P50	5
5960 30 80	ABRASIVE BAND D30MM B30MM P80	5
5960 30 150	ABRASIVE BAND D30MM B30MM P150	5
5961 15	ABRASIVE BAND ARBOR D15MM	1
5961 22	ABRASIVE BAND ARBOR D22MM	1
5961 30	ABRASIVE BAND ARBOR D30MM	1

Article No.	Article Description	QTY
9000 5960	ASSORTMENT ABRASIVE BELTS	1
9000R 5960	INTRAY ABRASIVE BELTS	1



Abrasive Caps, Assortment

• P 80, P 150, P 320 = 48 pieces

Contents:

Article No.	Article Description	Quantity
5963 16 80	GRINDING CAPS CYL D16MM P 80	5
5963 16 150	GRINDING CAPS CYL D16MM P150	5
5963 16 320	GRINDING CAPS CYL D16MM P320	5
5964 16	GRIND.CAP ARBOR CYLINDRI.D16MM	1
5965 16 80	GRINDING CAPS DOMED D16MM P80	5
5965 16 150	GRINDING CAPS DOMED D16MM P150	5
5965 16 320	GRINDING CAPS DOMED D16MM P320	5
5966 16	GRINDING CAP ARBOR DOMED D16MM	1
5967 16 80	GRIND.CAPS CONICAL D16MM P80	5
5967 16 150	GRIND.CAPS CONICAL D16MM P150	5
5967 16 320	GRIND.CAPS CONICAL D16MM P320	5
5968 16	GRIND.CAP ARBOR CONICAL D16MM	1

Article No.	Article Description	QTY
9000 596	ASSORTMENT ABRASIVE CAPS	1
9000R 596	INTRAY ABRASIVE CAPS	1



Retaining Rings DIN 6799, Assortment

• Ø 2.3 – Ø 19.0 = 920 pieces

Contents:

Article No.	Article Description	Quantity
2530 23	RET WASHER F. SHAFTS 6799 2.3	100
2530 32	RET WASHER F. SHAFTS 6799 3.2	100
2530 4	RET WASHER F. SHAFTS 6799 4	100
2530 5	RET WASHER F. SHAFTS 6799 5	100
2530 6	RET WASHER F. SHAFTS 6799 6	100
2530 7	RET WASHER F. SHAFTS 6799 7	100
2530 8	RET WASHER F. SHAFTS 6799 8	100
2530 9	RET WASHER F. SHAFTS 6799 9	50
2530 10	RET WASHER F. SHAFTS 6799 10	100
2530 12	RET WASHER F. SHAFTS 6799 12	50
2530 15	RET WASHER F. SHAFTS 6799 15	10
2530 19	RET WASHER F. SHAFTS 6799 19	10

Article No.	Article Description	QTY
9000 2530	ASSORTM.RETAINING RINGS 6799	1
9000R 2530	TRAY RETAINING RINGS 6799	1



Retaining Rings for Shafts, DIN 471, Assortment

• Ø 8 – 40 = 715 pieces

Contents:

Article No.	Article Description	Quantity
2541 8	RET RING F. SHAFT 471 A 8	100
2541 10	RET RING F. SHAFT 471 A 10	100
2541 12	RET RING F. SHAFT 471 A 12	100
2541 14	RET RING F. SHAFT 471 A 14	50
2541 15	RET RING F. SHAFT 471 A 15	50
2541 16	RET RING F. SHAFT 471 A 16	50
2541 17	RET RING F. SHAFT 471 A 17	25
2541 18	RET RING F. SHAFT 471 A 18	25
2541 20	RET RING F. SHAFT 471 A 20	25
2541 22	RET RING F. SHAFT 471 A 22	25
2541 24	RET RING F. SHAFT 471 A 24	25
2541 25	RET RING F. SHAFT 471 A 25	25
2541 26	RET RING F. SHAFT 471 A 26	25
2541 28	RET RING F. SHAFT 471 A 28	20
2541 30	RET RING F. SHAFT 471 A 30	20
2541 32	RET RING F. SHAFT 471 A 32	20
2541 35	RET RING F. SHAFT 471 A 35	20
2541 40	RET RING F. SHAFT 471 A 40	10

Article No.	Article Description	QTY
9000 2541	ASSORTMENT LOCK RINGS DIN 471A	1
9000R 2541	TRAY LOCK RINGS DIN 471 A	1



Retaining Rings for Bores, DIN 472, Assortment

• Ø 15 – 42 = 480 pieces

Contents:

Article No.	Article Description	Quantity
2542 15	RET RING F. SHAFT 472 I 15	50
2542 16	RET RING F. SHAFT 472 I 16	50
2542 18	RET RING F. SHAFT 472 I 18	50
2542 20	RET RING F. SHAFT 472 I 20	50
2542 22	RET RING F. SHAFT 472 I 22	25
2542 23	RET RING F. SHAFT 472 I 23	25
2542 24	RET RING F. SHAFT 472 I 24	25
2542 25	RET RING F. SHAFT 472 I 25	25
2542 26	RET RING F. SHAFT 472 I 26	25
2542 28	RET RING F. SHAFT 472 I 28	25
2542 30	RET RING F. SHAFT 472 I 30	25
2542 32	RET RING F. SHAFT 472 I 32	25
2542 34	RET RING F. SHAFT 472 I 34	20
2542 35	RET RING F. SHAFT 472 I 35	20
2542 36	RET RING F. SHAFT 472 I 36	10
2542 38	RET RING F. SHAFT 472 I 38	10
2542 40	RET RING F. SHAFT 472 I 40	10
2542 42	RET RING F. SHAFT 472 I 42	10



Article No.	Article Description	QTY
9000 2542	ASSORTMENT LOCK RINGS 472 I	1
9000R 2542	TRAY LOCK RINGS 472 I	1

Compression Springs DIN 2095, GA, Assortment

• 8 × 42 – 15 × 65 = 250 pieces

Contents:

Article No.	Article Description	Quantity
2922 8 42	COMPRESSION SPRING GA 0.8 8X42	40
2922 10 32	COMPRESSION SPRING GA 1 10X32	20
2922 10 40	COMPRESSION SPRING GA 1 10X40	25
2922 10 45	COMPR. SPRING GA 1.5 10X45	25
2922 12 35	COMPRESSION SPRING GA 1 12X35	30
2922 12 55	COMPR. SPRING GA 1.5 12X55	15
2922 12 60	COMPRESSION SPRING GA 1 12X60	20
2922 12 35 15	COMPR. SPRING GA 1.5 12X35	20
2922 15 28	COMPR. SPRING GA 1.5 15X28	20
2922 15 45	COMPR. SPRING GA 1.5 15X45	15
2922 15 55	COMPR. SPRING GA 1.5 15X55	10
2922 15 65	COMPR. SPRING GA 1.5 15X65	10

Article No.	Article Description	QTY
9000 2922	ASS.COMPRESSION SPRINGS 2095	1
9000R 2922	TRAY COMPRESSION SPRINGS 2095	1



Tension Springs DIN 2097, GA, Assortment

• 5 × 50 – 12,5 × 110 = 185 pieces

Contents:

Article No.	Article Description	Quantity
2920 5 50	EXTENSION SPRING GA 0.6 5X50	15
2920 6 25	EXTENSION SPRING GA 0.6 6X25	20
2920 7 25	EXTENSION SPRING GA 1.3 7X25	15
2920 7 55	EXTENSION SPRING GA 0.6 7X55	10
2920 7 90	EXTENSION SPRING GA 1 7X90	10
2920 8 55	EXTENSION SPRING GA 1 8X55	10
2920 8 70	EXTENSION SPRING GA 1 8X70	10
2920 9 45	EXTENSION SPRING GA 1 9X45	5
2920 9 75	EXTENSION SPRING GA 1 9X75	5
2920 9 100	EXTENSION SPRING GA 1 9X100	10
2920 10 60	EXTENSION SPRING GA 1 10X60	15
2920 10 105	EXTENSION SPRING GA 1 10X105	5
2920 11 55	EXTENSION SPRING GA 1 11X55	5
2920 11 55 13	EXTENSION SPRING GA 1.3 11X55	10
2920 11 70	EXTENSION SPRING GA 1 11X70	10
2920 11 130	EXTENSION SPRING GA 1 11X130	5
2920 12 65	EXTENSION SPRING GA 1.5 12X65	5
2920 12 85	EXTENSION SPRING GA 1 12X85	5
2920 125 75	EXTENS. SPRING GA 1.5 12.5X75	10
2920 125 110	EXTENS. SPRING GA 1.5 12.5X110	5

Article No.	Article Description	QTY
9000 2920	ASS.TENSION SPRINGS 2097	1
9000R 2920	TRAY TENSION SPRINGS 2097	1



Cotter Pins DIN 94, GA, Assortment

• 1 × 20 – 6 × 63 = 1,325 pieces

Contents:

Article No.	Article Description	Quantity
2801 1 20	SPLIT PIN 94 GA 1X20	200
2801 16 32	SPLIT PIN 94 GA 1.6X32	200
2801 2 32	SPLIT PIN 94 GA 2X32	200
2801 25 32	SPLIT PIN 94 GA 2.5X32	100
2801 25 40	SPLIT PIN 94 GA 2.5X40	100
2801 32 32	SPLIT PIN 94 GA 3.2X32	100
2801 32 50	SPLIT PIN 94 GA 3.2X50	100
2801 35 40	SPLIT PIN 94 GA 3.5X40	100
2801 4 40	SPLIT PIN 94 GA 4X40	100
2801 4 63	SPLIT PIN 94 GA 4X63	50
2801 5 50	SPLIT PIN 94 GA 5X50	50
2801 63 63	SPLIT PIN 94 GA 6.3X63	25

Article No.	Article Description	QTY
9000 2801	ASSORTMENT COTTER PINS 94 GA	1
9000R 2801	TRAY COTTER PINS 94 GALVANIZED	1



Shims, Ø 10–20 mm, Plain Steel, Assortment

- 360 pieces
- Plain steel

Contents:

Article No.	Article Description	Quantity
2340 10 16 03	POSITION. WASHER 988 10X16X0.3	20
2340 10 16 05	POSITION. WASHER 988 10X16X0.5	20
2340 10 16 1	POSITION. WASHER 988 10X16X1	20
2340 12 18 03	POSITION. WASHER 988 12X18X0.3	20
2340 12 18 05	POSITION. WASHER 988 12X18X0.5	20
2340 12 18 1	POSITION. WASHER 988 12X18X1	20
2340 14 20 03	POSITION. WASHER 988 14X20X0.3	20
2340 14 20 05	POSITION. WASHER 988 14X20X0.5	20
2340 14 20 1	POSITION. WASHER 988 14X20X1	20
2340 16 22 03	POSITION. WASHER 988 16X22X0.3	20
2340 16 22 05	POSITION. WASHER 988 16X22X0.5	20
2340 16 22 1	POSITION. WASHER 988 16X22X1	20
2340 18 25 03	POSITION. WASHER 988 18X25X0.3	20
2340 18 25 05	POSITION. WASHER 988 18X25X0.5	20
2340 18 25 1	POSITION. WASHER 988 18X25X1	20
2340 20 28 03	POSITION. WASHER 988 20X28X0.3	20
2340 20 28 05	POSITION. WASHER 988 20X28X0.5	20
2340 20 28 1	POSITION. WASHER 988 20X28X1	20



Article No.	Article Description	QTY
9000 2340	ASS.SHIMS 10-20MM	1
9000R 2340	TRAY SHIMS 10-20MM	1

Shims, Ø 22–32 mm, Plain Steel, Assortment

- 270 pieces
- Plain steel

Contents:

Article No.	Article Description	Quantity
2340 22 32 03	POSITION. WASHER 988 22X32X0.3	15
2340 22 32 05	POSITION. WASHER 988 22X32X0.5	15
2340 22 32 1	POSITION. WASHER 988 22X32X1	15
2340 25 35 03	POSITION. WASHER 988 25X35X0.3	15
2340 25 35 05	POSITION. WASHER 988 25X35X0.5	15
2340 25 35 1	POSITION. WASHER 988 25X35X1	15
2340 26 37 03	POSITION. WASHER 988 26X37X0.3	15
2340 26 37 05	POSITION. WASHER 988 26X37X0.5	15
2340 26 37 1	POSITION. WASHER 988 26X37X1	15
2340 28 40 03	POSITION. WASHER 988 28X40X0.3	15
2340 28 40 05	POSITION. WASHER 988 28X40X0.5	15
2340 28 40 1	POSITION. WASHER 988 28X40X1	15
2340 30 42 03	POSITION. WASHER 988 30X42X0.3	15
2340 30 42 05	POSITION. WASHER 988 30X42X0.5	15
2340 30 42 1	POSITION. WASHER 988 30X42X1	15
2340 32 45 03	POSITION. WASHER 988 32X45X0.3	15
2340 32 45 05	POSITION. WASHER 988 32X45X0.5	15
2340 32 45 1	POSITION. WASHER 988 32X45X1	15



Article No.	Article Description	QTY
9000 2340 1	ASS.SHIMS 22-32MM	1
9000R 2340 1	TRAY SHIMS 22-32MM	1

Shims, Ø 34–40 mm, Plain Steel, Assortment

- 180 pieces
- Plain steel

Contents:

Article No.	Article Description	Quantity
2340 35 45 03	POSITION. WASHER 988 35X45X0.3	15
2340 35 45 05	POSITION. WASHER 988 35X45X0.5	15
2340 35 45 1	POSITION. WASHER 988 35X45X1	15
2340 37 47 03	POSITION. WASHER 988 37X47X0.3	15
2340 37 47 05	POSITION. WASHER 988 37X47X0.5	15
2340 37 47 1	POSITION. WASHER 988 37X47X1	15
2340 40 50 03	POSITION. WASHER 988 40X50X0.3	15
2340 40 50 05	POSITION. WASHER 988 40X50X0.5	15
2340 40 50 1	POSITION. WASHER 988 40X50X1	15
2340 42 52 03	POSITION. WASHER 988 42X52X0.3	15
2340 42 52 05	POSITION. WASHER 988 42X52X0.5	15
2340 42 52 1	POSITION. WASHER 988 42X52X1	15

Article No.	Article Description	QTY
9000 2340 2	ASS.SHIMS 34-40MM	1
9000R 2340 2	TRAY SHIMS 34-40MM	1



Spring Type Straight Pins DIN 1481, Assortment

• 3 x 30 – 10 x 60 = 655 pieces

Contents:

Article No.	Article Description	Quantity
2860 3 30	STRAIGHT PINS 1481 3X30	50
2860 3 40	STRAIGHT PINS 1481 3X40	50
2860 4 20	STRAIGHT PINS 1481 4X20	50
2860 4 30	STRAIGHT PINS 1481 4X30	50
2860 4 40	STRAIGHT PINS 1481 4X40	50
2860 4 50	STRAIGHT PINS 1481 4X50	50
2860 5 30	STRAIGHT PINS 1481 5X30	50
2860 5 40	STRAIGHT PINS 1481 5X40	50
2860 5 50	STRAIGHT PINS 1481 5X50	25
2860 6 30	STRAIGHT PINS 1481 6X30	50
2860 6 40	STRAIGHT PINS 1481 6X40	50
2860 6 50	STRAIGHT PINS 1481 6X50	25
2860 6 60	STRAIGHT PINS 1481 6X60	25
2860 8 40	STRAIGHT PINS 1481 8X40	25
2860 8 50	STRAIGHT PINS 1481 8X50	25
2860 8 60	STRAIGHT PINS 1481 8X60	10
2860 10 50	STRAIGHT PINS 1481 10X50	10
2860 10 60	STRAIGHT PINS 1481 10X60	10



Article No.	Article Description	QTY
9000 2860	ASS.SPRTYPE STRAI.PIN 1481	1
9000R 2860	INT.SPRTYPE STR.PIN 1481	1

Lubricating Nipples DIN 71412 H1, H2, H3, Assortm.

• 150 pieces

Contents:

Article No.	Article Description	Quantity
2901 6 1	NIPPLE HEAD H1 M 6X1	10
2901 8 1	NIPPLE HEAD H1 M 8X1	20
2901 10 1	NIPPLE HEAD H1 M 10X1	10
2902 6 1	NIPPLE HEAD H2 M 6X1	10
2902 8 1	NIPPLE HEAD H2 M 8X1	20
2902 10 1	NIPPLE HEAD H2 M 10X1	10
2903 6 1	NIPPLE HEAD H3 M 6X1	10
2903 8 1	NIPPLE HEAD H3 M 8X1	20
2903 10 1	NIPPLE HEAD H3 M 10X1	10
2908 6	NIPPLE HEAD IMPACT H1 A 6	10
2908 8	NIPPLE HEAD IMPACT H1 A 8	10
2908 10	NIPPLE HEAD IMPACT H1 A 10	10



Article No.	Article Description	QTY
9000 290	ASS.LUBRICATING NIPPLES 71412	1
9000R 290	TRAY LUBRICAT.NIPPLES 71412	1

Internal / External Star Washer DIN 6798, GA, Ass.

• M4 – M12 = 1,100 pieces

Contents

Article No.	Article Description	Quantity
2351 4	SERRATED WASHER IT 6798 GA 4	100
2351 5	SERRATED WASHER IT 6798 GA 5	100
2351 6	SERRATED WASHER IT 6798 GA 6	100
2351 8	SERRATED WASHER IT 6798 GA 8	100
2351 10	SERRATED WASHER IT 6798 GA 10	100
2351 12	SERRATED WASHER IT 6798 GA 12	50
2352 4	SERRATED WASHER ET 6798 GA 4	100
2352 5	SERRATED WASHER ET 6798 GA 5	100
2352 6	SERRATED WASHER ET 6798 GA 6	100
2352 8	SERRATED WASHER ET 6798 GA 8	100
2352 10	SERRATED WASHER ET 6798 GA 10	100
2352 12	SERRATED WASHER ET 6798 GA 12	50



Article No.	Article Description	QTY
9000 235	ASS.INT./EXT.STAR WASHER 6798	1
9000R 235	INTRAY INT./EXT.STAR WASH.6798	1

Spring Washers DIN 137 A/B, Galvanized, Assortment

- For thread M3–M12 = 2,050 pieces

Contents:

Article No.	Article Description	Quantity
2321 3	SPRING WASHER137 A GA 3	200
2321 4	SPRING WASHER137 A GA 4	200
2321 5	SPRING WASHER137 A GA 5	200
2321 6	SPRING WASHER137 A GA 6	200
2321 8	SPRING WASHER137 A GA 8	200
2321 10	SPRING WASHER137 A GA 10	100
2322 4	SPRING WASHER137 B GA 4	200
2322 5	SPRING WASHER137 B GA 5	200
2322 6	SPRING WASHER137 B GA 6	200
2322 8	SPRING WASHER137 B GA 8	200
2322 10	SPRING WASHER137 B GA 10	100
2322 12	SPRING WASHER137 B GA 12	50

Article No.	Article Description	QTY
9000 232	ASS.WAVE WASHERS 137 A/B GA	1
9000R 232	TRAY WAVE WASHER 137 A/B GA	1



Brake Nipples in Assortment

- 60 pieces

Contents:

Article No.	Article Description	Quantity
3126 1	BRAKE NIP.A M10X1 SW11X16.7MM	5
3126 2	BRAKE NIP.D M10X1 SW10X16.7MM	5
3126 3	BRA.NI.H 3/8X24UNF SW14X17.5MM	5
3126 4	BRA.NI.M M10X1.25 SW10X14.2MM	5
3126 5	BRA.NI.S 3/8X24UNF SW10X18.0MM	5
3126 6	BRA.NI.TX M10X1 SW10X18.0MM	5
3126 7	BRA.NI.B 5.0 M12X1 SW12X20.0MM	5
3126 8	BRA.NI.OAA M10X1 SW14X24.0MM	5
3126 9	BRA.NI.B M12X1 SW12X18.0MM	5
3126 10	BRA.NI.E M10X1 SW14X13.0MM	5
3126 11	BRA.NI.F 3/8X24UNF SW11X21.0MM	5
3126 12	BRA.NI.OBB M12X1 SW17X29.0MM	5

Article No.	Article Description	QTY
9000 3126	ASSORTMENT BRAKE NIPPLES	1
9000R 3126	INTRAY BRAKE NIPPLES	1



Bleeder Valves in Assortment

- 130 pieces

Contents:

Article No.	Article Description	Quantity
3127 1	BLEEDER VALVE M6X1 SW 7X38.0MM	5
3127 2	BLEED.VALVE M8X1.25 SW9X32.4MM	5
3127 3	BLEED.VALVE M10X1 SW10X34.0MM	5
3127 4	BLEED.VALVE M10X1 SW10X36.0MM	5
3127 5	BLEEDER VALVE M6X1 SW 7X29.0MM	5
3127 6	BLEED.VALVE M10X1 SW11X30.0MM	5
3127 7	BLEED.VALVE M7X1 SW7X26.2MM	5
3127 8	BLEED.VALVE M7X1 SW7X28.7MM	5
3127 9	BLEED.VALVE M7X1 SW7X38.3MM	5
3127 10	BLEED.VALVE M8X1 SW9X33.5MM	5
3127 11	DUST CAP	50
3127 12	BLEED.VALVE M8X1.25 SW9X41.5MM	5
3127 13	BLEED.VALVE M8X1.25 SW9X35.5MM	5
3127 14	BLEED.VALVE M7X1 SW 7X30.5MM	5
3127 15	BLEED.VALVE M7X1 SW 9X33.0MM	5
3127 16	BLEED.VALVE M8X1 SW 8X32.0MM	5
3127 17	BLEED.VALVE M8X1.25 SW8X24.5MM	5

Article No.	Article Description	QTY
9000 3127	ASSORTMENT BLEEDER VALVES	1
9000R 3127	INTRAY BLEEDER VALVES	1



Plug Connector for Compr. Air Brake Systems Assor.

- 30 pieces
- 1x Art. No. 3423 3: pipe cutter for plastic pipes

Contents:

Article No.	Article Description	Quantity
3422 06 1	PLUG CNCTR.STRAIGHT BRASS 6MM	5
3422 06 3	PLUG CNCTR.T-SHAPE BRASS 6MM	2
3422 08 1	PLUG CNCTR.STRAIGHT BRASS 8MM	5
3422 08 3	PLUG CNCTR.T-SHAPE BRASS 8MM	2
3422 09 1	PLUG CNCTR.STRAIGHT BRASS 9MM	2
3422 10 1	PLUG CNCTR.STRAIGHT BRASS 10MM	4
3422 10 3	PLUG CNCTR.T-SHAPE BRASS 10MM	2
3422 11 1	PLUG CNCTR.STRAIGHT BRASS 11MM	2
3422 12 1	PLUG CNCTR.STRAIGHT BRASS 12MM	2
3422 12 3	PLUG CNCTR.T-SHAPE BRASS 12MM	2
3422 15 1	PLUG CNCTR.STRAIGHT BRASS 15MM	1
3423 3	LINE CUTTER FOR PLASTIC PIPE	1



Article No.	Article Description	QTY
9000 3422 1	PLUG.CON.F.C.AIR BR-SYS.ASSORT	1
9000R 3422 1	INSERT PLUG CONNECTORS	1

ABC Plug Connectors, Assortment

- Wide range of ABC plug connectors for compressed air and brake lines in Commercial vehicles
- Art. No. 9000 3427 1: made of brass with thread
- Art. No. 9000 3427 2: made of plastic without thread

Contents Art. No. 9000 3427:

Article No.	Article Description	Quantity
9000 3427 1	ASSORT.PLUG CONNECTOR ABC 1	1
9000 3427 2	ASSORT.PLUG CONNECT. ABC 2	1

Contents Art. No. 9000 3427 1:

Article No.	Article Description	Quantity
3427 1 6 10 12	CONN.STRAIGHT 6X1.0 M12X1.5	3
3427 1 8 10 12	CONN.STRAIGHT 6X1.0 M16X1.5	3
3427 1 12 15 16	CONN.STRAIGHT 8X1.0 M12X1.5	5
3427 1 16 20 16	CONN.STRAIGHT 8X1.0 M16X1.5	5
3427 1 16 20 22	CONN.STRAIGHT 8X1.0 M22X1.5	3
3427 2 6 10 16	CONN.STRAIGHT 12X1.5 M16X1.5	5
3427 2 8 10 16	CONN.STRAIGHT 12X1.5 M22X1.5	3
3427 2 8 10 22	CONN.STRAIGHT 16X2.0 M16X1.5	2
3427 2 12 15 22	CONN.STRAIGHT 16X2.0 M22X1.5	3
3427 3 12 15	CONNECTION NOZZLE REG M12X1.5	3
3427 3 14 15	CONNECTION NOZZLE REG M14X1.5	2
3427 3 16 15	CONNECTION NOZZLE REG M16X1.5	5
3427 3 22 15	CONNECTION NOZZLE REG M22X1.5	3
3427 4 16 15	CONNECTION NOZZLE HD M16X1.5	2
3427 4 22 15	CONNECTION NOZZLE HD M22X1.5	2
3427 23 8 10	STOPPER F.CONNECTOR 8X1.0	3
3427 23 12 15	STOPPER F.CONNECTOR 12X1.5	3
3427 24 18	ROTOLOCK 18 REG	1
3427 24 22	ROTOLOCK 22 REG	3
3427 24 28	ROTOLOCK 28 REG	2
3427 26 6 10	DISASSEMBL.TOOL 6X1.0	2
3427 26 8 10	DISASSEMBL.TOOL 8X1.0	2
3427 26 12 15	DISASSEMBL.TOOL 12X1.5	2
	VPK-SORTIMENT345X262X73 NR.24	1

Contents Art. No. 9000 3427 2:

Article No.	Article Description	Quantity
3427 8 6 10	CONNECTOR THREADL.REG 6X1.0	2
3427 8 8 10	CONNECTOR THREADLESS REG 8X1.0	5
3427 8 12 15	CONNECTOR THREADL. REG 12X1.5	5
3427 9 16 20	CONNECTOR THREADL. HD 16X2.0	2
3427 13	ANGLE REG 90°	5
3427 13 1	ANGLE HD 90°	2
3427 15	T-PIECE REG	3
3427 16	T-PIECE HD	1
3427 17	Y-PIECE REG	2
3427 19	REDUCING ADAPTOR	2
3427 22	CONNECTOR STRAIGHT REG	4
4076 21	SEEGER CIRC.PLIERS CURVED A 21	1

Article No.	Article Description	QTY
9000 3427	ASSORT.PLUG CONNECTOR ABC 1+2	1
9000 3427 1	ASSORT.PLUG CONNECTOR ABC 1	1
9000R 3427 1	INLETT PLUG CONNECTOR ABC 1	1
9000 3427 2	ASSORT.PLUG CONNECT. ABC 2	1
9000R 3427 2	INLETT PLUG CONNECTOR ABC 2	1



9000 3427 1



9000 3427 2

Cable Connectors, Insulated in Assortment

- 0.25 – 1.0 and 1.5 – 2.5 = 526 pieces
- 1x Art. No. 3790 11: Crimping Pliers ISO 900

Contents:

Article No.	Article Description	Quantity
3700 901	CRIMP CNCTR-RED FEMALE 6,3 901	50
3700 902	CRIMP CNCTR-BLUE FEM.6.3MM 902	50
3700 905	CRIMP CNCTR-BLUE PIGGY BL6.3MM	25
3700 906	CRIMP CNCTR-RED FEMALE 4,8 906	50
3700 907	CRIMP CNCTR-RED FEMALE 2,8 907	50
3700 912	CRIMP CNCTR-RED RING M4 912	25
3700 916	CRIMP CNCTR-BLUE RING M5 916	25
3700 917	CRIMP CNCTR-BLUE RING M6 917	25
3700 936	CRIMP CNCTR-BLUE MALE 6,3 936	50
3700 937	CRIMP CNCTR-RED MALE 6,3 937	50
3700 939	CRIMP CNCTR-BLUE BUTT 939	50
3700 941	BUTT CONNECTOR RED 941	50
3701 957	CONNECTOR SNAP-ON BLUE 957	25
3790 11	CRIMP PLIERS INSULATED 900	1

Article No.	Article Description	QTY
9000 3700	ASS.CABLE TERMINALS INSULATED	1
9000R 3700	INTRAY CABLE TERMIN.INSULATED	1



Cable Connectors, Insulated in Assortment

- 0.25 – 1.0 = 371 pieces
- 1x Art. No. 3790 11: crimp pliers insulated 900

Contents:

Article No.	Article Description	Quantity
3700 851	CRIMP CNCTR-RED INS FEMALE 6,3	25
3700 855	CRIMP CNCTR-RED PIGGY BACK RED	25
3700 901	CRIMP CNCTR-RED FEMALE 6,3 901	25
3700 906	CRIMP CNCTR-RED FEMALE 4,8 906	50
3700 907	CRIMP CNCTR-RED FEMALE 2,8 907	50
3700 912	CRIMP CNCTR-RED RING M4 912	25
3700 913	CRIMP CNCTR-RED RING M5 913	25
3700 924	CRIMP CNCTR-RED MALE BULLET 4M	25
3700 926	CRIMP CNCTR RED 4MM 926	25
3700 933	CRIMP CNCTR-RED M6 933	25
3700 937	CRIMP CNCTR-RED MALE 6,3 937	50
3700 941	BUTT CONNECTOR RED 941	50
3701 962	CONNECTOR SNAP-ON RED 962	20
3790 11	CRIMP PLIERS INSULATED 900	1

Article No.	Article Description	QTY
9000 3700 1	ASS.CABLE TERMINAL INSULAT.RED	1
9000R 3700 1	INTRAY CABLE TERMINALS INS.RED	1



Cable Connectors, Blue Insulated in Assortment

- 1.5 – 2.5 = 451 pieces
- 1x Art. No. 3790 11: crimp pliers insulated 900

Contents:

Article No.	Article Description	Quantity
3700 852	CRIMP CNCTR-BLUE INS FEM.6.3MM	25
3700 902	CRIMP CNCTR-BLUE FEM.6.3MM 902	50
3700 905	CRIMP CNCTR-BLUE PIGGY BL6.3MM	25
3700 915	CRIMP CNCTR-BLUE RING M4 915	25
3700 916	CRIMP CNCTR-BLUE RING M5 916	50
3700 917	CRIMP CNCTR-BLUE RING M6 917	50
3700 918	CRIMP CNCTR-BLUE RING M8 918	25
3700 925	CRIMP CNCTR-BLUE MALE BULLET 5	25
3700 927	CRIMP CNCTR-BLUE FEMALE BULLET	25
3700 934	CRIMP CNCTR-BLUE FEMALE 4,8	25
3700 936	CRIMP CNCTR-BLUE MALE 6,3 936	50
3700 939	CRIMP CNCTR-BLUE BUTT 939	50
3701 957	CONNECTOR SNAP-ON BLUE 957	25
3790 11	CRIMP PLIERS INSULATED 900	1

Article No.	Article Description	QTY
9000 3700 2	ASS.CABLE TERMINALS INSUL.BLUE	1
9000R 3700 2	INTRAY CABLE TERMIN.INSUL.BLUE	1



Cable Connectors, Insulated in Assortment

- 4.0 – 6.0 = 281 pieces
- 1x Art. No. 3790 11: crimp pliers insulated 900

Contents:

Article No.	Article Description	Quantity
3700 900	CRIMP CNCTR-YEL FEMALE 9,5	25
3700 904	CRIMP CNCTR-YEL FEMALE 6,3	25
3700 920	CRIMP CNCTR-YEL RING M5	25
3700 921	CRIMP CNCTR-YEL RING M6	25
3700 922	CRIMP CNCTR-YEL RING M 8	25
3700 923	CRIMP CNCTR-YEL RING M10	15
3700 928	CRIMP CNCTR-YEL MALE BULLET 5M	25
3700 929	CRIMP CNCTR-YEL FEMALE BULLET	25
3700 932	CRIMP CNCTR-YELLOW SPADE M5	15
3700 935	CRIMP CNCTR-YEL MALE 6,3	25
3700 940	CRIMP CNCTR-YEL BUTT	25
3700 972	CRIMP CNCTR-YEL SPADE M6	15
3701 964	CONNECTOR SNAP-ON YELLOW 964	10
3790 11	CRIMP PLIERS INSULATED 900	1



Article No.	Article Description	QTY
9000 3700 3	ASS.CABLE TERMIN.INSUL.YELLOW	1
9000R 3700 3	INTRAY CABLE TERMIN.INS.YELLOW	1

Heat Shrink Connectors in Assortment

- 161 pieces
- 1x Art. No. 3790 11: crimp pliers insulated 900

Contents:

Article No.	Article Description	Quantity
3702 801	H SRNK QK CONN.FEMALE RED 6.3	10
3702 802	H SRNK QK CONN.FEMALE BLUE 6.3	10
3702 812	H SRNK RING TERMINAL RED M4	10
3702 813	H SRNK RING TERMINAL RED M5	10
3702 816	H SRNK RING TERMINAL BLUE M5	10
3702 817	H SRNK RING TERMINAL BLUE M6	10
3702 818	H SRNK RING TERMINAL BLUE M8	10
3702 833	H SRNK RING TERMINAL RED M6	10
3702 836	H SRNK QK CONN.MALE BLUE6.3	10
3702 837	H SRNK QK CONN.MALE RED 6.3	10
3702 839	H SRNK BUTT CONNECT.BLUE 839	30
3702 840	H SRNK BUTT CONNECT.YELLOW 840	10
3702 841	H SRNK BUTT CONNECT.RED 841	20
3790 11	CRIMP PLIERS INSULATED 900	1



Article No.	Article Description	QTY
9000 3702	ASSORT.HEAT SHRINK CONNECTORS	1
9000R 3702	INTRAY HEAT SHRINK CONNECTORS	1

Multicore Cable Ends in Assortment

- Insulated / non-insulated = 901 pieces

Contents:

Article No.	Article Description	Quantity
3711 15 7	CBL END SLEEVE UNINSUL. 1.5X7	100
3711 15 12	CBL END SLEEVE UNINSUL. 1.5X12	100
3711 25 7	CBL END SLEEVE UNINSUL. 2.5X7	100
3711 25 12	CBL END SLEEVE UNINSUL. 2.5X12	100
3711 4 12	CBL END SLEEVE UNINSULAT. 4X12	100
3711 6 15	CBL END SLEEVE UNINSULAT. 6X15	100
3713 05 155	CBL END SLEEVE 0.5HL WHITE	50
3713 075 14	CBL END SLE.ISO.DIN 0.75N GREY	50
3713 1 14	CBL END SLE.ISO.DIN/B 1N RED	50
3713 15 14	CBL END SLE.ISO.DIN/B 1.5N BLA	50
3713 25 15	CBL END SLE.ISO.DIN/A 2.5NBLUE	50
3713 4 168	CBL END SLEEVE 4N GREY	25
3713 6 20	CBL END SLEEVE 6N YELLOW	25
3790 4	MULTICORE CABLE END PLIERS 143	1



Article No.	Article Description	QTY
9000 371	ASS.MULTICORE CABLE END	1
9000R 371	TRAY MULTICORE CABLE END	1

Truck – Electronic Plugs, Assortment

- 450 pieces
- Suitable for truck and bus models of the brands Mack, Volvo, Renault, MAN and Neoplan

Contents:

Article No.	Article Description	Quantity
3704 500	ELECTRONIC PLUGS 500	25
3704 501	ELECTRONIC PLUGS 501	25
3704 502	ELECTRONIC PLUGS 502	25
3704 510	ELECTRONIC PLUGS 510	25
3704 511	ELECTRONIC PLUGS 511	25
3704 512	ELECTRONIC PLUGS 512	25
3704 520	ELECTRONIC PLUGS 520	25
3704 521	ELECTRONIC PLUGS 521	25
3704 530	ELECTRONIC PLUGS 530	25
3704 531	ELECTRONIC PLUGS 531	25
3704 540	WIRE SEAL MKR/S 0,35-0,5 BLUE	25
3704 541	WIRE SEAL MKR/S 0,75-1,0 RED	25
3704 542	WIRE SEAL MKR/S 1,5 YELLOW	25
3704 543	WIRE SEAL MKR/S 2,5 BROWN	25
3704 544	SEALING PLUGS MKR/MKS GREEN	25
3704 550	WIRE SEAL VKR/S 0,5-1,0 BOWN	25
3704 551	WIRE SEAL VKR/S 1,5-2,5 GRAY	25
3704 552	SEALING PLUGS VKR/VKS GREEN	25



Article No.	Article Description	QTY
9000 3704 5	SORT.ELEKTRONIK-STECKER NFZ	1
9000R 3704 5	INLETT ELEKTRONIK-STECKER NFZ	1

Waterproof Plug Connectors, Assortment

- 648 pieces

Contents:

Article No.	Article Description	Quantity
3704 613	FEMALE CONTACT 0.5-1.5MM ²	100
3704 627	MALE CONTACT 0.5-1.5MM ²	100
3718 1	HOUSING F FEM CONN 1-POLE	4
3718 1 1	HOUSING F MALE CONN 1-POLE	4
3718 2	HOUSING F FEM CONN 2-POLE	4
3718 2 2	HOUSING F MALE CONN 2-POLE	4
3718 3	HOUSING F FEM CONN 3-POLE	4
3718 3 3	HOUSING F MALE CONN 3-POLE	4
3718 4	HOUSING F FEM CONN 4-POLE	4
3718 4 4	HOUSING F MALE CONN 4-POLE	4
3718 5	HOUSING F FEM CONN 5-POLE	4
3718 5 5	HOUSING F MALE CONN 5-POLE	4
3718 6	HOUSING F FEM CONN 6-POLE	4
3718 6 6	HOUSING F MALE CONN 6-POLE	4
3718 12	DUMMY PLUG	100
3718 13	GASKET GREEN 1.4-1.7MM	100
3718 14	GASKET YELLOW 1.8-2.4MM	100
3718 15	GASKET RED 2.6-3.3MM	100



Article No.	Article Description	QTY
9000 3718	ASS.WATERPROOF PLUG CONNECTORS	1
9000R 3718	INTRAY WATERPROOF PLUG CONNec.	1

VW - Electronic Connectors in Assortment

• 500 pieces

Contents:

Article No.	Article Description	Quantity
3704 666	ELECTRONIC PLUG 666	50
3704 667	ELECTRONIC PLUG 667	50
3704 668	ELECTRONIC PLUG 668	50
3704 669	ELECTRONIC PLUG 669	50
3704 670	ELECTRONIC PLUG 670	50
3704 671	ELECTRONIC PLUG 671	50
3704 672	ELECTRONIC PLUG 672	50
3704 673	ELECTRONIC PLUG 673	50
3704 674	ELECTRONIC PLUG 674	50
3704 675	ELECTRONIC PLUG 675	50



Article No.	Article Description	QTY
9000 3704 2	ASS.ELECTR.CONNECTOR VW	1
9000R 3704 2	TRAY ELECTRONIC CONNECTOR VW	1

Shrink / Soldering Connectors in Assortment

• 125 pieces

Contents:

Article No.	Article Description	Quantity
3702 539	HS-SOLD.BUTT CNCTR BLUE 539	10
3702 540	HS-SOLD.BUTT CNCTR YELLOW 540	5
3702 541	HS-SOLD.BUTT CNCTR RED 541	10
3702 817	H SRNK RING TERMINAL BLUE M6	10
3702 821	H SRNK RING TERMINAL YELLOW M6	10
3702 833	H SRNK RING TERMINAL RED M6	10
3702 839	H SRNK BUTT CONNECT.BLUE 839	20
3702 841	H SRNK BUTT CONNECT.RED 841	20
3731 48	HEAT SHRINK TUBE 100MM 4.8	15
3731 64	HEAT SHRINK TUBE 100MM 6.4	15
5482 50	HOT-SPOT MINI GAS TORCH	1



Article No.	Article Description	QTY
9000 370	ASS.SHRINK/SOLDERING CONNECTOR	1
9000R 370	INTRAY SHRINK/SOLDERING CNCTR.	1

Heat Shrink Tube Assortment 2:1

• 2.4 – 25.4 = 120 pieces

Contents:

Article No.	Article Description	Quantity
3731 24	HEAT SHRINK TUBE 100MM 2.4	25
3731 32	HEAT SHRINK TUBE 100MM 3.2	25
3731 48	HEAT SHRINK TUBE 100MM 4.8	20
3731 64	HEAT SHRINK TUBE 100MM 6.4	15
3731 95	HEAT SHRINK TUBE 100MM 9.5	15
3731 127	HEAT SHRINK TUBE 100MM 12.7	10
3731 190	HEAT SHRINK TUBE 100MM 19.0	5
3731 254	HEAT SHRINK TUBE 100MM 25.4	5



Article No.	Article Description	QTY
9000 3731	ASSORTMENT SHRINK TUBES 2:1	1
9000R 3731	TRAY HEAT SHRINK TUBING	1

Heat-Shrink Tubing 3:1, Butt Connector Assortment

- Heat shrink tubing: 3–19 mm = 55 pieces
- Butt connectors: 0.5–6.0 mm² = 70 pieces

Contents:

Article No.	Article Description	Quantity
3702 839	H SRNK BUTT CONNECT.BLUE 839	30
3702 840	H SRNK BUTT CONNECT.YELLOW 840	20
3702 841	H SRNK BUTT CONNECT.RED 841	20
3733 3	HEAT SHRINK TUBING IK 100MM3/1	20
3733 6	HEAT SHRINK TUBING IK 100MM6/2	10
3733 9	HEAT SHRINK TUBING IK 100MM9/3	10
3733 12	HEAT SHRINK TUBING IK100MM12/4	10
3733 19	HEAT SHRINK TUBING IK100MM19/6	5

Article No.	Article Description	QTY
9000 3733	ASS.HEAT SHRINK TUBING 3:1 IK	1
9000R 3733	TRAY HEAT SHRINK TUBING 3:1 IK	1



Solder Ring Tongues DIN 46211, Assortment

• M6 – M12 = 42 pieces

Contents:

Article No.	Article Description	Quantity
3705 780	SOLDER RING TERM.10-16 M6	5
3705 781	SOLDER RING TERM.10-16 M8	5
3705 782	SOLDER RING TERM.10-16 M10	5
3705 783	SOLDER RING TERM.10-16 M12	5
3705 784	SOLDER RING TERM.16-25 M8	5
3705 785	SOLDER RING TERM.16-25 M10	5
3705 787	SOLDER RING TERM.25-35 M8	2
3705 788	SOLDER RING TERM.25-35 M10	2
3705 789	SOLDER RING TERM.25-35 M12	2
3705 790	SOLDER RING TERM.35-50 M8	2
3705 791	SOLDER RING TERM.35-50 M10	2
3705 792	SOLDER RING TERM.35-50 M12	2

Article No.	Article Description	QTY
9000 3705	ASSORTMENT SOLDER RING TONGUES	1
9000R 3705	TRAY SOLDER RING TONGUES	1



Cable Terminal with Check-Hole in Assortment

• M6 – M12 = 45 pieces

Contents:

Article No.	Article Description	Quantity
3705 8 10 6	PIPE CABLE LUGS 10 M 6	5
3705 8 10 8	PIPE CABLE LUGS 10 M 8	5
3705 8 16 6	PIPE CABLE LUGS 16 M 6	5
3705 8 16 8	PIPE CABLE LUGS 16 M 8	5
3705 8 25 6	PIPE CABLE LUGS 25 M 6	5
3705 8 25 8	PIPE CABLE LUGS 25 M 8	5
3705 8 25 10	PIPE CABLE LUGS 25 M 10	5
3705 8 35 8	PIPE CABLE LUGS 35 M 8	2
3705 8 35 10	PIPE CABLE LUGS 35 M 10	2
3705 8 50 8	PIPE CABLE LUGS 50 M 8	2
3705 8 50 10	PIPE CABLE LUGS 50 M 10	2
3705 8 50 12	PIPE CABLE LUGS 50 M 12	2

Article No.	Article Description	QTY
9000 3705 1	ASS.CABLE TERMINAL	1
9000R 3705 1	TRAY CABLE TERMINAL	1



Crimping Lugs with Check-Hole in Assortment

• M6 – M12 = 45 pieces

Contents:

Article No.	Article Description	Quantity
3705 9 10 6	COMPRESSION TERMINAL 10 M 6	5
3705 9 10 8	COMPRESSION TERMINAL 10 M 8	5
3705 9 16 6	COMPRESSION TERMINAL 16 M 6	5
3705 9 16 8	COMPRESSION TERMINAL 16 M 8	5
3705 9 25 6	COMPRESSION TERMINAL 25 M 6	5
3705 9 25 8	COMPRESSION TERMINAL 25 M 8	5
3705 9 25 10	COMPRESSION TERMINAL 25 M 10	5
3705 9 35 8	COMPRESSION TERMINAL 35 M 8	2
3705 9 35 10	COMPRESSION TERMINAL 35 M 10	2
3705 9 50 8	COMPRESSION TERMINAL 50 M 8	2
3705 9 50 10	COMPRESSION TERMINAL 50 M 10	2
3705 9 50 12	COMPRESSION TERMINAL 50 M 12	2

Article No.	Article Description	QTY
9000 3705 2	ASSORTMENT CRIMPING LUG	1
9000R 3705 2	TRAY CRIMPING LUG	1



Automotive Fuses, Assortment

- 2A – 30A = 576 pieces
- 1x Art. No. 3810 1: fuse removal tool

Contents:

Article No.	Article Description	Quantity
3810 1	BLADE FUSE REMOVAL TOOL	1
3810 2	BLADE FUSE STD 2A	25
3810 3	BLADE FUSE STD 3A	25
3810 5	BLADE FUSE STD 5A	25
3810 75	BLADE FUSE STD 7.5A	25
3810 10	BLADE FUSE STD 10A	50
3810 15	BLADE FUSE STD 15A	50
3810 20	BLADE FUSE STD 20A	25
3810 25	BLADE FUSE STD 25A	25
3810 30	BLADE FUSE STD 30A	25
3811 5	AUTO.FUSE 5A YELLOW	50
3811 8	AUTO.FUSE 8A WHITE	50
3811 16	AUTO.FUSE 16A RED	50
3811 25	AUTO.FUSE 25A BLUE	50
3812 2	GLASS FUSE 2A 5.0X20	20
3812 5 5	GLASS FUSE 5A 5.0X20	20
3812 10	GLASS FUSE 10A 6.3X32	20
3812 15	GLASS FUSE 15A 6.3X32	20
3812 20	GLASS FUSE 20A 6.3X32	20



Article No.	Article Description	QTY
9000 381	ASSORTMENT AUTOMOTIVE FUSES	1
9000R 381	TRAY AUTOMOTIVE FUSES	1

Blade Fuses Mini / Maxi, Assortment

- Mini: 2 A – 30 A = 50 pieces
- Maxi: 20 A – 100 A = 40 pieces

Contents:

Article No.	Article Description	Quantity
3808 2	MINI BLADE FUSE 2A	5
3808 3	MINI BLADE FUSE 3A	5
3808 4	MINI BLADE FUSE 4A	5
3808 5	MINI BLADE FUSE 5A	5
3808 75	MINI BLADE FUSE 7.5A	5
3808 10	MINI BLADE FUSE 10A	5
3808 15	MINI BLADE FUSE 15A	5
3808 20	MINI BLADE FUSE 20A	5
3808 25	MINI BLADE FUSE 25A	5
3808 30	MINI BLADE FUSE 30A	5
3809 20	MAXI BLADE FUSE 20A	5
3809 30	MAXI BLADE FUSE 30A	5
3809 40	MAXI BLADE FUSE 40A	5
3809 50	MAXI BLADE FUSE 50A	5
3809 60	MAXI BLADE FUSE 60A	5
3809 70	MAXI BLADE FUSE 70A	5
3809 80	MAXI BLADE FUSE 80A	5
3809 100	MAXI BLADE FUSE 100A	5



Article No.	Article Description	QTY
9000 380	ASS.BLADE FUSES MINI/MAXI	1
9000R 380	TRAY BLADE FUSES MINI/MAXI	1

Pal Fuses for Japanese Vehicles, Assortment

- With sleeve: 30 A – 100 A = 12 pieces
- With tongue: 30 A – 100 A = 12 pieces

Contents:

Article No.	Article Description	Quantity
3806 30	BLOCK FUSE TYPE"B" 30A PINK	2
3806 40	BLOCK FUSE TYPE"B" 40A GREEN	2
3806 50	BLOCK FUSE TYPE"B" 50A RED	2
3806 60	BLOCK FUSE TYPE"B" 60A YELLOW	2
3806 80	BLOCK FUSE TYPE"B" 80A BLACK	2
3806 100	BLOCK FUSE TYPE"B" 100A BLUE	2
3807 30	BLOCK FUSE TYPE"AS" 30A PINK	2
3807 40	BLOCK FUSE TYPE"AS" 40A GREEN	2
3807 50	BLOCK FUSE TYPE"AS" 50A RED	2
3807 60	BLOCK FUSE TYPE"AS" 60A YELLOW	2
3807 80	BLOCK FUSE TYPE"AS" 80A BLACK	2
3807 100	BLOCK FUSE TYPE"AS" 100A BLUE	2



Article No.	Article Description	QTY
9000 3807	ASS.PAL FUSES FOR JAP.VEHICLES	1
9000R 3807	TRAY PAL FUSES F. JAP.VEHICLES	1

Micro II & III Blade-Type Automotive Fuses, Assor.

- New generation US vehicles / Fiat
- Micro III, 5-15 ampere, 25 pcs
- Micro II, 5-30 ampere, 25 pcs
- 1 x Art. No. 3810 1: Fuse extractor
- 276-part

Contents:

Article No.	Article Description	Quantity
3810 1	BLADE FUSE REMOVAL TOOL	1
3814 5 2	BLADE FUSE MICRO II 5A	25
3814 5 3	BLADE FUSE MICRO III 5A	25
3814 7 5 2	BLADE FUSE MICRO II 7,5A	25
3814 7 5 3	BLADE FUSE MICRO III 7,5A	25
3814 10 2	BLADE FUSE MICRO II 10 A	25
3814 10 3	BLADE FUSE MICRO III 10A	25
3814 15 2	BLADE FUSE MICRO II 15 A	25
3814 15 3	BLADE FUSE MICRO III 15A	25
3814 20 2	BLADE FUSE MICRO II 20 A	25
3814 25 2	BLADE FUSE MICRO II 25 A	25
3814 30 2	BLADE FUSE MICRO II 30 A	25



Article No.	Article Description	QTY
9000 3814 23	ASS.BLADE TYP.FUSES MICRO 2/3	1
9000R 3814 23	INLETT BLADE FUSES MICRO 2/3	1

Block Fuses Type „J / JM / JLP“, assortment

- Fuse type 'J', 20 – 60 ampere, 2 pcs. each
- Fuse type 'JM', 15 – 40 ampere, 2 pcs. each
- Fuse type 'JLP', 20 – 60 ampere, 2 pcs. each
- 34 pcs.

Contents:

Article No.	Article Description	Quantity
3816 20	BLOCK FUSE TYPE"J" 20A LT BLUE	2
3816 25	BLOCK FUSE TYPE"J" 25A WHITE	2
3816 30	BLOCK FUSE TYPE"J" 30A PINK	2
3816 40	BLOCK FUSE TYPE"J" 40A GREEN	2
3816 50	BLOCK FUSE TYPE"J" 50A RED	2
3816 60	BLOCK FUSE TYPE"J" 60A YELLOW	2
3818 20	BLOCK FU.TYPE"JLP" 20A LT BLUE	2
3818 25	BLOCK FU.TYPE"JLP"25A WHITE	2
3818 30	BLOCK FUSE TYPE"JLP" 30A PINK	2
3818 40	BLOCK FUSE TYPE"JLP" 40A GREEN	2
3818 50	BLOCK FUSE TYPE"JLP" 50A RED	2
3818 60	BLOCK FUSE TYPE"JLP"60A YELLOW	2
3818 1 15	BLOCK FU.TYPE"JM" 15A GREY	2
3818 1 20	BLOCK FUSE TYPE"JM" 20A H-BLUE	2
3818 1 25	BLOCK FUSE TYPE"JM" 25A WHITE	2
3818 1 30	BLOCK FUSE TYPE"JM" 30A PINK	2
3818 1 40	BLOCK FUSE TYPE"JM" 40A GREEN	2



Article No.	Article Description	QTY
9000 3818	ASSORTM.BLOCK FUSES J/JM/JLP"	1
9000R 3818	INLAY BLOCK FUSES J/JM/JLP"	1

Blade Fuses Micro in Assortment

- 2 A–30 A = 250 pieces

Contents:

Article No.	Article Description	Quantity
3814 2	MICRO BLADE FUSE 2A	25
3814 3	MICRO BLADE FUSE 3A	25
3814 4	MICRO BLADE FUSE 4A	25
3814 5	MICRO BLADE FUSE 5A	25
3814 7.5	MICRO BLADE FUSE 7.5A	25
3814 10	MICRO BLADE FUSE 10A	25
3814 15	MICRO BLADE FUSE 15A	25
3814 20	MICRO BLADE FUSE 20A	25
3814 25	MICRO BLADE FUSE 25A	25
3814 30	MICRO BLADE FUSE 30A	25

Article No.	Article Description	QTY
9000 3814	ASSORTM.BLADE FUSES MICRO	1
9000R 3814	TRAY BLADE FUSES MICRO	1



Blade Fuses Mini in Assortment

- 2 A–30 A = 100 pieces

Contents:

Article No.	Article Description	Quantity
3808 2	MINI BLADE FUSE 2A	10
3808 3	MINI BLADE FUSE 3A	10
3808 4	MINI BLADE FUSE 4A	10
3808 5	MINI BLADE FUSE 5A	10
3808 7.5	MINI BLADE FUSE 7.5A	10
3808 10	MINI BLADE FUSE 10A	10
3808 15	MINI BLADE FUSE 15A	10
3808 20	MINI BLADE FUSE 20A	10
3808 25	MINI BLADE FUSE 25A	10
3808 30	MINI BLADE FUSE 30A	10

Article No.	Article Description	QTY
9000 3808	ASSORTMENT BLADE FUSES MINI	1
9000R 3808	TRAY BLADE FUSES MINI	1



Blade Fuses in Assortment

- 2 A – 40 A = 257 pieces
- 1x Art. No. 3810 1: fuse removal tool

Contents:

Article No.	Article Description	Quantity
3810 1	BLADE FUSE REMOVAL TOOL	1
3810 2	BLADE FUSE STD 2A	25
3810 3	BLADE FUSE STD 3A	25
3810 5	BLADE FUSE STD 5A	25
3810 7.5	BLADE FUSE STD 7.5A	25
3810 10	BLADE FUSE STD 10A	25
3810 15	BLADE FUSE STD 15A	25
3810 20	BLADE FUSE STD 20A	25
3810 25	BLADE FUSE STD 25A	25
3810 30	BLADE FUSE STD 30A	25
3810 40	BLADE FUSE STD 40A	25
3815 3810	STAND.BLADE FUSE HOLD.W.CUTTER	5
3815 3810 2	BLADE FUSE HOLDER+CNCTR 6.3MM	2

Article No.	Article Description	QTY
9000 3810	ASSORTMENT BLADE FUSES STD	1
9000R 3810	TRAY BLADE FUSES	1



Blade Fuses Maxi in Assortment

• 20 A – 100 A = 40 pieces

Contents:

Article No.	Article Description	Quantity
3809 20	MAXI BLADE FUSE 20A	5
3809 30	MAXI BLADE FUSE 30A	5
3809 40	MAXI BLADE FUSE 40A	5
3809 50	MAXI BLADE FUSE 50A	5
3809 60	MAXI BLADE FUSE 60A	5
3809 70	MAXI BLADE FUSE 70A	5
3809 80	MAXI BLADE FUSE 80A	5
3809 100	MAXI BLADE FUSE 100A	5

Article No.	Article Description	QTY
9000 3809	ASSORTMENT BLADE FUSES MAXI	1
9000R 3809	TRAY BLADE FUSES MAXI	1



Midi Blade Fuses in Assortment

• 30 A – 200 A = 50 pieces

Contents:

Article No.	Article Description	Quantity
3819 30	MIDI BLADE FUSE 30A	5
3819 40	MIDI BLADE FUSE 40A	5
3819 50	MIDI BLADE FUSE 50A	5
3819 60	MIDI BLADE FUSE 60A	5
3819 70	MIDI BLADE FUSE 70A	5
3819 80	MIDI BLADE FUSE 80A	5
3819 100	MIDI BLADE FUSE 100A	5
3819 125	MIDI BLADE FUSE 125A	5
3819 150	MIDI BLADE FUSE 150A	5
3819 200	MIDI BLADE FUSE 200A	5

Article No.	Article Description	QTY
9000 3819	ASSORTMENT BLADE FUSES MIDI	1
9000R 3819	TRAY BLADE FUSES MIDI	1



Mega Blade Fuses in Assortment

• 100 A – 500 A = 50 pieces

Contents:

Article No.	Article Description	Quantity
3819 100 1	MEGA BLADE FUSE 100A	5
3819 125 1	MEGA BLADE FUSE 125A	5
3819 150 1	MEGA BLADE FUSE 150A	5
3819 175 1	MEGA BLADE FUSE 175A	5
3819 200 1	MEGA BLADE FUSE 200A	5
3819 225 1	MEGA BLADE FUSE 225A	5
3819 250 1	MEGA BLADE FUSE 250A	5
3819 300 1	MEGA BLADE FUSE 300A	5
3819 400 1	MEGA BLADE FUSE 400A	5
3819 500 1	MEGA BLADE FUSE 500A	5

Article No.	Article Description	QTY
9000 3819 1	ASSORTMENT BLADE FUSES - MEGA	1
9000R 3819 1	TRAY BLADE FUSES - MEGA	1



Plastic Bulbs 24V in Assortment

• 85 pieces

Contents:

Article No.	Article Description	Quantity
3802 1638	24V 2W BULB PLAST.BASE EBS-P28	5
3802 1662	24V 1.2W BULB PLAST.BASE.B8.5D	5
3802 1668	24V 2.4W BULB PLASTIC BASE B9	5
3802 1672	24V1.2W BULB PLAST.BASE EBS R6	5
3802 1673	24V1.2W BULB PLAS.BASE EBS-N10	5
3802 1674	24V1.4W BULB PLAST.BASE EBSP29	5
3802 1675	28V30MA BU.PLA.BAS.KW2X4,6D-12	5
3802 1676	24V1.6W BULB PLAST.BASE EBS N7	5
3802 1677	28V 53MA BU.PLAS.BA.KW2X4,6D-4	5
3802 1678	24V1.2W BULB PLAST.BASE BX8,5D	5
3802 1680	24V1W BULB PLAST.BASE KW2X4.6D	5
3802 1682	24V 1.2W BULB PLAST.BASE B8.3D	5
3802 1687	24V 3W BULB PLAST.BASE EBS-N	5
3802 1693	24V 1.4W BULB PLAST.BAS.EBSR11	5
3802 1697	24V1.2W BULB PLAST.BASE EBS R4	5
3802 1698	24V1.2W BULB PLAS.BASE EBS-R10	5
3802 1699	24V1.2W BULB PLAS.BASE EBS-R12	5



Article No.	Article Description	QTY
9000 3802	PLASTIC BULB 24V IN PROD.RANGE	1
9000R 3802	INTRAY PLASTIC BULB 24V	1

White Plastic Cable Clips, Assortment

• 550 pieces

Contents:

Article No.	Article Description	Quantity
3765 200 31	CABLE CLAMPS PLSTC.WH Ø 3,1MM	100
3765 200 50	CABLE CLAMPS PLSTC. WH Ø 5,0MM	100
3765 200 64	CABLE CLAMPS PLSTC.WH Ø 6,4MM	100
3765 200 79	CABLE CLAMPS PLSTC.WH Ø 7,9MM	100
3765 200 95	CABLE CLAMPS PLSTC.WH Ø 9,5MM	50
3765 200 127	CABLE CLAMPS PLSTC.WH Ø12,7MM	50
3765 200 158	CABLE CLAMPS PLSTC.WH Ø15,8MM	25
3765 200 194	CABLE CLAMPS PLSTC.WH Ø19,4MM	25



Article No.	Article Description	QTY
9000 3765 1	ASSORT.CABLE CLIPS PLSTC WHITE	1
9000R 3765 1	INLETT CABLE CLIPS PLSTC WHITE	1

Automotive Special Bulbs 12 V, Assortment

- 128 pieces
- In practical assortment box
- Every special bulb is immediately accessible
- Assembly with few pieces

Art. No. 3801 1696:

- suitable for dashboard illumination at VW T 4

Contents:

Article No.	Article Description	Quantity
3801 1603	12V 1.2W WEDGE BASE BULB MAT	10
3801 1608	12V 1.2W BULB GLASS PLST.WHITE	10
3801 1609	12V 0.5W BULB GLASS PLST.	10
3801 1624	12V 5W WEDGE BASE BULB ORANGE	5
3801 1641	12V 1.2W BULB PLAST.BASE B8.4D	10
3801 1644	12V1.5W BULB PLAS. BASE BX8.4D	5
3801 1645	12V 2W BULB PLASTIC BASE B8.4D	10
3801 1651	12V1.2W BULB PLAST.BASE B 8.7D	10
3801 1661	12V 1.2W BULB PLAST.BASE B8.5D	10
3801 1665	12V 2W BULB PLASTIC BASE B8.3D	10
3801 1671	12V 1.2W BULB PLAST.BASE B8.3D	10
3801 1695	14V 1.4W BULB PLASTIC BASE HRQ	5
3801 1696	12V 1.8W BULB PLAS.BASE EBSR11	5
3801 1735	12V 10W BULB TUB.28MM SV8.5-8	10
3801 1836	12V 5W BULB MINI HALOGEN BA9S	2
3801 1837	12V 10W BULB MINI HALOGEN BA9S	2
3801 1898	12V 3W BULB MINI HALOGEN B10D	2
3801 1899	12V 5W BULB MINI HALOGEN B10D	2

Article No.	Article Description	QTY
9000 3801 1	ASSORT.12VSPEC.LAMPS.AUTOMOT.	1
9000R 3801 1	TICK 12V SPEC.LAMPS.AUTOMOT.	1

Technical Data

Art. No.	Base	Application
3801 1603	W 2x4,6d	Mercedes
3801 1608	W 2x4,6d weiß	Mercedes
3801 1609	W 2x4,6d	Opel, Mercedes
3801 1624	W 2,1x9,5d	Side turn signal Mercedes, Opel
3801 1641	B 8,4d	VDO, Moto Meter
3801 1644	BX 8,4d	BMW 3er, 8er, Audi, MB E-, S-, SL-, SLK-Klasse, Porsche
3801 1645	B 8,4d	VDO, Moto Meter
3801 1651	B 8,7d	Ford
3801 1661	B 8,5d	BMW, Ford, Mercedes, Porsche
3801 1665	B 8,5d	Audi, Renault
3801 1671	B 8,3d	VW, Audi
3801 1695	HRQ	Fiat, Alfa, Saab
3801 1696	EBS	Volvo
3801 1735	Soffite 11 x 30	Japanese interior
3801 1836	Halogen Ba 9s	Mercedes interior
3801 1837	Halogen Ba 9s	BMW interior
3801 1898	Halogen B 10d	Opel, Ford
3801 1899	Halogen B 10d	Opel, Ford

Steel Cable Clips DIN 72571, GA, Assortment

- 4–20 mm = 170 pieces

Contents:

Article No.	Article Description	Quantity
3765 4	CABLE CLAMPS 4	25
3765 5	CABLE CLAMPS 5	25
3765 6	CABLE CLAMPS 6	25
3765 8	CABLE CLAMPS 8	25
3765 10	CABLE CLAMPS 10	25
3765 12	CABLE CLAMPS 12	25
3765 15	CABLE CLAMPS 15	10
3765 20	CABLE CLAMPS 20	10

Article No.	Article Description	QTY
9000 3765	ASS.STEEL CABLE CLIPS72571 GA.	1
9000R 3765	TRAY STEEL CABLE CLIPS 72571	1



RSGU Clamps in Assortment

- Contents: 60 pieces
- Width: from 12 mm Ø 5 mm to 15 mm Ø 25 mm

Contents:

Article No.	Article Description	Quantity
3232 5	RSGU RUB/STEEL CLAMP B 12 5MM	5
3232 6	RSGU RUB/STEEL CLAMP B 12 6MM	5
3232 8	RSGU RUB/STEEL CLAMP B 12 8MM	5
3232 10	RSGU RUB/STEEL CLAMP B 12 10MM	5
3232 12	RSGU RUB/STEEL CLAMP B 12 12MM	5
3233 14	RSGU RUB/STEEL CLAMP B 15 14MM	5
3233 15	RSGU RUB/STEEL CLAMP B 15 15MM	5
3233 16	RSGU RUB/STEEL CLAMP B 15 16MM	5
3233 18	RSGU RUB/STEEL CLAMP B 15 18MM	5
3233 20	RSGU RUB/STEEL CLAMP B 15 20MM	5
3233 22	RSGU RUB/STEEL CLAMP B 15 22MM	5
3233 25	RSGU RUB/STEEL CLAMP B 15 25MM	5

Article No.	Article Description	QTY
9000 3232	ASSORTMENT RSGU CLAMPS	1
9000R 3232	TRAY RSGU CLAMPS	1



Grommet PVC in Assortment

- 10 mm–28 mm = 250 pieces

Contents:

Article No.	Article Description	Quantity
3780 10	GROMMET PVC 10MM	25
3780 11	GROMMET PVC 11MM	25
3780 12	GROMMET PVC 12MM	25
3780 14	GROMMET PVC 14MM	25
3780 16	GROMMET PVC 16MM	25
3780 18	GROMMET PVC 18MM	25
3780 20	GROMMET PVC 20MM	25
3780 22	GROMMET PVC 22MM	25
3780 26	GROMMET PVC 26MM	25
3780 28	GROMMET PVC 28MM	25

Article No.	Article Description	QTY
9000 3780	ASSORTMENT GROMMETS	1
9000R 3780	TRAY GROMMETS	1



Grommet, Double-Sided PVC in Assortment

• 6 mm - 31 mm = 215 pieces

Contents:

Article No.	Article Description	Quantity
3785 6	GROMMET DOUBLE-SIDED 6MM/1,5	25
3785 9	GROMMET DOUBLE-SIDED 9MM/1	25
3785 10	GROMMET DOUBLE-SIDED 10MM/2	25
3785 11	GROMMET DOUBLE-SIDED 11MM/1	25
3785 12	GROMMET DOUBLE-SIDED 12MM/1,5	25
3785 21	GROMMET DOUBLE-SIDED 21MM/4	25
3785 21 1	GROMMET DOUBLE-SIDED 21MM/2	25
3785 24	GROMMET DOUBLE-SIDED 24MM/3	20
3785 30	GROMMET DOUBLE-SIDED 30MM/3,5	10
3785 31	GROMMET DOUBLE-SIDED 31MM/1,5	10
	VPK-SORTIMENT345X262X73 NR.24	1

Article No.	Article Description	QTY
9000 3785	ASSORTM.GROMMETS DOUBLE-SIDED	1
9000R 3785	TRAY GROMMETS DOUBLE-SIDED	1



Sealing Plugs PVC I in Assortment

• 6.4 mm – 32.0 mm = 195 pieces

Contents:

Article No.	Article Description	Quantity
3781 64	SEALING PLUG PVC 6.4MM	25
3781 80	SEALING PLUG PVC 8.0MM	25
3781 95	SEALING PLUG PVC 9.5MM	25
3781 125	SEALING PLUG PVC 12.5MM	25
3781 155	SEALING PLUG PVC 15.5MM	20
3781 190	SEALING PLUG PVC 19.0MM	20
3781 200	SEALING PLUG PVC 20.0MM	20
3781 225	SEALING PLUG PVC 22.5MM	15
3781 254	SEALING PLUG PVC 25.4MM	10
3781 320	SEALING PLUG PVC 32.0MM	10

Article No.	Article Description	QTY
9000 3773	ASS.SEALING PLUG PVC I	1
9000R 3773	TRAY SEALING PLUG PVC I	1



Sealing Plugs PVC II in Assortment

• 4.7 mm – 51.5 mm = 315 pieces

Contents:

Article No.	Article Description	Quantity
3781 47	SEALING PLUG PVC 4.7MM	25
3781 64	SEALING PLUG PVC 6.4MM	25
3781 80	SEALING PLUG PVC 8.0MM	25
3781 95	SEALING PLUG PVC 9.5MM	25
3781 115	SEALING PLUG PVC 11.5MM	25
3781 125	SEALING PLUG PVC 12.5MM	25
3781 149	SEALING PLUG PVC 14.9MM	25
3781 155	SEALING PLUG PVC 15.5MM	25
3781 190	SEALING PLUG PVC 19.0MM	25
3781 200	SEALING PLUG PVC 20.0MM	25
3781 225	SEALING PLUG PVC 22.5MM	15
3781 254	SEALING PLUG PVC 25.4MM	10
3781 320	SEALING PLUG PVC 32.0MM	10
3781 382	SEALING PLUG PVC 38.2MM	20
3781 515	SEALING PLUG PVC 51.5MM	10

Article No.	Article Description	QTY
9000 3781	ASSORTMENT SEALING PLUG PVC II	1
9000R 3781	TRAY SEALING PLUGS PVC II	1



Body Plugs in Assortment

- Thermoplastic rubber
- 10 mm–30 mm = 215 pieces

Contents:

Article No.	Article Description	Quantity
3783 10	BODY PLUG 10MM	25
3783 12	BODY PLUG 12MM	25
3783 14	BODY PLUG 14MM	25
3783 16	BODY PLUG 16MM	25
3783 18	BODY PLUG 18MM	25
3783 20	BODY PLUG 20MM	25
3783 22	BODY PLUG 22MM	20
3783 25	BODY PLUG 25MM	20
3783 30	BODY PLUG 30MM	25

Article No.	Article Description	QTY
9000 3783	ASSORTMENT BODY PLUGS	1
9000R 3783	TRAY BODY PLUGS	1



Protective Caps PVC in Assortment

- 7.11 mm – 32.64 mm = 145 pieces

Contents:

Article No.	Article Description	Quantity
3781 1 711	PVC PROTECTIVE CAP 7.11MM	20
3781 1 940	PVC PROTECTIVE CAP 9.40MM	20
3781 1 1067	PVC PROTECTIVE CAP 10.67MM	20
3781 1 1232	PVC PROTECTIVE CAP 12.32MM	20
3781 1 1359	PVC PROTECTIVE CAP 13.59MM	20
3781 1 1626	PVC PROTECTIVE CAP 16.26MM	10
3781 1 2019	PVC PROTECTIVE CAP 20.19MM	10
3781 1 2134	PVC PROTECTIVE CAP 21.34MM	10
3781 1 2565	PVC PROTECTIVE CAP 25.65MM	10
3781 1 3200	PVC PROTECTIVE CAP 32.64MM	5

Article No.	Article Description	QTY
9000 3781 1	ASSORTM.PVC PROTECTIVE CAPS	1
9000R 3781 1	TRAY PVC PROTECTIVE CAPS	1



Twist Drills DIN 338 HSS, Roll Forged Type N, Ass.

• Ø 1.0 – 10.5 mm (increments of 0.5 mm) = 135 pieces

Contents:

Article No.	Article Description	Quantity
5500 10	TWIST DRILL 338 ROLL F. 1.0	10
5500 15	TWIST DRILL 338 ROLL F. 1.5	10
5500 20	TWIST DRILL 338 ROLL F. 2.0	10
5500 25	TWIST DRILL 338 ROLL F. 2.5	10
5500 30	TWIST DRILL 338 ROLL F. 3.0	10
5500 35	TWIST DRILL 338 ROLL F. 3.5	10
5500 40	TWIST DRILL 338 ROLL F. 4.0	10
5500 45	TWIST DRILL 338 ROLL F. 4.5	10
5500 50	TWIST DRILL 338 ROLL F. 5.0	10
5500 55	TWIST DRILL 338 ROLL F. 5.5	5
5500 60	TWIST DRILL 338 ROLL F. 6.0	10
5500 65	TWIST DRILL 338 ROLL F. 6.5	5
5500 70	TWIST DRILL 338 ROLL F. 7.0	5
5500 75	TWIST DRILL 338 ROLL F. 7.5	5
5500 80	TWIST DRILL 338 ROLL F. 8.0	5
5500 85	TWIST DRILL 338 ROLL F. 8.5	2
5500 90	TWIST DRILL 338 ROLL F. 9.0	2
5500 95	TWIST DRILL 338 ROLL F. 9.5	2
5500 100	TWIST DRILL 338 ROLL F. 10.0	2
5500 105	TWIST DRILL 338 ROLL F. 10.5	2



Article No.	Article Description	QTY
9000 5500	ASS.TWIST DRILLS338 ROLL FORG.	1
9000R 5500	TRAY.TWIST DRILL338 ROLL FORG.	1

Twist Drill DIN 338 HSS, Polished Type N, Assortm.

- Content: 155 pieces
- Ø 1.0 - 10.5 mm
- 0.5 mm increase

Contents:

Article No.	Article Description	Quantity
5501 10	TWIST DRILL 338 GROUND 1.0	10
5501 15	TWIST DRILL 338 GROUND 1.5	10
5501 20	TWIST DRILL 338 GROUND 2.0	10
5501 25	TWIST DRILL 338 GROUND 2.5	10
5501 30	TWIST DRILL 338 GROUND 3.0	10
5501 35	TWIST DRILL 338 GROUND 3.5	10
5501 40	TWIST DRILL 338 GROUND 4.0	10
5501 45	TWIST DRILL 338 GROUND 4.5	10
5501 50	TWIST DRILL 338 GROUND 5.0	10
5501 55	TWIST DRILL 338 GROUND 5.5	10
5501 60	TWIST DRILL 338 GROUND 6.0	10
5501 65	TWIST DRILL 338 GROUND 6.5	5
5501 70	TWIST DRILL 338 GROUND 7.0	5
5501 75	TWIST DRILL 338 GROUND 7.5	5
5501 80	TWIST DRILL 338 GROUND 8.0	5
5501 85	TWIST DRILL 338 GROUND 8.5	5
5501 90	TWIST DRILL 338 GROUND 9.0	5
5501 95	TWIST DRILL 338 GROUND 9.5	5
5501 100	TWIST DRILL 338 GROUND 10.0	5
5501 105	TWIST DRILL 338 GROUND 10.5	5



Article No.	Article Description	QTY
9000 5501	ASSORT.TWIST DRILLS 338 POLISH	1
9000R 5501	TRAY.TWIST DRILL338 POLISHED	1

Twist Drill HSS-E, MULTI-INOX, Assortment **FÖRCH*******

- Contents: 62 pieces
- Placement: Ø 1.0 – 6 mm = 4 pieces
- Placement: Ø 6.5 – 10.5 mm = 2 pieces
- 0.5 mm increase

Contents:

Article No.	Article Description	Quantity
5506 5 10	TWIST DRILL 338 MULTI-INOX 1.0	4
5506 5 15	TWIST DRILL 338 MULTI-INOX 1.5	4
5506 5 20	TWIST DRILL 338 MULTI-INOX 2.0	4
5506 5 25	TWIST DRILL 338 MULTI-INOX 2.5	4
5506 5 30	TWIST DRILL 338 MULTI-INOX 3.0	4
5506 5 35	TWIST DRILL 338 MULTI-INOX 3.5	4
5506 5 40	TWIST DRILL 338 MULTI-INOX 4.0	4
5506 5 45	TWIST DRILL 338 MULTI-INOX 4.5	4
5506 5 50	TWIST DRILL 338 MULTI-INOX 5.0	4
5506 5 55	TWIST DRILL 338 MULTI-INOX 5.5	4
5506 5 60	TWIST DRILL 338 MULTI-INOX 6.0	4
5506 5 65	TWIST DRILL 338 MULTI-INOX 6.5	2
5506 5 70	TWIST DRILL 338 MULTI-INOX 7.0	2
5506 5 75	TWIST DRILL 338 MULTI-INOX 7.5	2
5506 5 80	TWIST DRILL 338 MULTI-INOX 8.0	2
5506 5 85	TWIST DRILL 338 MULTI-INOX 8.5	2
5506 5 90	TWIST DRILL 338 MULTI-INOX 9.0	2
5506 5 95	TWIST DRILL 338 MULTI-INOX 9.5	2
5506 5 100	TWIST DRILL 338 MULTI-INOX 10.0	2
5506 5 105	TWIST DR. 338 MULTI-INOX 10.5	2



Article No.	Article Description	QTY
9000 5506 5	ASSORT.TW.DR.338 MULTI INOX 5*	1
9000R 5506 5	TRAY.TW.DRILL338 MULTI-INOX 5*	1

Twist Drill HSS-E, STEAM, Assortment **FÖRCH*******

- Contents: 62 pieces
- Placement: Ø 1.0 – 6 mm = 4 pieces
- Placement: Ø 6.5 – 10.5 mm = 2 pieces
- 0.5 mm increase

Contents:

Article No.	Article Description	Quantity
5566 5 10	TW.DR.338 HSS-E STEAM 1.0 5*	4
5566 5 15	TW.DR.338 HSS-E STEAM 1.5 5*	4
5566 5 20	TW.DR.338 HSS-E STEAM 2.0 5*	4
5566 5 25	TW.DR.338 HSS-E STEAM 2.5 5*	4
5566 5 30	TW.DR.338 HSS-E STEAM 3.0 5*	4
5566 5 35	TW.DR.338 HSS-E STEAM 3.5 5*	4
5566 5 40	TW.DR.338 HSS-E STEAM 4.0 5*	4
5566 5 45	TW.DR.338 HSS-E STEAM 4.5 5*	4
5566 5 50	TW.DR.338 HSS-E STEAM 5.0 5*	4
5566 5 55	TW.DR.388 HSS-E STEAM 5.5 5*	4
5566 5 60	TW.DR.388 HSS-E STEAM 6.0 5*	4
5566 5 65	TW.DR.338 HSS-E STEAM 6.5 5*	2
5566 5 70	TW.DR.338 HSS-E STEAM 7.0 5*	2
5566 5 75	TW.DR.338 HSS-E STEAM 7.5 5*	2
5566 5 80	TW.DR.338 HSS-E STEAM 8.0 5*	2
5566 5 85	TW.DR.338 HSS-E STEAM 8.5 5*	2
5566 5 90	TW.DR.338 HSS-E STEAM 9.0 5*	2
5566 5 95	TW.DR.338 HSS-E STEAM 9.5 5*	2
5566 5 100	TW.DR.338 HSS-E STEAM 10.0 5*	2
5566 5 105	TW.DR.338 HSS-E STEAM 10.5 5*	2



Article No.	Article Description	QTY
9000 5566 5	ASSORT.TW.DR.338 HSSE STEAM 5*	1
9000R 5566 5	TRAY.TW.DRILL338 HSSE STEAM 5*	1

Twist Drill HSS-E, Multi TT, Assortment **FÖRCH*******

- Contents: 62 pieces
- Placement: Ø 1.0 – 6 mm = 4 pieces
- Placement: Ø 6.5 – 10.5 mm = 2 pieces
- 0.5 mm increase

Contents:

Article No.	Article Description	Quantity
5567 5 10	TW.DR.338HSS-E,MULTI-TT 1.0 5*	4
5567 5 15	TW.DR.338HSS-E,MULTI-TT 1.5 5*	4
5567 5 20	TW.DR.338HSS-E,MULTI-TT 2.0 5*	4
5567 5 25	TW.DR.338HSS-E,MULTI-TT 2.5 5*	4
5567 5 30	TW.DR.338HSS-E,MULTI-TT 3.0 5*	4
5567 5 35	TW.DR.338HSS-E,MULTI-TT 3.5 5*	4
5567 5 40	TW.DR.338HSS-E,MULTI-TT 4.0 5*	4
5567 5 45	TW.DR.338HSS-E,MULTI-TT 4.5 5*	4
5567 5 50	TW.DR.338HSS-E,MULTI-TT 5.0 5*	4
5567 5 55	TW.DR.338HSS-E,MULTI-TT 5.5 5*	4
5567 5 60	TW.DR.338HSS-E,MULTI-TT 6.0 5*	4
5567 5 65	TW.DR.338HSS-E,MULTI-TT 6.5 5*	2
5567 5 70	TW.DR.338HSS-E,MULTI-TT 7.0 5*	2
5567 5 75	TW.DR.338HSS-E,MULTI-TT 7.5 5*	2
5567 5 80	TW.DR.338HSS-E,MULTI-TT 8.0 5*	2
5567 5 85	TW.DR.338HSS-E,MULTI-TT 8.5 5*	2
5567 5 90	TW.DR.338HSS-E,MULTI-TT 9.0 5*	2
5567 5 95	TW.DR.338HSS-E,MULTI-TT 9.5 5*	2
5567 5 100	TW.DR.338HSSE,MULTI-TT 10.0 5*	2
5567 5 105	TW.DR.338HSSE,MULTI-TT 10.5 5*	2



Article No.	Article Description	QTY
9000 5567 5	ASSORT.TW.DR.338 MULTI TT 5*	1
9000R 5567 5	TRAY.TW.DRILL HSSE MULTI TT 5*	1

Mebux® Butt Connector Assort. 56 pcs. zinc-plated

- Thin-walled, solid steel insert, zinc-coated
- Coarse-pitch metric thread
- 56 pcs.
- With VAROsoft system insert Art. No. 9026 300

Your Advantage / Benefit

- Suitable for high constant load and frequent screwing and unscrewing
- Pressure-tight with water, oils, other liquids and gases
- Secure from unscrewing, no gluing required
- The existing collar means additional fixing is not required



Contents:

Article No.	Article Description	Quantity
5572 5 08 1	INSERTION TOOL M5X0.8	1
5572 5 08 2	TAP M 5X0.8	1
5572 5 08 3	DRILL BIT M 5X0.8	1
5572 5 08 4	FIT MILLING CUTTER M 5X0.8	1
5572 5 08 76	PCK(5)THR.BUSH. M5X0.8X7.6 ZN	1
5572 5 08 100	PCK(5)THR.BUSH. M5X0.8X10.0 ZN	1
5572 6 10 1	INSERTION TOOLS M6X1.0	1
5572 6 10 2	TAP M 6X1.0	1
5572 6 10 3	DRILL BIT M 6X1.0	1
5572 6 10 4	FIT MILLING CUTTER M 6X1.0	1
5572 6 10 94	PACK(5)THR.BUSH M6X1.0X9.4 ZN	1
5572 6 10 120	PCK(5)THR.BUSH M6X1.0X12.0 ZN	1
5572 8 125 1	INSERTION TOOL M 8X1.25	1
5572 8 125 2	TAP M 8X1.25	1
5572 8 125 3	DRILL BIT M 8X1.25	1
5572 8 125 4	FIT MILLING CUTTER M 8X1.25	1
5572 8 125 117	PCK(5)THR.BU. M8X1.25X11.7 ZN	1
5572 8 125 162	PCK(5)THR.BU. M8X1.25X16.2 ZN	1
5572 10 3	DRILL BIT M10X1.0/1.25/1.5	1
5572 10 4	FIT MILL.CUTT.M10X1.0/1.25/1.5	1
5572 10 15 1	INSERTION TOOL M10X1.5	1
5572 10 15 2	TAP M10X1.5	1
5572 10 15 140	PCK(5)THR.BU.M10X1.5X14.0 ZN	1
5572 10 15 200	PCK(5)THR.BU.M10X1.5X20.0 ZN	1

Article No.	Article Description	QTY
9000 5572	ASSORT.MEBUX STEEL ZN 56-PIECE	1
9000R 5572	INLAY ASS.MEBUX STEEL ZN 56PCE	1

Application

- Manufacture of threaded joints and renewal of damaged or stripped threads
- For aluminium, brass, steel and cast materials

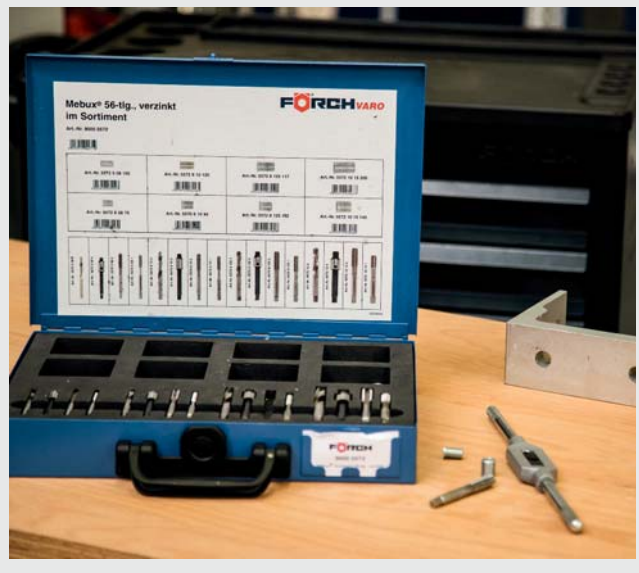

Related Products

- Thread-cutting Fluid
Art. No. 6580 5851



- Tap Wrench
Art. No. 5560 2



Plastic Rivets in Assortment

- 81 pieces
- For the fixing of inner linings, inner mud guards, dashboards etc.
- Usable for different vehicles such as BMW, Chrysler, Saab, Jaguar, Ford, etc.

Article No.	Article Description	QTY
9000 3040 3	ASSORTMENT PLASTIC RIVETS	1
9000R 3040 3	TRAY FOR PLASTIC RIVETS	1

Contents:

- 20x Art. No. 3040 4001: Plastic rivets 5.0 × 17.2 mm
- 20x Art. No. 3040 4002: Plastic rivets 5.0 × 15.8 mm
- 20x Art. No. 3040 4003: Plastic rivets 6.3 × 25.2 mm
- 20v Art. No. 3040 4004: Plastic rivets 6.8 × 17.2 mm
- 1x Art. No. 2722 20 2: Rivet gun for plastic rivets



Fixing Parts, 140 Pieces in Assortment

Contents:

Article No.	Article Description	Quantity
3040 1003	INNER LINING CLIP 1003	10
3040 1004	ROOF STRIP CLIP 1004	10
3040 1005	MOULDING CLIP 1005	10
3040 1006	GROMMET CLOSED 8.8X11.4	10
3040 1007	CABLE TIE WITH FOOT 140X4.5MM	10
3040 3001	EXP.RIVET PLAST. 7.9X12.0 B16	10
3040 3002	EXP.RIVET PLAST.5.8X11.4 B10	10
3040 3003	EXP.RIVET PLAST.5.5X11.0 B16	10
3040 3004	EXP.RIV.PLAST.S.5.0X15.0 B10	10
3040 3005	EXP.RIVET PLAST.13.0X17.4 B20	10
3040 3006	EXP.RIV.PLAST.L.5.0X15.0 B10	10
3040 3007	EXP.RIV.PLAST.7.8X11.0 B12.3	10
3040 3009	EXP.RIVET PLAST.8.0X15.0 B13	10
3040 3011	EXP.RIV.W.CAP PLAST.6.5X17 B20	10

Article No.	Article Description	QTY
9000 3040 1	ASSORT.FIXING PARTS 140-PIECE	1
9000R 3040 1	TRAY FIXING PARTS 140-PIECE	1



Fixing Parts, 250 Pieces in Assortment

Contents:

Article No.	Article Description	Quantity
3040 3001	EXP.RIVET PLAST. 7.9X12.0 B16	25
3040 3002	EXP.RIVET PLAST.5.8X11.4 B10	25
3040 3003	EXP.RIVET PLAST.5.5X11.0 B16	25
3040 3004	EXP.RIV.PLAST.S.5.0X15.0 B10	25
3040 3005	EXP.RIVET PLAST.13.0X17.4 B20	25
3040 3006	EXP.RIV.PLAST.L.5.0X15.0 B10	25
3040 3007	EXP.RIV.PLAST.7.8X11.0 B12.3	25
3040 3009	EXP.RIVET PLAST.8.0X15.0 B13	25
3040 3011	EXP.RIV.W.CAP PLAST.6.5X17 B20	25
3040 3013	PLST.SPREAD NUT 8.0X8.0 3013	25

Article No.	Article Description	QTY
9000 3040 2	ASSORTM.FIXING PARTS 250-PIECE	1
9000R 3040 2	TRAY FIXING PARTS 250-PIECE	1



Impact Sockets 6-edged 1/2“ Short in Assortment

• 13 pieces

Contents:

Article No.	Article Description	Quantity
4570 12 10	1/2" KRAFT SOCK.WR.INS.SH.SW10	1
4570 12 12	1/2" KRAFT SOCK.WR.INS.SH.SW12	1
4570 12 13	1/2" KRAFT SOCK.WR.INS.SH.SW13	1
4570 12 14	1/2" KRAFT SOCK.WR.INS.SH.SW14	1
4570 12 15	1/2" KRAFT SOCK.WR.INS.SH.SW15	1
4570 12 16	1/2" KRAFT SOCK.WR.INS.SH.SW16	1
4570 12 17	1/2" KRAFT SOCK.WR.INS.SH.SW17	1
4570 12 18	1/2" KRAFT SOCK.WR.INS.SH.SW18	1
4570 12 19	1/2" KRAFT SOCK.WR.INS.SH.SW19	1
4570 12 21	1/2" KRAFT SOCK.WR.INS.SH.SW21	1
4570 12 22	1/2" KRAFT SOCK.WR.INS.SH.SW22	1
4570 12 24	1/2" KRAFT SOCK.WR.INS.SH.SW24	1
4570 12 27	1/2" KRAFT SOCK.WR.INS.SH.SW27	1



Article No.	Article Description	QTY
9000 4570 12	1/2"KRAFT SOCK.WR.INS.SHORT	1
9000R 4570 12	1/2"INLETT KRAFT S.WR.IN.SHORT	1

Impact Sockets 6-edged 3/4“ Short in Assortment

• 11 pieces

Contents:

Article No.	Article Description	Quantity
4570 34 17	3/4"KRAFT SOCK.W.IN.SHORT SW17	1
4570 34 19	3/4"KRAFT SOCK.W.IN.SHORT SW19	1
4570 34 22	3/4"KRAFT SOCK.W.IN.SHORT SW22	1
4570 34 24	3/4"KRAFT SOCK.W.IN.SHORT SW24	1
4570 34 27	3/4"KRAFT SOCK.W.IN.SHORT SW27	1
4570 34 29	3/4"KRAFT SOCK.W.IN.SHORT SW29	1
4570 34 30	3/4"KRAFT SOCK.W.IN.SHORT SW30	1
4570 34 32	3/4"KRAFT SOCK.W.IN.SHORT SW32	1
4570 34 33	3/4"KRAFT SOCK.W.IN.SHORT SW33	1
4570 34 36	3/4"KRAFT SOCK.W.IN.SHORT SW36	1
4570 34 38	3/4"KRAFT SOCK.W.IN.SHORT SW38	1



Article No.	Article Description	QTY
9000 4570 34	3/4"KRAFT SOCK.WR.INS. SHORT	1
9000R 4570 34	3/4"INLETT KRAFT S.WR.IN.SHORT	1

Impact Sockets 6-edged 1/2“ Long in Assortment

• 7 pieces

Contents:

Article No.	Article Description	Quantity
4571 12 13	1/2"KRAFT SOCK.WR.IN.LONG.SW13	1
4571 12 17	1/2"KRAFT SOCK.WR.IN.LONG SW17	1
4571 12 19	1/2"KRAFT SOCK.WR.IN.LONG SW19	1
4571 12 21	1/2"KRAFT SOCK.WR.IN.LONG SW21	1
4571 12 22	1/2"KRAFT SOCK.WR.IN.LONG SW22	1
4571 12 24	1/2"KRAFT SOCK.WR.IN.LONG SW24	1
4571 12 27	1/2"KRAFT SOCK.WR.IN.LONG SW27	1

Article No.	Article Description	QTY
9000 4571 12	1/2"KRAFT SOCK.WR.INS LONG	1
9000R 4571 12	1/2"INLETT KRAFT S.WR.IN. LONG	1



Impact Sockets 6-edged 3/4“ Long in Assortment

• 8 pieces

Contents:

Article No.	Article Description	Quantity
4571 34 22	3/4"KRAFT SOCK.W.INS.LONG SW22	1
4571 34 24	3/4"KRAFT SOCK.W.INS.LONG SW24	1
4571 34 27	3/4"KRAFT SOCK.W.INS.LONG SW27	1
4571 34 29	3/4"KRAFT SOCK.W.INS.LONG SW29	1
4571 34 30	3/4"KRAFT SOCK.W.INS.LONG SW30	1
4571 34 32	3/4"KRAFT SOCK.W.INS.LONG SW32	1
4571 34 33	3/4"KRAFT SOCK.W.INS.LONG SW33	1
4571 34 36	3/4"KRAFT SOCK.W.INS.LONG SW36	1

Article No.	Article Description	QTY
9000 4571 34	3/4"KRAFT SOCK.WR.INS LONG	1
9000R 4571 34	3/4"INLETT KRAFT S.WR.IN. LONG	1



Top Plate And Hooking-In System

- For fixing of winding systems, hooks, tools or similar.



Single Perforated Panels

- Colour: Blue
- Boring 10 × 10 mm quadratic

Article No.	Article Description	QTY
9101 4550	PERFORATED PANEL 450X500MM	1
9101 45100	PERFORATED PANEL 450X1000MM	1
9101 45150	PERFORATED PANEL 450X1500MM	1
9101 45200	PERFORATED PANEL 450X2000MM	1

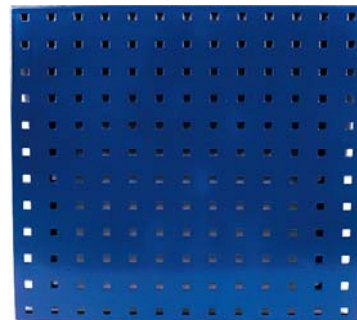

Single Hook for Perforated Panels

- 45° angled
- Wire Ø: 5 mm
- Plastic screw M4 × 6
- Alternatively metal screw Art. No. 1201 4 6

Article No.	Article Description	QTY
9101 150	HOOK 45° ANGL.50MM F.PERF.PAN.	1
9101 1100	HOOK45° ANGL.100MM F.PERF.PAN.	1
9101 1150	HOOK45° ANGL.150MM F.PERF.PAN.	1
9101 1200	HOOK45° ANGL.200MM F.PERF.PAN.	1



Double Hook for Perforated Panels

- 45° angled
- Wire Ø: 5 mm
- Plastic screw M4 × 6
- Alternatively metal screw Art. No. 1201 4 6

Article No.	Article Description	QTY
9101 235	HOOK DOUBLE35X35MM F.PERF.PAN.	1
9101 250	HOOK DOUBLE50X35MM F.PERF.PAN.	1
9101 275	HOOK DOUBLE75X35MM F.PERF.PAN.	1
9101 2150	HOOK DOUBLE150X35MM F.PERF.PA.	1

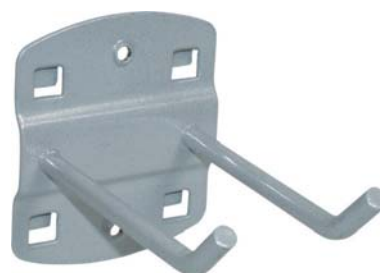

(Length × fastener distance)

Hook for Perforated Panels

- Wire Ø: 5 mm
Plastic screw M4 × 6
- Alternatively metal screw Art. No. 1201 4 6

Article No.	Article Description	QTY
9101 335	HOOK90° ANGLED35MM F.PERF.PAN.	1
9101 375	HOOK90° ANGLED75MM F.PERF.PAN.	1
9101 3125	HOOK90° ANGL.125MM F.PERF.PAN.	1



Hook for Perforated Panels

- Plastic screw M4 × 6
- Alternatively metal screw Art. No. 1201 4 6

Article No.	Article Description	QTY
9101 46	HOOK CLIP 6MM	1
9101 410	HOOK CLIP 10MM	1
9101 413	HOOK CLIP 13MM	1
9101 416	HOOK CLIP 16MM	1
9101 419	HOOK CLIP 19MM	1



Hose / Tube Holder for Perforated Panels

- Plastic screw M4 × 6
- Alternatively metal screw Art. No. 1201 4 6

Article No.	Article Description	QTY
9101 660	HOSE/TUBE HOLDER 60MM	1
9101 6100	HOSE/TUBE HOLDER 100MM	1



Pliers Holder for Perforated Panels

- Plastic screw M4 × 6
Alternatively metal screw Art. No. 1201 4 6

Article No.	Article Description	QTY
9101 735	PLIERS HOLDER 20X35MM	1
9101 755	PLIERS HOLDER 20X55MM	1
9101 775	PLIERS HOLDER 20X75MM	1

(length × width)



Angular Hook

- Plastic screw M4 × 6
- Alternatively metal screw Art. No. 1201 4 6
- Length: 40 mm

Article No.	Article Description	QTY
9101 840	ANGULAR HOOK 40MM	1



Machine Holder

- Plastic screw M4 × 6
- Alternatively metal screw Art. No. 1201 4 6
- Angles: 40°, 60°, 80°

Article No.	Article Description	QTY
9101 940	MACHINE HOLDER 40°	1
9101 960	MACHINE HOLDER 60°	1
9101 980	MACHINE HOLDER 80°	1



Key Holder for 8 Keys

- Plastic screw M4 × 6
- Alternatively metal screw Art. No. 1201 4 6

Article No.	Article Description	QTY
9101 8	KEY HOLDER 8-FOLD	1



Screw Driver Holder

- Plastic screw M4 x 6
- Alternatively metal screw Art. No. 1201 4 6
- For 6 or 12 screw drivers

Article No.	Article Description	QTY
9101 6	SCREW DRIVER HOLDER 6-FOLD	1
9101 12	SCREW DRIVER HOLDER 12-FOLD	1

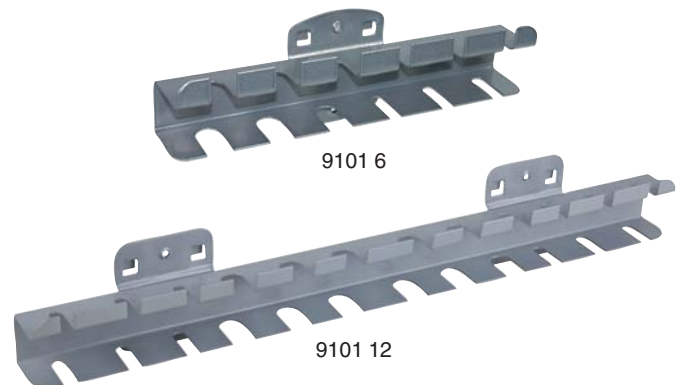

Drill Bit Holder

- Plastic screw M4 × 6
- Alternatively metal screw Art. No. 1201 4 6
- Art. No. 9101 14:**
- Drill intake Ø mm each 1x: 3.4 / 3.8 / 4.2 / 4.8 / 5.2 / 5.8 / 6.2 / 6.8 / 8.2 / 8.8 / 9.8 / 11.2 / 12.2 / 13.2
- Art. No. 9101 28:**
- Drill intake Ø mm each 2x: 3.4 / 3.8 / 4.2 / 4.8 / 5.2 / 5.8 / 6.2 / 6.8 / 8.2 / 8.8 / 9.8 / 11.2 / 12.2 / 13.2

Article No.	Article Description	QTY
9101 14	DRILL BIT HOLDER 14-FOLD	1
9101 28	DRILL BIT HOLDER 28-FOLD	1

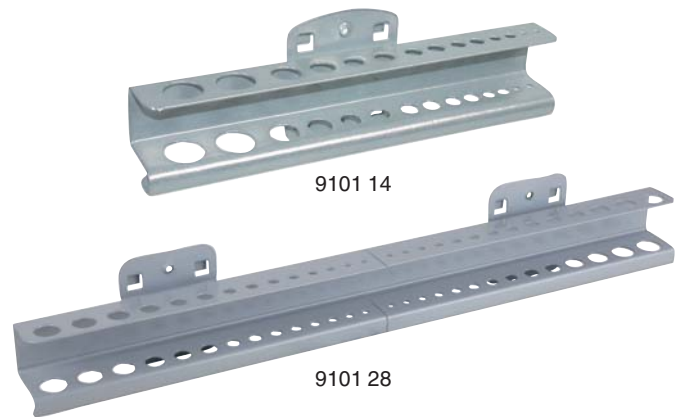

Tray

- Plastic screw M4 × 6
- Alternatively metal screw Art. No. 1201 4 6

Article No.	Article Description	QTY
9101 13	TRAY 350X125MM	1



Hook Assortment

- **49-piece hook assortment**
- For use on perforated panels in workshops and warehouses
- Helps keep everything organised and stores tools safely within easy reach
- 5 – 10 mm
- Plastic screw M4 × 6
- Alternative metal screw Art. No. 1201 4 6

Article No.	Article Description	QTY
9101 49	VARO-ASSORTMENT HOOKS 49PCS	1

Contents:

- 1x Art. No. 9101 6 60, 9101 6 100, 9101 7 35, 9101 7 55, 9101 7 75, 9101 9 40, 9101 9 60, 9101 6, 9101 12, 9101 2 35, 9101 2 50, 9101 2 75
- 2x Art. No. 9101 9 80, 9101 1 150, 9101 1 200, 9101 3 125, 9101 4 13, 9101 4 19, 9101 8 40
- 3x Art. No. 9101 1 100, 9101 3 35, 9101 3 75, 9101 4 6, 9101 4 10, 9101 4 13
- 5x Art. No. 9101 1 50

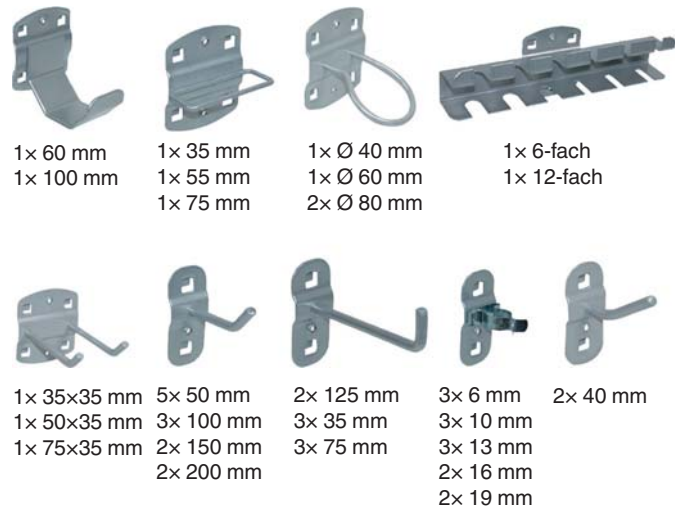

Storing Racks

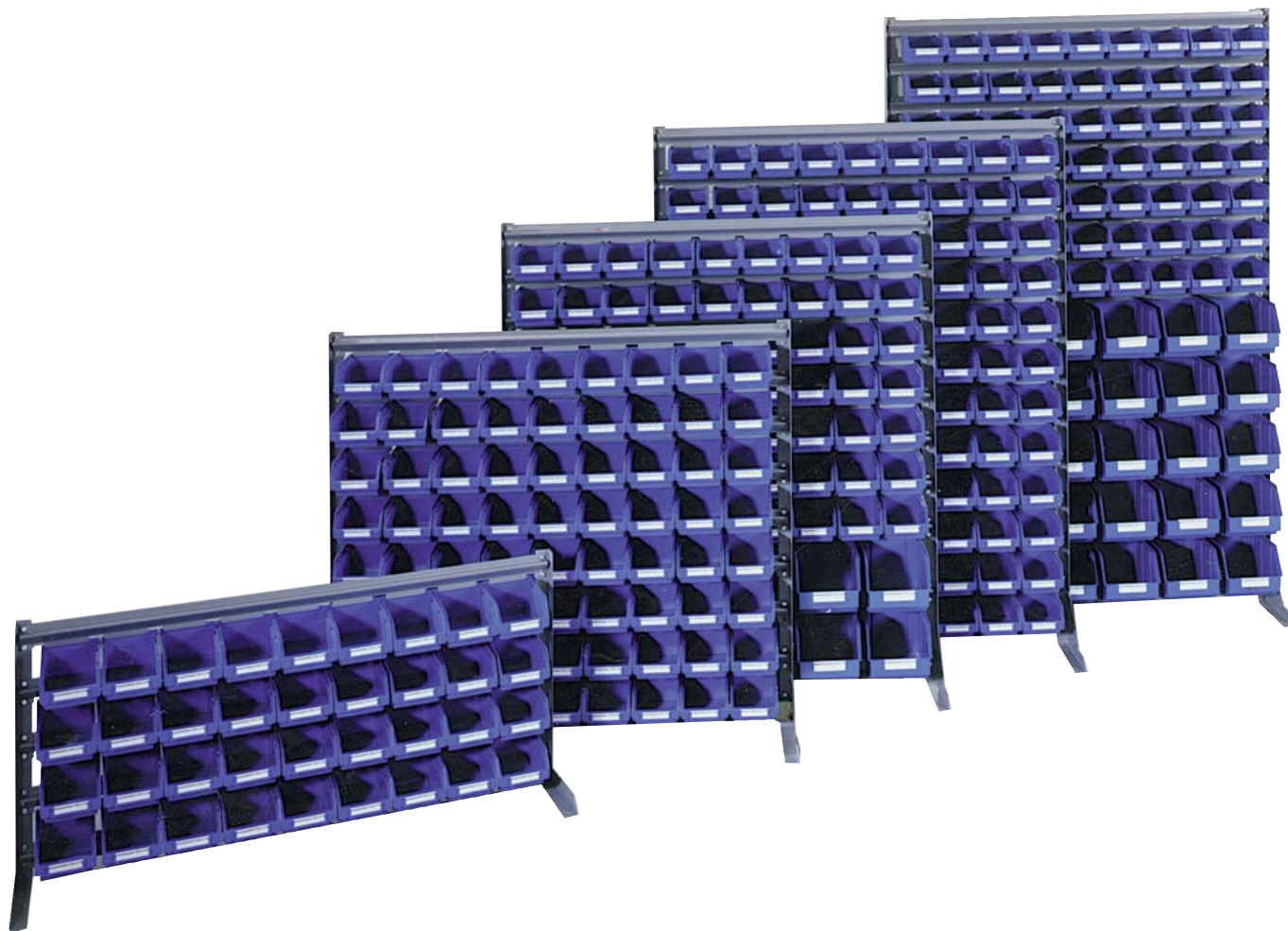

- Racks without boxes can be assembled at buyer's option with boxes of different colours

Article No.	Article Description	QTY
9050 36	RACK WITH BLUE BOXES 36	1
9050 72	RACK WITH BLUE BOXES 72	1
9050 108	RACK WITH BLUE BOXES 108	1
9050 63 12	RACK WITH BLUE BOXES 63/12	1
9050 63 30	RACK WITH BLUE BOXES 63/30	1
9060 36	RACK WITHOUT BOXES 36	1
9060 72	RACK WITHOUT BOXES 72	1
9060 108	RACK WITHOUT BOXES 108	1
9060 63 12	RACK WITHOUT BOXES 63/12	1
9060 63 30	RACK WITHOUT BOXES 63/30	1

Technical Data			
Art. No.	Size W x H mm	For box size	Number of boxes
9050 36	1,020 x 480	2	36
9050 72	1,020 x 900	2	72
9050 108	1,020 x 1.320	2	108
9050 63 12	1,020 x 1.100	2/3	63/12
9050 63 30	1,020 x 1.580	2/3	63/30
9060 36	1,020 x 480	2	36
9060 72	1,020 x 900	2	72
9060 108	1,020 x 1.320	2	108
9060 63 12	1,020 x 1.100	2/3	63/12
9060 63 30	1,020 x 1.580	2/3	63/30

(with and accordingly for number of boxes)

Assembly Bar

- Made of zinc-coated sheet steel
- Without boxes



Article No.	Article Description	QTY
9061 1 9	ASSEMBLY BAR F.BOXES SI.1/9 ST	1
9061 2 9	ASSEMBLY BAR F.BOXES SI.2/9 ST	1
9061 3 6	ASSEMBLY BAR F.BOXES SI.3/6 ST	1
9061 4 4	ASSEMBLY BAR F.BOXES SI.4/4 ST	1

Technical Data			
Art. No.	Size L x H mm	for Size of boxes	Number of boxes
9061 19	980 x 65	1	9
9061 29	980 x 95	2	9
9061 36	980 x 144	3	6
9061 44	980 x 166	4	4

(Box size/Number of boxes)

Storage Boxes Size 1

- Made of shock-resistant polystyrene
- Stackable
- Dimensions (L x W x H): 85 / 65 x 100 x 50 mm

Article No.	Article Description	QTY
9055 1	VARO STORAGE BOX BLUE SIZE 1	e 92
9055 2	VARO STORAGE BOX RED SIZE 1	e 30
9055 3	VARO STORAGE BOX GREEN SIZE 1	1
9055 4	VARO STORAGE BOX YELLOW SIZE 1	e 30
9055 5	VARO STORAGE BOX GREY SIZE 1	e 92



Storage Boxes Size 2

- Made of shock-resistant polystyrene
- Stackable
- Dimensions (L x W x H): 160 / 140 x 100 x 75 mm

Article No.	Article Description	QTY
9056 1	VARO STORAGE BOX BLUE SIZE 2	e 72
9056 2	VARO STORAGE BOX RED SIZE 2	e 72
9056 3	VARO STORAGE BOX GREEN SIZE 2	e 72
9056 4	VARO STORAGE BOX YELLOW SIZE 2	e 72
9056 5	VARO STORAGE BOX GREY SIZE 2	e 72



Storage Boxes Size 3

- Made of shock-resistant polystyrene
- Stackable
- Dimensions (L x W x H): 230 / 200 x 145 x 125 mm

Article No.	Article Description	QTY
9057 1	VARO STORAGE BOX GR.3 BLUE	e 30
9057 2	VARO STORAGE BOX RED SIZE 3	e 30
9057 3	VARO STORAGE BOX GREEN SIZE 3	e 30
9057 4	VARO STORAGE BOX YELLOW SIZE 3	e 30
9057 5	VARO STORAGE BOX GREY SIZE 3	e 30



Storage Boxes Size 4

- Made of shock-resistant polystyrene
- Stackable
- Dimensions (L x W x H): 335 / 300 x 200 x 150 mm

Article No.	Article Description	QTY
9058 1	VARO STORAGE BOX BLUE SIZE 4	e 12
9058 2	VARO STORAGE BOX RED SIZE 4	e 12
9058 3	VARO STORAGE BOX GREEN SIZE 4	e 12
9058 4	VARO STORAGE BOX YELLOW SIZE 4	e 12
9058 5	VARO STORAGE BOX GREY SIZE 4	e 12



Storage Boxes Size 5

- Made of shock-resistant polystyrene
- Stackable
- Dimensions (L x W x H): 490 / 425 x 310 x 180 mm

Article No.	Article Description	QTY
9059 1	VARO STORAGE BOX BLUE SIZE 5	e 8
9059 2	VARO STORAGE BOX RED SIZE 5	e 8
9059 3	VARO STORAGE BOX GREEN SIZE 5	e 8
9059 4	VARO STORAGE BOX YELLOW SIZE 5	e 8
9059 5	VARO STORAGE BOX GREY SIZE 5	e 8



Storage Boxes Blue 186 mm

- Separation wall width: 186 mm
- Colour: blue
- Art. No. 9054 300 186:**
- Dimensions (L x W x H): 300 x 186 x 83 mm
- Art. No. 9054 400 186:**
- Dimensions (L x W x H): 400 x 186 x 83 mm

Article No.	Article Description	QTY
9054 300 186	STORAGE BOX RK 300/186 BLUE	e 8
9054 400 186	SHELF-BOX RK 400/186 BLUE	e 8
9054 186	DIVIDING WALL RK/T 186	e 25



Storage Boxes Blue 93 mm

- Separation wall width: 93 mm
- Colour: blue
- Art. No. 9054 300 93:**
- Dimensions (L x W x H): 300 x 93 x 90 mm
- Art. No. 9054 400 93:**
- Dimensions (L x W x H): 400 x 93 x 90 mm

Article No.	Article Description	QTY
9054 300 93	STORAGE BOX RK 300/93 BLUE	e 16
9054 400 93	SHELF-BOX RK 400/93 BLUE	e 16
9054 93	DIVIDING WALL RK/T 93	e 25



Storage Box Size D Blue

- Dimensions (L x W x H): 270 x 87 x 55 mm
- Separation wall width: 87 mm
- Colour: blue

Article No.	Article Description	QTY
9095 1	STORAGE BOX SI.D BLUE	1
9095 2	PARTITION WALL SI.DT BLUE	e 50

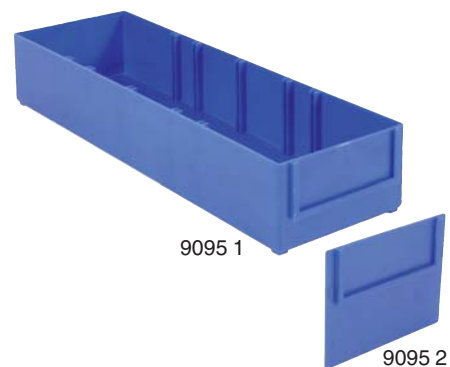

Drawer Box Grey

- Dimensions (L x W x H): 321 x 105 x 45 mm
- Colour: grey

Article No.	Article Description	QTY
9100 20	DRAWER BOX GREY	1



System Racks

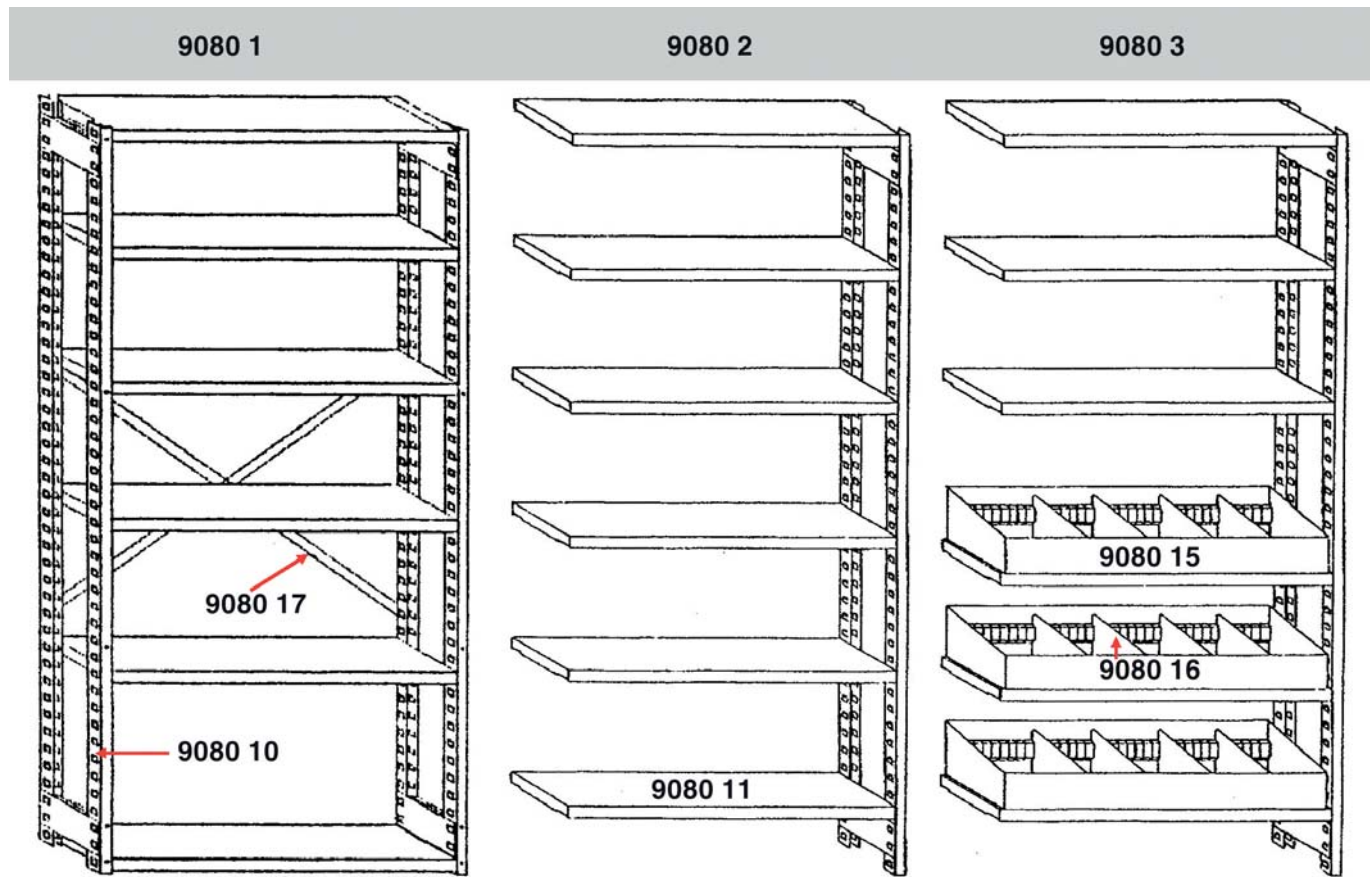

- Blue painted frame, zinc-plated shelf
 - We recommend a diagonal composition after every third add-on shelf
 - Load capacity per shelf: 100 kg substrate-distributed
- Art. No. 9080 1:**
- Consists of:
2x rack frames, 1x diagonal composition, 6x shelves
- Art. No. 9080 2:**
- Consists of:
1x rack frame, 6x shelves
- Art. No. 9080 3:**
- Consists of:
1x rack frame, 3x shelves, 3x trays for bulk material, 12x partition walls

Article No.	Article Description	QTY
9080 1	BASIC RACK 2200-300 TYPE A	1
9080 2	EXTENSION RACK 2200-300 TYPE B	1
9080 3	EXTENSION RACK 2200-300 TYPE C	1
9080 10	RACK FRAME 2200X300 MM	1
9080 11	LOWER SHELF 970X300 MM	1
9080 15	STORAGE TRAY 970X300MM	1
9080 16	PARTITION WALL 300X120/75MM	1
9080 17	DIAGONAL ASSEMBLY 970MM	1

Technical Data	
Art. No.	Dimensions H x W x D mm
9080 1	2,200 x 990 x 300
9080 2	2,200 x 990 x 300
9080 3	2,200 x 990 x 300
9080 10	2,200 x 300
9080 11	970 x 300
9080 15	970 x 300
9080 16	300 x 120/75
9080 17	1,280

VARO Rack 3 Towers Equipped

- Consists of 3 equipped VARO racks
- Rack consists of 12,521 parts: screws, nuts, washers, spring washers, blind rivets, clamps, sealing rings, split pins, workshop chemical products, cable ties, heat shrink tubings, fuses
- Can be extended easily with VARO rack and storage system
- Dimensions (H x W x D): 2.160 x 2.352 x 400 mm

Article No.	Article Description	QTY
9100P 900	VARO-RACK 3 TOWERS EQUIPPED	1

Contents:

- AGR 1011: Hex head screws DIN 933 8.8, zinc-plated
100x: M5 x 16/M5 x 20/M6 x 16/M6 x 20/M6 x 30/M6 x 40/M6 x 50/M8 x 16/M8 x 20/M8 x 25/M8 x 30/M8 x 40/M8 x 50/M8 x 70/M10 x 20/M10 x 25/M10 x 30/M10 x 40/M10 x 50/M10 x 70/M12 x 25/M12 x 30/M12 x 40/M12 x 50/M14 x 30
50x: M16 x 30
- AGR 2001: Hex nuts DIN 934-8, zinc-plated
100x: M5/M6/M8/M10
50x: M12/M14/M16
- AGR 2101: Hex stop nuts DIN 985-8, zinc-plated
100x: M5/M6/M8/M10
50x: M12/M12 x 1.5/M14/M14 x 1.5/M16/M16 x 1.5
- AGR 2301: Washers DIN 125 Form A, zinc-plated
100x: for M5/M6/M8/M10/M12/M14/M16
- AGR 2331: Body washers, zinc-plated
100x: for M5 x 15/M6 x 20/M8 x 25/M10 x 30/M12 x 30
- AGR 2501: Spring lock washers DIN 127, zinc-plated
300x: for M5/M6
100x: for M8/M10/M12/M14/M16
- AGR 2710: Blind rivets with flat head AL/ST
100x: 4 x 10/4 x 12/5 x 12/5 x 16/5 x 20
- AGR 3200: Hose clamps W2 TORRO
50x: SW6 8 – 12/SW6 10 – 16/SW7 12 – 22/SW7 16 – 27/SW7 20 – 32/SW7 25 – 40
25x: SW7 32 – 50/SW7 40 – 60/SW7 50 – 70/SW7 60 – 80
- Art. No. 3750B 35 145: Cable ties in box
350x Art. No. 3750 35 145: Cable ties black 3.5 x 145 mm
- Art. No. 3750B 47 195: Cable ties in box
250x Art. No. 3750 47 195: Cable ties black 4.7 x 195 mm
- Art. No. 3750B 47 285: Cable ties in box
200x Art. No. 3750 47 285: Cable ties black 4.7 x 285 mm
- 2x Art. No. 6100 0182: Cockpit Care P300, 300 ml
- 2x Art. No. 6100 1600: Intensive Windscreen Clean R530, 400 ml
- 2x Art. No. 6100 1660: Active Plus 5 Foam Cleaner R560, 600 ml
- 15x Art. No. 6110 0914: Brake Cleaner Premium R510, 600 ml
- 1x Art. No. 6160 0152: Screenwash Anti-freeze R537, 5 l
- 2x Art. No. 6200 0505: Rust Stop Primer Premium Dark Red L239, 400 ml
- 2x Art. No. 6200 2505: Quick Drying Primer Light Grey L238, 400 ml
- 2x Art. No. 6210 2500: Paint Black Mat L213, 400 ml
- 2x Art. No. 6210 2502: Paint Black High Gloss L215, 400 ml
- 2x Art. No. 6500 5580: Heavy Duty PTFE Grease S404, 500 ml
- 2x Art. No. 6520 5575: High Performance PTFE Oil S408, 500 ml
- 2x Art. No. 6530 1500: Silicone Spray S420, 500 ml
- 2x Art. No. 6610 6001: Stone Guard Black L260, 500 ml
- 2x Art. No. 6700 0048: Black Magic S411, 400 ml
- 1x Art. No. 6760 7500: Brake Fluid DOT 4, 5 l
- Art. No. 9000R 1318: Self-tapping screws PH flat head sim. to DIN 7981, black in tray, contents: 1,650 pieces
100x AGR 1318: 3.5 x 9.5/3.5 x 13/3.5 x 16/3.5 x 19/3.9 x 13/3.9 x 16/3.9 x 19/4.2 x 9.5/4.2 x 13/4.2 x 16/4.2 x 19/4.2 x 22/4.8 x 13/4.8 x 16/4.8 x 19
50x AGR 1318: 3.9 x 22/4.2 x 25/4.8 x 25
- Art. No. 9000R 2600: Sealing rings 7603 A, copper in tray, contents: 1,195 pieces
- 100x AGR 2600: 6 x 10 x 1.0/6 x 12 x 1.0/8 x 12 x 1.0/8 x 14 x 1.0/10 x 14 x 1.0/10 x 16 x 1.0/12 x 16 x 1.5/12 x 18 x 1.5/14 x 18 x 1.5/14 x 20 x 1.5
50x AGR 2600: 16 x 20 x 1.5
25x AGR 2600: 16 x 22 x 1.5/18 x 24 x 1.5/20 x 26 x 1.5/22 x 27 x 1.5/26 x 32 x 2.0
10x AGR 2600: 30 x 36 x 2.0/32 x 38 x 2.0
- Art. No. 9000R 2801: Split pins DIN 94, zinc-plated in tray, contents: 1,325 pieces
200x AGR 2801: 1 x 20/1.6 x 32/2 x 32
100x AGR 2801: 2.5 x 32/2.5 x 40/3.2 x 32/3.2 x 50/3.5 x 40/4 x 40
50x AGR 2801: 4 x 63/5 x 50
25x AGR 2801: 6.3 x 63
- Art. No. 9000R 3731: Heat shrink tubing SR 2:1 in tray, contents: 120 pieces
25x AGR 3731: 2.4/3.2
20x AGR 3731: 4.8
15x AGR 3731: 6.4/9.5
10x AGR 3731: 12.7
5x AGR 3731: 19.0/25.4
- Art. No. 9000R 3810: Fuses standard in tray, contents: 257 pieces
1x Art. No. 3810 1: Fuse removal tool
25x AGR 3810: 2A/3A/5A/7.5A/10A/15A/20A/25A/30A/40A
5x Art. No. 3815 3810: Fuses standard holder with cutter
2x Art. No. 3815 3810 2: Blade fuse holder with connector 6.3 mm flat plug tab
- 1x Art. No. 9026 8: Tray for assortment box, 8-fold
- 1x Art. No. 9026 10: Tray for assortment box, 10-fold
- 1x Art. No. 9026 12: Tray for assortment box, 12-fold
- 1x Art. No. 9026 18: Tray for assortment box, 18-fold
- 72x Art. No. 9056 1: Box size 2, blue
- 45x Art. No. 9057 1: Box size 3, blue
- 3x Art. No. 9100 0: VARO base and perforated panel
- 1x Art. No. 9100 1: VARO drawer unit 1 with 3 drawers
- 3x Art. No. 9100 2: VARO box unit 2 for storage boxes size 2
- 3x Art. No. 9100 3: VARO box unit 3 for storage boxes size 3
- 1x Art. No. 9100 44: VARO chemical unit 4, 2-fold
- 1x Art. No. 9100 7: VARO universal base 7



VARO DIN Rack

- With all common sizes and types
- Ideal overview and inventory control
- Robust and extendable version
- Rack consisting of approx. 8,000 DIN and standard parts; 63 boxes size 2; 4 VARO rack units
- Dimensions (H x W x D) (assembled): 2,160 x 785 x 400 mm

Article No.	Article Description	QTY
9052 63	VARO DIN PARTS RACK ASSEMBLED	1

Contents:

DIN 933 zn:

- each 200 pcs. 5 x 16 / 5 x 20 / 6 x 16 / 6 x 20
- each 100 pcs. 5 x 25 / 6 x 25 / 6 x 30 / 8 x 20 / 8 x 25 / 8 x 30 / 8 x 40 / 10 x 20
- each 50 pcs. 10 x 30 / 10 x 40

DIN 125 zn:

- each 200 pcs. 5 / 6 / 8
- each 100 pcs. 10 / 12

Body washers zn:

- each 200 pcs. 5 x 15 / 5 x 20 / 6 x 20 / 6 x 25 / 8 x 20
- each 100 pcs. 8 x 30 / 10 x 25 / 10 x 30 / 12 x 30

DIN 127 zn:

- each 200 pcs. 5 / 6 / 8
- each 100 pcs. 10 / 12

DIN 934 zn:

- each 200 pcs. M 5 / M 6 / M 8
- each 100 pcs. M 10 / M 12

DIN 985 zn:

- each 100 pcs. M 5 / M 6 / M 8 / M 10 / M 12

Sheet metal screws, black zinc-plated:

- each 100 pcs. 2.9 x 13 / 2.9 x 16 / 3.5 x 16 / 3.5 x 19 / 3.9 x 19 / 3.9 x 22 / 4.2 x 19 / 4.2 x 25

Flat head sheet metal screws, black zinc-plated:

- each 100 pcs. 3.9 x 16 / 3.9 x 19

Sheet nuts:

- each 100 pcs. 2.9 / 3.5 / 3.9 / 4.2

Blind rivets:

- each 100 pcs. 3 x 12 / 4 x 12 / 4 x 16 / 5 x 12 / 5 x 16
- each 50 pcs. 6 x 12

Storage boxes:

- blue size 2 'S' 63 pieces



Box Programme

Storage boxes:

- Made of shock-resistant polystyrene
- Stackable
- Ideal storage system for small parts

If you order x filled boxes ...	you will get 1 rack free of charge
36 Boxes size 2	Art. No. 9060 36
72 Boxes size 2	Art. No. 9060 72
108 Boxes size 2	Art. No. 9060 108
63 Boxes size 2 and 12 Boxes size 3	Art. No. 9060 63 12
63 Boxes size 2 and 30 Boxes size 3	Art. No. 9060 63 30



Box size 2
Dimension LxWxH:
160 / 140 x 100 x 75 mm

Box size 3
Dimension LxWxH:
230 / 200 x 145 x 125 mm

Hex Head Bolts DIN 933 8.8, Galvanized in Box 2

- Thread up to the head
- Tensile strength 8.8

Article No.	Article Description	QTY
1011B 5 16	BOX(3.0)HEX 933 8.8 GA 5X 16	1
1011B 5 20	BOX(3.0)HEX933 8.8 GA 5X 20	1
1011B 5 25	BOX(3.0)HEX 933 8.8 GA 5X 25	1
1011B 5 30	BOX(3.0)HEX 933 8.8 GA 5X 30	1
1011B 6 10	BOX(2.0)HEX 933 8.8 GA 6X 10	1
1011B 6 16	BOX(2.0)HEX 933 8.8 GA 6X 16	1
1011B 6 20	BOX(2.0)HEX933 8.8 GA 6X 20	1
1011B 6 25	BOX(2.0)HEX933 8.8 GA 6X 25	1
1011B 6 30	BOX(2.0)HEX 933 8.8 GA 6X 30	1
1011B 6 40	BOX(1.5)HEX 933 8.8 GA 6X 40	1
1011B 8 16	BOX(2.0)HEX 933 8.8 GA 8X 16	1
1011B 8 20	BOX(1.5)HEX 933 8.8 GA 8X 20	1
1011B 8 25	BOX(1.5)HEX 933 8.8 GA 8X 25	1
1011B 8 30	BOX(1.0)HEX 933 8.8 GA 8X 30	1
1011B 8 35	BOX(1.0)HEX 933 8.8 GA 8X 35	1
1011B 8 40	BOX(1.0)HEX 933 8.8 GA 8X 40	1
1011B 8 50	BOX(1.0)HEX 933 8.8 GA 8X 50	1
1011B 10 20	BOX(1.0)HEX 933 8.8 GA 10X 20	1
1011B 10 25	BOX(1.0)HEX 933 8.8 GA 10X 25	1
1011B 10 30	BOX(0.5)HEX 933 8.8 GA 10X 30	1
1011B 10 40	BOX(0.5)HEX 933 8.8 GA 10X 40	1

(M × Length mm)



Binding Head Screws DIN7985 4.8, GA in Box 2

- With recessed head
- Galvanized steel

Article No.	Article Description	QTY
1231B 4 20	BOX(2.0) DIN 7985 GA 4X20	1
1231B 5 16	BOX(2.0) DIN 7985 GA 5X16	1
1231B 5 20	BOX(2.0) DIN 7985 GA 5X20	1
1231B 5 25	BOX(2.0) DIN 7985 GA 5X25	1
1231B 6 16	BOX(2.0) DIN 7985 GA 6X16	1
1231B 6 20	BOX(2.0) DIN 7985 GA 6X20	1

(M × length)



Sheet Metal Binding Head Screws DIN 7981 GA, Box

- With PH recessed head
- Galvanized steel

Article No.	Article Description	QTY
1311B 42 13	BOX(5.0)DIN 7981 GA 4.2X13	1
1311B 42 16	BOX(5.0)DIN 7981 GA 4.2X16	1
1311B 42 19	BOX(5.0)DIN 7981 GA 4.2X19	1
1311B 42 25	BOX(5.0)DIN 7981 GA 4.2X25	1
1311B 48 13	BOX(5.0)DIN 7981 GA 4.8X13	1
1311B 48 16	BOX(5.0)DIN 7981 GA 4.8X16	1
1311B 48 19	BOX(3.0)DIN 7981 GA 4.8X19	1
1311B 48 25	BOX(2.5)DIN 7981 GA 4.8X25	1
1311B 48 32	BOX(2.5)DIN 7981 GA 4.8X32	1

(Ø × length mm)



Sheet Metal Binding Head Screws DIN 7981 GA, box 2

- With PH recessed head
- **Black zinc-coated steel**

Article No.	Article Description	QTY
1313B 42 16	BOX(5.0)LK-PH-BL.7981BGA4.2X16	1
1313B 42 19	BOX(5.0)LK-PH-BL.7981BGA4.2X19	1
1313B 42 25	BOX(5.0)LK-PH-BL.7981BGA4.2X25	1
1313B 48 19	BOX(3.0)LK-PH-BL.7981BGA4.8X19	1
1313B 48 25	BOX(2.5)LK-PH-BL.7981BGA4.8X25	1

(Ø × length in mm)



Sheet Metal Flat Round Head DIN 968 Black in Box 2

- With PH recessed head
- **Black zinc-coated steel**

Article No.	Article Description	QTY
1318B 39 13	BOX(5.0)DIN 7981 SW3 3.9X13	1
1318B 39 16	BOX(5.0)DIN 7981 SW3 3.9X16	1
1318B 39 19	BOX(5.0)DIN 7981 SW3 3.9X19	1
1318B 42 13	BOX(5.0)DIN 7981 SW4 4.2X13	1
1318B 42 16	BOX(5.0)DIN 7981 SW4 4.2X16	1
1318B 42 19	BOX(2.5)DIN 7981 SW4 4.2X19	1
1318B 48 13	BOX(3.0)DIN 7981 SW4 4.8X13	1
1318B 48 16	BOX(3.0)DIN 7981 SW4 4.8X16	1
1318B 48 19	BOX(2.5)DIN 7981 SW4 4.8X19	1
1318B 48 25	BOX(2.5)DIN 7981 SW4 4.8X25	1

(Ø × length in mm)



Number Plate Screws with Caps in Box 2

- Similar DIN 7981
- **Zinc-coated steel**

Article No.	Article Description	QTY
1889B 48 16	BOX(2.0) CAPS ZI 4.8X16 B/W	1
1889B 48 19	BOX(2.0) CAPS ZI 4.8X19 B/W	1

(Ø × length in mm / B = black caps, W = white caps)



Hexagonal Sheet Metal Screws with Discs in Box 2

- Hexagonal head with captive washer
- **Zinc-coated steel**

Article No.	Article Description	QTY
1302B 48 19	BOX(2.0)HEX SCREW ZI 4.8X19	1
1302B 56 13	BOX(2.0)HEX SCREW ZI 5.6X13	1
1302B 56 16	BOX(2.0)HEX SCREW ZI 5.6X16	1
1302B 65 16	BOX(2.0)HEX SCREW ZI 6.5X16	1
1302B 65 20	BOX(2.0)HEX SCREW ZI 6.5X20	1

(Ø × Length in mm)



Hexagon Nuts DIN 934-8, Zinc-coated in Box 2

- Tensile strength: 8

Article No.	Article Description	QTY
2001B 4	BOX(5.0)HEX NUTS 934-8 ZI M 4	1
2001B 5	BOX(5.0)HEXNUTS 934-8 ZI M 5	1
2001B 6	BOX(5.0)HEX NUTS 934-8 ZI M 6	1
2001B 8	BOX(3.0)HEX NUTS 934-8 ZI M 8	1
2001B 10	BOX(2.0)HEX NUTS 934-8 ZI M10	1
2001B 12	BOX(1.0)HEX NUTS 934-8 ZI M12	1



Hexagonal Nuts DIN 934-8, Zinc-coated in Box 2

- Tensile strength: 8

Article No.	Article Description	QTY
2101B 5	BOX(5.0) DIN 985 ZI M 5	1
2101B 6	BOX(5.0) DIN 985 ZI M 6	1
2101B 8	BOX(3.0) DIN 985 ZI M 8	1
2101B 10	BOX(1.0) DIN 985 ZI M10	1
2101B 12	BOX(1.0) DIN 985 ZI M12	1



Slotted Nut DIN 14440 in Box 2

- Copper coated steel

Article No.	Article Description	QTY
2140B 8	BOX(3.0) DIN 14440 M 8/13	1
2140B 10	BOX(2.0) DIN 14440 M 10/17	1



Slotted Nuts DIN 14441 in Box 2

- Reduced width across flats
- Copper coated steel

Article No.	Article Description	QTY
2141B 8	BOX(3.0) DIN 14441 M 8 SW 12	1
2141B 10	BOX(2.5) DIN 14441 M10 SW 14	1



Plate Nuts, Spring Steel DIN 17222, Zinc Coa.Box 2

- Application: for material sheet thickness 0.5 – 1.8 mm
- Zinc coated steel

Article No.	Article Description	QTY
2290B 35	BOX(3.0) PLATE NUT 3.5	1
2290B 39	BOX(3.0) PLATE NUT 3.9	1
2290B 42	BOX(3.0) PLATE NUT 4.2	1
2290B 48	BOX(3.0) PLATE NUT 4.8	1
2290B 56	BOX(3.0) PLATE NUT 5.6	1
2290B 65	BOX(2.0) PLATE NUT 6.5	1

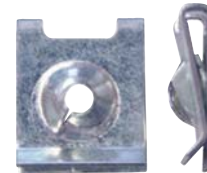

Washers DIN 125 Form A, Zinc Coated in Box 2

- In compliance with ISO 7089
- Zinc coated steel

Article No.	Article Description	QTY
2301B 4	BOX(10.0) DIN 128 A ZI 4	1
2301B 5	BOX(10.0) DIN 125 A ZI 5	1
2301B 6	BOX(10.0) DIN 125 A ZI 6	1
2301B 8	BOX(5.0) DIN 125 A ZI 8	1
2301B 10	BOX(5.0) DIN 125 A ZI 10	1
2301B 12	BOX(2.5) DIN 125 A ZI 12	1



(for M screws)

Washers DIN 9021, Zinc Coated in Box 2

- Form A
- Zinc coated steel

Article No.	Article Description	QTY
2311B 5	BOX(5.0) DIN 9021 ZI 5	1
2311B 6	BOX(5.0) DIN 9021 ZI 6	1
2311B 8	BOX(3.0) DIN 9021 ZI 8	1
2311B 10	BOX(2.0) DIN 9021 ZI 10	1
2311B 12	BOX(1.0) DIN 9021 ZI 12	1



(for M screws)

Body Washers, Zinc Coated in Box 2

Article No.	Article Description	QTY
2331B 5 15	BOX(3.0)BODY WASHER ZI 5X15	1
2331B 5 20	BOX(3.0)BODY WASHER ZI 5X20	1
2331B 6 20	BOX(5.0)BODY WASHER ZI 6X20	1
2331B 8 25	BOX(3.0)BODY WASHER ZI 8X25	1
2331B 10 30	BOX(2.0)BODY WASHER ZI 10X30	1

(for M screws / external Ø in mm)



Snap Rings DIN 127, Zinc Coated in Box 2

- Form B

Article No.	Article Description	QTY
2501B 5	BOX(10.0) DIN 127 ZI 5	1
2501B 6	BOX(10.0) DIN 127 ZI 6	1
2501B 8	BOX(5.0) DIN 127 ZI 8	1
2501B 10	BOX(5.0) DIN 127 ZI 10	1
2501B 12	BOX(2.5) DIN 127 ZI 12	1

(for M screws)



O-Ring Seals DIN 7603 Form A, Solid Copper, Box 2

Article No.	Article Description	QTY
2600B 6 12	BOX(5.0) 7603 A CO 6X12X1	1
2600B 8 12	BOX(3.0) 7603 A CO 8X12X1	1
2600B 10 14	BOX(3.0) 7603 A CO 10X14X1	1
2600B 10 16	BOX(3.0) 7603 A CO 10X16X1	1
2600B 12 16	BOX(3.0) 7603 A CO 12X16X1.5	1
2600B 12 18	BOX(3.0) 7603 A CO 12X18X1.5	1
2600B 14 18	BOX(3.0) 7603 A CO 14X18X1.5	1
2600B 14 20	BOX(4.0) 7603 A CO 14X20X1.5	1
2600B 16 22	BOX(3.0) 7603 A CO 16X22X1.5	1
2600B 18 24	BOX(3.0) 7603 A CO 18X24X1.5	1
2600B 22 27	BOX(2.0) 7603 A CO 22X27X1.5	1

(internal Ø × external Ø × thickness in mm)



O-Ring Seals DIN 7603 Form C, Colour. Copper Box 2

Article No.	Article Description	QTY
2610B 14 20	BOX(3.0) DIN 7603 C CO 14X20	1
2610B 16 22	BOX(3.0) DIN 7603 C CO 16X22	1

(internal Ø × external Ø × thickness in mm)



Automotive Rubber Valves in Box 2

- Rubber valves for tubeless tyres, up to 4.5 bar at 20 °C
- Made in Germany

Article No.	Article Description	QTY
3570B 413	BOX(0.45) VALVES TR-413	1
3570B 414	BOX(0.45) VALVES TR-414	1
3570B 418	BOX(0.35) VALVES TR-418	1



Versatile Blind Rivets Flat Round Head AL/St Box 2

Rivet Housing: Aluminium

Rivet pin: zinc coated steel

- Large clamping area:
 - low stock holding
 - reduction of error sources
- Optimal drill hole filling and secure rivet locking when forming the closing head
- Strong and spray water tight rivet connection
- Extended drill hole area

Article No.	Article Description	QTY
2730B 32 95	BOX(2.5)RIV.TR-HD AL/ST3.2X9.5	1
2730B 32 111	BOX(2.5)RI.TR-HD AL/ST3.2X11.1	1
2730B 4 95	BOX(2.5)RIV.TR-HD AL/ST 4X9.5	1
2730B 4 127	BOX(2.5)RIV.TR-HD AL/ST 4X12.7	1
2730B 4 169	BOX(2.5)FRK-MB-N.AL/ST 4X16	1
2730B 48 103	BOX(2.5)RI.TR-HD AL/ST4.8X10.3	1
2730B 48 169	BOX(2.5)FRK-MB-N.AL/ST4.8X17	1
2730B 48 248	BOX(2.5)RI.TR-HD AL/ST4.8X24.8	1



(Ø × length mm)

Vers. Blind Rivets Large Flat Round Head AL/St Box 2

Rivet housing: Aluminium

Rivet pin: zinc coated steel

- Large clamping area:
 - low stock holding
 - reduction of error sources
- Optimal drill hole filling and secure rivet locking when forming the closing head
- Strong and spray water tight rivet connection
- Extended drill hole area

Article No.	Article Description	QTY
2731B 4 11	BOX(2.0)RIV.TR-HD AL/11 4X11	1
2731B 4 12	BOX(2.5)RIV.TR-HD AL/11 4X12	1
2731B 4 16	BOX(2.0)RIV.TR-HD AL/11 4X16	1
2731B 48 16	BOX(1.0)RIV.TR-HD AL/16 4.8X16	1
2731B 48 10	BOX(2.0)RIV.TR-HD AL/16 4.8X10	1
2731B 48 24	BOX(1.0)RIV.TR-HD AL/16 4.8X24	1



(Ø × length mm)

Hose Clamp W2 TORRO in Box 2

- Weld free and rivet free housing
- No tilting when tightening
- Short housing gauge guarantees optimal form fit and even contact
- Slotted or slotted / recessed head combination hexagonal screw
- Embossed ring with turned up edges to avoid damage to the hose

Article No.	Article Description	QTY
3200B 8 16	BOX(1.0) HOSETORRO9MMSW7 8-16	1
3200B 8 12	BOX(1.0) HOSETORRO7.5MM6/ 8-12	1
3200B 10 16	BOX(1.0) HOSETORRO7.5MM6/10-16	1
3200B 12 20	BOX(0.5) HOSETORRO9MMSW7 12-20	1
3200B 16 25	BOX(0.5) HOSETORRO9MMSW7 16-25	1
3200B 20 32	BOX(0.3) HOSETORRO9MMSW7 20-32	1
3200B 25 40	BOX(0.25)HOSETORRO9MMSW7 25-40	1
3200B 32 50	BOX(0.15)HOSETORRO9MMSW7 32-50	1
3200B 40 60	BOX(0.1) HOSETORRO9MMSW7 40-60	1
3200B 50 70	BOX(0.1) HOSETORRO9MMSW7 50-70	1

(ring width / hose clamp / material / spread)



Hose Clamp W2 TORRO in Box 3

- Weld free and rivet free housing
- No tilting when tightening
- Short housing gauge guarantees optimal form fit and even contact pressure for the whole circumference
- Slotted or slotted / recessed head combination hexagonal screw

Article No.	Article Description	QTY
3200G 8 12	BOX(2.0)HOSETORRO7.5MM/6 8-12	1
3200G 8 16	BOX(2.0)HOSETORRO9MM SW7 8-16	1
3200G 10 16	BOX(2.0)HOSETORRO7.5MM/6 10-16	1
3200G 12 20	BOX(2.0)HOSETORRO9MM SW7 12-20	1
3200G 16 25	BOX(2.0)HOSETORRO9MM SW7 16-25	1
3200G 20 32	BOX(1.5)HOSETORRO9MM SW7 20-32	1
3200G 25 40	BOX(1.0)HOSETORRO9MM SW7 25-40	1
3200G 32 50	BOX(0.5)HOSETORRO9MM SW7 32-50	1
3200G 40 60	BOX(0.5)HOSETORRO9MM SW7 40-60	1
3200G 50 70	BOX(0.5)HOSETORRO9MM SW7 50-70	1

(ring width / hose clamp / material / spread)



Ins. Cable Connector f. Cable 0.25 – 1.0 mm² Box 2

Article No.	Article Description	QTY
3700B 851	BOX(3,0) INSCONNECT 851	1
3700B 855	BOX(3,0) INSCONNECT 855	1
3700B 901	BOX(3,0) INSCONNECT 901	1
3700B 906	BOX(3,0) INSCONNECT 906	1
3700B 907	BOX(3,0) INSCONNECT 907	1
3700B 908	BOX(3,0) INSCONNECT 908	1
3700B 909	BOX(3,0) INSCONNECT 909	1
3700B 911	BOX(3,0) INSCONNECT 911	1
3700B 912	BOX(3,0) INSCONNECT 912	1
3700B 913	BOX(3,0) INSCONNECT 913	1
3700B 924	BOX(3,0) INSCONNECT 924	1
3700B 926	BOX(3,0) INSCONNECT 926	1
3700B 930	BOX(3,0) INSCONNECT 930	1
3700B 933	BOX(3,0) INSCONNECT 933	1
3700B 937	BOX(3,0) INSCONNECT 937	1
3700B 941	BOX(3,0) INSCONNECT 941	1
3700B 970	BOX(3,0) INSCONNECT 970	1

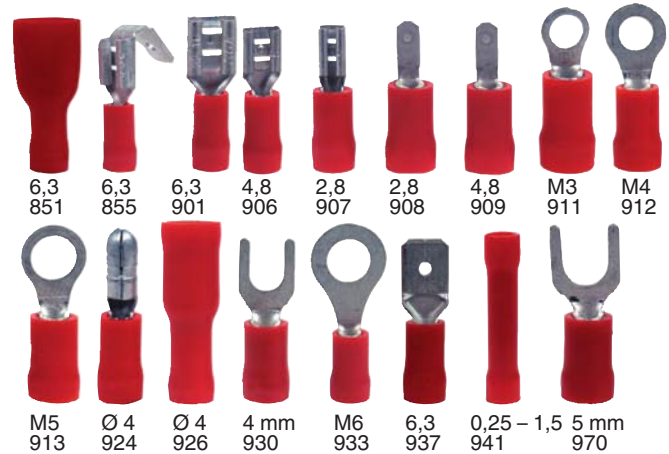

Ins. Cable Connectors f. Cable 1.5 – 2.5 mm² Box 2

Article No.	Article Description	QTY
3700B 852	BOX(3,0) INSCONNECT 852	1
3700B 902	BOX(5,0) INSCONNECT 902	1
3700B 903	BOX(3,0) INSCONNECT 903	1
3700B 905	BOX(3,0) INSCONNECT 905	1
3700B 914	BOX(3,0) INSCONNECT 914	1
3700B 915	BOX(3,0) INSCONNECT 915	1
3700B 916	BOX(3,0) INSCONNECT 916	1
3700B 917	BOX(3,0) INSCONNECT 917	1
3700B 918	BOX(3,0) INSCONNECT 918	1
3700B 919	BOX(3,0) INSCONNECT 919	1
3700B 925	BOX(3,0) INSCONNECT 925	1
3700B 927	BOX(3,0) INSCONNECT 927	1
3700B 931	BOX(3,0) INSCONNECT 931	1
3700B 934	BOX(3,0) INSCONNECT 934	1
3700B 936	BOX(3,0) INSCONNECT 936	1
3700B 939	BOX(3,0) INSCONNECT 939	1
3700B 946	BOX(3,0) INSCONNECT 946	1
3700B 971	BOX(3,0) INSCONNECT 971	1



Ins. Cable Connectors f. Cable 4.0 – 6.0 mm² Box 2

Article No.	Article Description	QTY
3700B 900	BOX(2,0) INSCONNECT 900	1
3700B 904	BOX(3,0) INSCONNECT 904	1
3700B 920	BOX(2,0) INSCONNECT 920	1
3700B 921	BOX(2,0) INSCONNECT 921	1
3700B 922	BOX(2,0) INSCONNECT 922	1
3700B 923	BOX(2,0) INSCONNECT 923	1
3700B 928	BOX(3,0) INSCONNECT 928	1
3700B 929	BOX(3,0) INSCONNECT 929	1
3700B 932	BOX(3,0) INSCONNECT 932	1
3700B 935	BOX(3,0) INSCONNECT 935	1
3700B 940	BOX(3,0) INSCONNECT 940	1
3700B 948	BOX(3,0) INSCONNECT 948	1
3700B 972	BOX(3,0) INSCONNECT 972	1



Cable Brace Connectors in Box 2

Article No.	Article Description	QTY
3701B 950	BOX(1.0) INSCONNECT 950	1
3701B 957	BOX(1.0) INSCONNECT 957	1
3701B 964	BOX(0.7) INSCONNECT 964	1
3701B 962	BOX(1.0) INSCONNECT 962	1
3701B 963	BOX(1.0) INSCONNECT 963	1

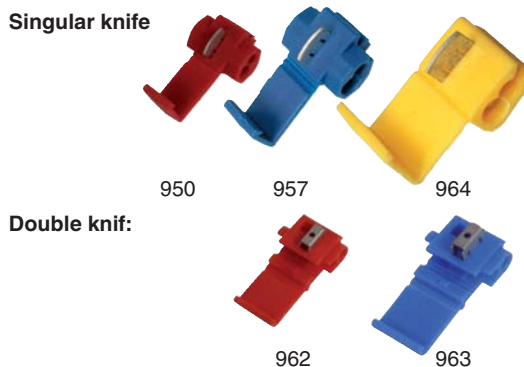

Removable Cable Brace Connectors in Box 2

Article No.	Article Description	QTY
3701B 975	BOX(1.0) INSCONNECT 975	1
3701B 978	BOX(1.0) INSCONNECT 978	1
3701B 976	BOX(1.0) INSCONNECT 976	1
3701B 979	BOX(1.0) INSCONNECT 979	1
3701B 977	BOX(1.0) INSCONNECT 977	1
3701B 980	BOX(1.0) INSCONNECT 980	1



Standard Flat Blade Fuses in Box 2

Article No.	Article Description	QTY
3810B 3	BOX(1,5) BLADEFUSE 3 A	1
3810B 5	BOX(1,5) BLADEFUSE 5 A	1
3810B 75	BOX(1,5) BLADEFUSE 7,5 A	1
3810B 10	BOX(1,5) BLADEFUSE 10 A	1
3810B 15	BOX(1,5) BLADEFUSE 15 A	1
3810B 20	BOX(1,5) BLADEFUSE 20 A	1
3810B 25	BOX(1,5) BLADEFUSE 25 A	1
3810B 30	BOX(1,5) BLADEFUSE 30 A	1



Universal Fuel Filter in Box 3

Article No.	Article Description	QTY
3906G 1	BOX<0,32> FUELFILTER	1



Heat Shrinking Cable Connectors in Box 2

- With integrated glue
- High tension relief due to fixed bonding with the cable insulation
- Completely waterproof
- No additional insulation or sealing requirement
- Excellent resilience against abrasion and cutting
- Temperature range: -55 °C to +125 °C

Use:

- Insert exposed cable and squeeze with crimper
- Heat shrink hose with heat source e.g. lighter, hot air stream etc. until glue contract out of the side connected with the cable

Article No.	Article Description	QTY
3702B 801	BOX(1,0) HEATSHRINKCONN 801	1
3702B 802	BOX(1,0) HEATSHRINKCONN 802	1
3702B 836	BOX(1,0) HEATSHRINKCONN 836	1
3702B 837	BOX(1,0) HEATSHRINKCONN 837	1
3702B 839	BOX(1,0) HEATSHRINKCONN 839	1
3702B 840	BOX(1,0) HEATSHRINKCONN 840	1
3702B 841	BOX(1,0) HEATSHRINKCONN 841	1



Cable Ties in Box

- Material: Polyamide 6.6
- Temperature range from -55 °C to +100 °C
- For the quick bundling of cables, cable looms, hoses etc.
- Insertion of the tie into eyelet is easy due to the upright tie point
- Once fastened cannot be reopened

Article No.	Article Description	QTY
3750B 25 102	BOX(3.5)CABLETIESBLACK 2.5X102	1
3750B 35 145	BOX(3.5)CABLETIESBLACK 3.5X145	1
3750B 35 215	BOX(2.5)CABLETIESBLACK 3.5X200	1
3750B 47 195	BOX(2.5)CABLETIESBLACK 4.7X195	1
3750B 47 285	BOX(2.0)CABLETIESBLACK 4.7X285	1
3750B 78 202	BOX(1.5)CABLETIESBLACK 7.8X202	1
3750B 78 282	BOX(1.0)CABLETIESBLACK 7.8X282	1

Colour: black



Cable Ties with Steel Point in Box

- Polyamid 6.6 weatherproof and UV resistant
- Material class: UL94V-2
- With rounded edges and inside neps to avoid sliding sideways
- Unmagnetic stainless steel point
- Temparture range from -40 °C to +85 °C
- Color: black

Article No.	Article Description	QTY
3756B 36 140	BOX(3.5)CABLETIES MZ 3.6X140	1
3756B 36 208	BOX(2.5)CABLETIES MZ 3.6X208	1
3756B 48 186	BOX(2.5)CABLETIES MZ 4.8X186	1
3756B 48 293	BOX(1.5)CABLETIES MZ 4.8X293	1
3756B 76 203	BOX(2.0)CABLETIES MZ 7.6X203	1



PC Cabinet with Casters

- stable, durable steel construction
- abrasion tested and environmentally friendly powder coating
- on casters (for self-assembly, 2 swivel and 2 fixed castors)
- ventilation slots in the back panel
- electrical connections installed
- cooling fan
- to accommodate flat panel display (monitor compartment lockable with transparent disc), printer (height-adjustable shelf), keyboard and mouse (storage extendable and lockable)

Technical Data

Height with wheels:	1850 mm
Height without wheels:	1750 mm
Width:	640 mm
Depth:	630 mm



Article No.	Article Description	QTY
9100 26	PC CABINET WITH CASTERS	1

Workshop Planner for 48 Order Bags

- Workshop planner for 48 order bags in size DIN A4, 8 rows
- With holder for pens and highlighters
- For wall mounting
- RAL 5003 blue
- Dimensions (H x W x D): 934 x 1550 x 80 mm
- Weight: 42 kg

Article No.	Article Description	QTY
9100 848	WORKSHOP PLANNER 48 ORDER BAGS	1



Workshop Planner for 24 Order Bags

- Workshop planner for 24 order bags in size DIN A4, 8 rows
- With holder for pens and highlighters
- For wall mounting
- RAL 5003 blue
- Dimensions (H x W x D): 934 x 800 x 80 mm
- Weight: 23 kg

Article No.	Article Description	QTY
9100 824	WORKSHOP PLANNER 24 ORDER BAGS	1



Workshop Wagon – Mobile Diagnostics

- Professional diagnostics workshop wagon for car and commercial vehicle operations

- Weight: 43 kg
- Body colour: blue (RAL 5003)
- Drawer colour: anthracite grey (RAL 7016)

Dimensions (H x W x D):

- Diagnostics cart: 1.155 x 485 x 400 mm
- Drawer: 70 x 300 x 340 mm
- Block rollers: ø 125 mm
- Castors: ø 125 mm, braked

Your Advantage / Benefit

- For the clean and orderly storage of diagnostic tools
- The upper rubber-coated support is particularly suited for a diagnostic laptop
- The lockable folding cover serves as visual, glare and dust protection and as a writing surface
- 1 lockable compartment with 2 shelves, which are used to store printer and diagnostic accessories
- 1 drawer for additional accessories from the diagnostics assortment
- Integrated triple socket with 5 m long connection cable
- Compact design

Application

- Ideally suited for the usage of car and commercial vehicle diagnostic devices



Article No.	Article Description	QTY
4990 440	WORKSHOP WAGON-MOBILE DIAGN.	1
4990 440 1	SHELVES FOR DIAGNOSTICS MOBILE	1

Workshop Shelf Trolley 220 „Standard“

- High-quality mobile workshop shelving unit
- Total load-bearing capacity: 250 kg
- Load per shelf: 100 kg
- Colour: blue (RAL 5003)

Dimensions:

- Workshop shelf trolley (H×W×D): 1,202×1,080×500 mm
- Block rollers ø: 125 mm
- Casters ø: 125 mm



Your Advantage / Benefit

- Mobile workshop shelf trolley
- Large shelves for storing tools, working equipment, bodywork and assembly components plus spare parts and case sets
- Height-adjustable middle shelf
- The shelves can also be assembled with raised outside edge
- The top two shelves are fully galvanized for increased resistance to corrosion and chemicals
- Ergonomic grip height of 880 mm
- Orderly and organised workplace

Application

- Ideal for automotive dismantling and assembly work
- Perfect addition to the storage area
- Ideal service trolley for inspections and major repairs



Article No.	Article Description	QTY
4990 220	WORKS.SHELF TROLLEY STANDARD	1

Related Products

- Galvanised Shelf for Workshop Trolley
Art. No. 4990 220 1

- Rubber Insert for Workshop Trolley 220
Art. No. 4990 220 2



Tool Trolley Pro XXL

Art. No. 4990 820 Tool trolley Profi XXL:

- Dimensions (H x W x D): 940 x 993 x 490 mm
- Robust sheet steel version with robust substructure
- Working platform made of ABS plastic with small part trays, load capacity 200 kg
- 5 drawers, inside size (H x W x D): 65 x 865 x 410 mm, height of orifice 75 mm
- 2 drawers, inside size (H x W x D): 140 x 865 x 410 mm, height of orifice 150 mm
- Load capacity of the single drawers: 35 kg, ball bearing, extendible
- Drawers with individual lockings, integrated in the orifice
- Central locking system with cylinder lock, lockable
- Back board with square perforation
- Robust sliding handle
- 2 fixed and 2 braked steering rollers, Ø 125 mm
- Suitable slotted wall: Art. No. 4990 812

Art. No. 4990 821 Cabinet for tool trolley Profi XXL:

- Dimensions (H x W x D): 495 x 993 x 485 mm
- Big packages with head, lockable
- Drawers with individual lockings, integrated in the orifice
- Central locking system with cylinder lock, lockable
- 4 drawers, inside size (H x W x D): 65 x 865 x 410 mm, height of orifice 75 mm
- Load capacity of single drawers: 35 kg, ball bearing, extendible
- 2 big robust handles, lateral at the cabinet

Art. No. 4990 829 Tool trolley Profi XXL Kombi:

- With cabinet
- Not assembled

Art. No. 4990 830 Set:

- Height: 50 mm
- 3 slotted walls, length: 409 mm
- 6 slotted, length: 201 mm
- 6 separating plates, length: 227 mm

Art. No. 4990 831 Set:

- Height: 100 mm
- 3 slotted walls, length: 409 mm
- 6 separating plates, length: 201 mm
- 6 separating plates, length: 227 mm



Individual locking of any drawer avoids unintentional opening when ranking, ball bearing guide bars are standard

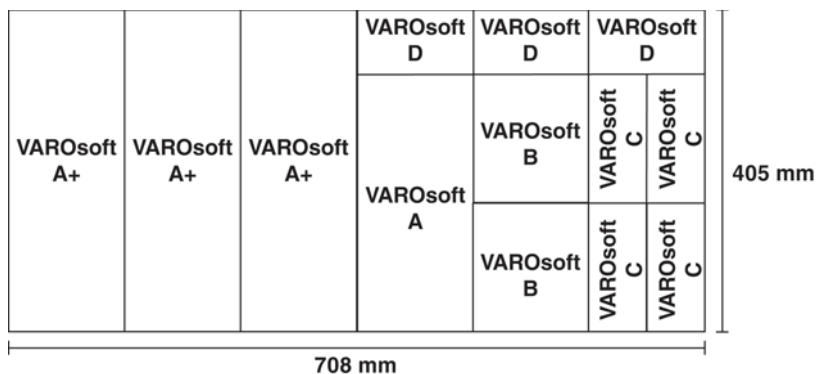

Arrangement of drawers

Article No.	Article Description	QTY
4990 820	TOOL TROLLEY PROFİ XXL	1
4990 821	CABINET F.TOOL TROLL.PROFI XXL	1
4990 829	TOOL TROLLEY PROFİ XXL KOMBI	1
4990 830	TRAY P.SET F.TOOL T.XXL H50MM	1
4990 831	TRAY P.SET F.TOOL T.XXL H100MM	1

Tool Trolley Mechanic



Stable handle

Solvent-resistant plastic-worktop

Tested with 40 kg according to DIN , 25 kg load per drawer is recommended

All drawers 100% telescopic due to ball bearing telescopic slide

Individual locking of every drawer prevents unintended opening when shunting, ball bearing guide rails are standard

Big surfaces for attaching accessories at the side

3-phase locking concept for higher security
 - Central locking with cylinder lock + 2 keys
 - Individual locking
 - Plus pull-out stop for minimum tilting risk (can be deactivated by the user with a few manual adjustments)

Ball bearing rollers Ø 125 mm



4990 179 180 33



4990 179 180 34



4990 179 31 4



4990 179 32 4

- Telescopic drawers
- Drawers 100% telescopic
- Individual drawer locking with pull-out stop
- Central locking for drawers lockable
- Load capacity of drawers according to DIN tested with 40 kg
- Stable handle mounted at corpus
- Solvent-resistant worktop
- Rectangle hole grid at the side walls
- Edge protection at every corner

Art. No. 4990 179:

- Tool trolley mechanic blue /light grey (RAL5003 / RAL7035)

Art. No. 4990 179 1:

- Tool trolley mechanic black / light grey (RAL 9005/ RAL 7035)

Art. No. 4990 179 2:

- Tool trolley mechanic red / red light grey (RAL 2002 / RAL 7035)

Art. No. 4990 179 0 1:

- Tool trolley mechanic blue / anthracite (RAL 5003 / RAL 7016)

Art. No. 4990 179 1 1:

- Tool trolley mechanic black / anthracite (RAL 9005 / RAL 7016)

Art. No. 4990 179 2 1:

- Tool trolley mechanic red / anthracite (RAL 2002 / RAL 7016)

Dimensions:

- Trolley (H x W x D): 1,040 x 817 x 502 mm
- Drawers (H x W x D): : 5x 75 x 524 x 398 mm, 2x 160 x 524 x 398 mm
- High-quality ball bearing rollers Ø 125 mm



4990 179 0 1

4990 179 1 1

4990 179 2 1

Article No.	Article Description	QTY
4990 179	TOOL TROLLEY MECHANIC BLUE	1
4990 179 1	TOOL TROLLEY MECHANIC BLACK	1
4990 179 2	TOOL TROLLEY MECHANIC RED	1
4990 179 0 1	TOOL TROLLEY BLUE/ANTCRACITE	1
4990 179 1 1	TOOL TROLLEY BLACK/ANTHRACITE	1
4990 179 2 1	TOOL TROLLEY RED/ANTHRACITE	1
4990 179 31 4	SHELF DIV.SET F.179 DRAW.FLAT	1
4990 179 32 4	SHELF DIV.SET F.179 DRAW.HIGH	1
4990 179 180 33	RECYCLE BIN FOR TROLLEY 179	1
4990 179 180 34	HOLD.FOR PAP.ROLL F.TROLLEY179	1
5001 80 08	180-08 CYLINDER LOCK+KEY	1
5001 79 011	179-011 SWIVEL CAST.W.LOCKABL.	1
5001 79 09	179-09 FIXED CASTOR	1



Tool Trolley Mechanic XL



- Telescopic drawers
- Drawers 100% telescopic
- Individual drawer locking with pull-out stop
- Central locking for drawers lockable
- Load capacity of drawers according to DIN tested with 40 kg
- Stable handle mounted at corpus
- Solvent-resistant worktop
- Rectangle hole grid at the side walls
- Edge protection at every corner

Art. No. 4990 179:

- Tool trolley mechanic blue /light grey (RAL5003 / RAL7035)

Art. No. 4990 179 1:

- Tool trolley mechanic black / light grey (RAL 9005/ RAL 7035)

Art. No. 4990 179 2:

- Tool trolley mechanic red / red light grey (RAL 2002 / RAL 7035)

Art. No. 4990 179 0 1:

- Tool trolley mechanic blue / anthracite (RAL 5003 / RAL 7016)

Art. No. 4990 179 1 1:

- Tool trolley mechanic black / anthracite (RAL 9005 / RAL 7016)

Art. No. 4990 179 2 1:

- Tool trolley mechanic red / anthracite (RAL 2002 / RAL 7016)

Dimensions:

- Trolley (H x W x D): 1,040 x 817 x 502 mm
- Drawers (H x W x D): : 5x 75 x 524 x 398 mm, 2x 160 x 524 x 398 mm
- High-quality ball bearing rollers Ø 125 mm



4990 173 0 1

Article No.	Article Description	QTY
4990 173	TOOL TROLLEY MECHANIC XL BLUE	1
4990 173 0 1	TOOL TROLLEY XL BLUE/ANTHRAC.	1

VAROsoft A+ 120 mm	VAROsoft A+	VAROsoft D	VAROsoft D	VAROsoft D		405 mm
		VAROsoft A	VAROsoft B	VAROsoft C	VAROsoft C	
			VAROsoft B	VAROsoft C	VAROsoft C	
			VAROsoft B	VAROsoft C	VAROsoft C	
694 mm						

Tool Trolley 179 XL



Big surfaces for attaching accessories at the side

Ball bearing rollers Ø 125 mm

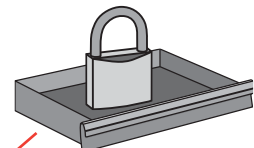
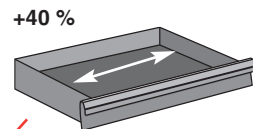

100 % pull out + self closing and soft close

- Made in Germany
- 40 % more drawer volume than conventional tool trolleys
- Telescopic slide rails
- 100 % removal of drawers
- Self closing and soft close drawers
- Single locking of the drawers with mutual extension lock
- Central locking for drawers lockable
- Drawer capacity checked according to DIN with 40 kg
- Stable driving grip fitted to the body
- Stainless steel worktop
- Rectangular hole pattern on the side walls
- Edge protection on all corners
- Total load capacity 1,000 kg

Dimension:

- Tool trolley (H x W x D): 1,027 x 980 x 503 mm
- Total weight 101 kg
- Drawers (H x W x D): 5x 80 x 694 x 398 mm, 2x 165 x 694 x 398 mm
- High-quality ball bearing rollers: Ø 125 mm



Hole pattern
Art. No. 4990 179 5 3



Side door
Art. No. 4990 179 5 1

Article No.	Article Description	QTY
4990 179 5	TOOL TROLL.W.ASSITANT BU 179XL	1
4990 179 5 1	SIDE DOOR F.179XL,XXL A.TXXL	1
4990 179 5 3	HOLE PATTERN FOR 179 XL	1
5001 73 31 5	173-31/5 DIVIDING SHEET SET	1
5001 73 32 5	173-32/5 DIVIDING SHEET SET	1

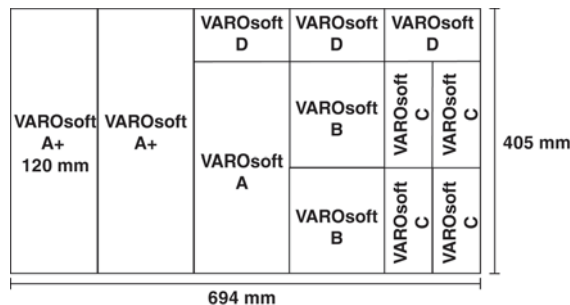

Tool Trolley 179 TXXL



Big surfaces for attaching accessories at the side

Ball bearing rollers Ø 125 mm

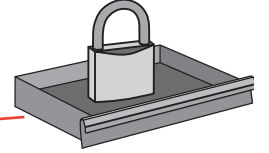
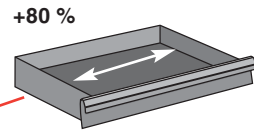

100 % pull out + self closing and soft close

- Made in Germany
- 80% more drawer volume than conventional tool trolleys
- telescopic slide rails
- 100% removable drawers
- self closing and soft close drawers
- single locking of the drawers with mutual extension lock
- central locking for drawers lockable
- drawer capacity checked according to DIN with 40 kg
- stable driving grip fitted to the body
- stainless steel worktop
- rectangular hole pattern on the side walls
- edge protection on all corners
- total load capacity 1,000 kg

Dimension:

- tool trolley HxWxD: 1,027x1155x503 mm
- total weight 122 kg
- drawers HxWxD: 5x 80x871x398 mm, 2x 165x871x398 mm
- high-quality ball bearing rollers: Ø 125 mm



Hole pattern
Art. No. 4990 179 6 3



Side wall
Art. No. 4990 179 5 1

Article No.	Article Description	QTY
4990 179 6	TOOL TROLL.W.ASSIST.BU 179XXL	1
4990 179 5 1	SIDE DOOR F.179XL,XXL A.TXXL	1
4990 179 6 3	HOLE PATTERN FOR 179XXL A.TXXL	1
5001 73 31 5	173-31/5 DIVIDING SHEET SET	1
5001 73 32 5	173-32/5 DIVIDING SHEET SET	1

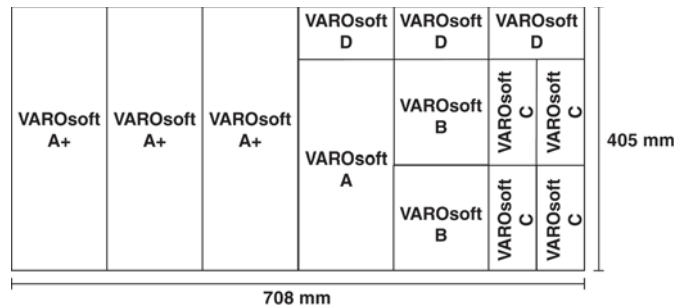

Tool Trolley 861 STRONG



- Reinforced version
- Single lock for each drawer
- Central locking for drawers lockable
- Total load capacity: 350 kg
- Drawer capacity: 40 kg
- Tool trolley blue (RAL 5003), red (RAL 2002), black (RAL 9005)
- Drawer anthracite grey (RAL 7016), drawers light grey (RAL 7035)

Dimensions:

- Tool Trolley (H x W x D): 990 x 710 x 545 mm
- 5x drawers (H x W x D): 70 x 578 x 410 mm
- 2x drawers (H x W x D): 150 x 578 x 410 mm
- Fixed castors Ø 125 mm
- Swivel castors Ø 125 mm, with brakes

Art. No. 4990 860 11:

- 2x slot walls, 3x separating plates L-133 mm, 3x separating plates L-167 mm, 3x separating plates L-269 mm

Art. No. 4990 860 13:

- 2x slot walls, 3x separating plates L-269 mm, 3x separating plates L-167 mm, 3x separating plates L-133 mm



Article No.	Article Description	QTY
4990 861 0	TOOL TROLLEY BLUE/GREY STRONG	1
4990 861 10	TOOL TROLLEY RED/GREY STRONG	1
4990 861 20	TOOL TROLLEY BLACK/GREY STRONG	1
4990 861	TOOL TROLLEY BLUE/ANTHR.STRONG	1
4990 861 1	TOOL TROLLEY RED /ANTHR.STRONG	1
4990 861 2	TOOL TROLL.BLACK /ANTHR.STRONG	1
4990 861 4	SWIVEL CASTOR FOR 861/661	1
4990 861 5	FIXED CASTOR FOR 861/661STRONG	1
4990 861 6	PAIR(2)TELESC.SLIDE STRONG 861	1
4990 861 7	REPL.HANDLE FOR 861/661 STRONG	1
4990 861 8	CASTLE FOR T.T.STRONG 861/661	1
4990 860 11	TRAY P.SET F.TOOL TROLLEY 860	1
4990 860 12	SLOTTED WALL F.T.TROLLEY 860	1
4990 860 13	TRAY P.SET FOR 860 BIG DRAWER	1

Tool Trolley 862 Strong



- Reinforced version
- Individual lock for each drawer
- Central closure mechanism for drawers can be locked
- Total load bearing capacity: 350 kg
- Drawer load bearing capacity: 40 kg
- Tool trolley, blue (RAL 5003), black (RAL 9005)
- Drawer, anthracite grey (RAL 7016), drawer, light grey (RAL 7035)

Dimensions:

- Tool trolley (H x W x D): 990 x 710 x 545 mm
- 7x drawers (H x W x D): 70 x 578 x 410 mm
- 1x drawer (H x W x D): 150 x 578 x 410 mm
- Fixed castors Ø 125 mm
- Swivel castors Ø 125 mm, with brakes

Art. No. 4990 860 11:

- 2x perforated walls, 3x partitions L-133 mm, 3x partitions L-167 mm, 3x partitions L-269 mm

Art. No. 4990 860 13:

- 2x perforated walls, 3x partitions L-269 mm, 3x partitions L-167 mm, 3x partitions L-133 mm

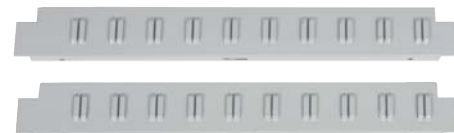

4990 860 11

Article No.	Article Description	QTY
4990 862	TOOL TROLL.BLUE/ANTHR.S.STRONG	1
4990 862 0	TOOL TROLLEY BLUE/GREY STRONG	1
4990 862 2	TOOL TROLL.BLACK/ANTH. STRONG	1
4990 861 4	SWIVEL CASTOR FOR 861/661	1
4990 861 5	FIXED CASTOR FOR 861/661STRONG	1
4990 861 6	PAIR(2)TELESC.SLIDE STRONG 861	1
4990 861 7	REPL.HANDLE FOR 861/661 STRONG	1
4990 861 8	CASTLE FOR T.T.STRONG 861/661	1
4990 860 11	TRAY P.SET F.TOOL TROLLEY 860	1
4990 860 12	SLOTTED WALL F.T.TROLLEY 860	1
4990 860 13	TRAY P.SET FOR 860 BIG DRAWER	1

Tool Trolley 661 STRONG



Individual locking of any drawer avoids un-intentional opening when ranking, ball bearing guide bars are standard.

Can be combined optimal with e.g. the extension table and chemical storage due to the Euro-standards holes

- Reinforced version
- Individual lock for every drawer
- Central locking system may be activated for drawers
- Total load capacity: 300 kg
- Load capacity of each drawer: 40 kg
- Back panel with 2 double rows of Euro-standard holes
- Tool trolley available in blue (RAL 5003), red (RAL 3020), black (RAL 9005)
- Light grey drawers (RAL 7035)

Dimensions:

- Tool trolley (H x W x D): 950 x 610 x 450 mm
- 4x drawers (H x W x D): 65 x 442 x 350 mm
- 1x drawer (H x W x D): 145 x 442 x 350 mm
- 1x drawer (H x W x D): 225 x 442 x 350 mm
- Fixed castors Ø 125 mm
- Swivel castors Ø 125 mm, with brakes



4990 661 10

4990 661 20



4990 661

4990 661 1

4990 661 2

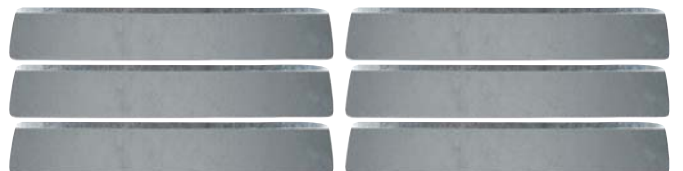

Article No.	Article Description	QTY
4990 661 0	TOOL TROLLEY BLUE/GREY STRONG	1
4990 661 10	TOOL TROLLEY RED /GREY STRONG	1
4990 661 20	TOOL TROLLEY BLACK/GREY STRONG	1
4990 661	TOOL TROLLEY BLUE/ANTHR.STRONG	1
4990 661 1	TOOL TROLLEY RED /ANTHR.STRONG	1
4990 661 2	TOOL TROLL.BLACK/ANTRHR.STRONG	1
4990 663	PCK(6)TRAY PART.SET F.WSW 660	1
4990 665	PCK(6)TRAY PART.SET BIG DR.660	1
4990 861 4	SWIVEL CASTOR FOR 861/661	1
4990 861 5	FIXED CASTOR FOR 861/661STRONG	1
4990 661 6	PAIR(2)TELESC.RAIL 661 STRONG	1
4990 861 7	REPL.HANDLE FOR 861/661 STRONG	1
4990 861 8	CASTLE FOR T.T.STRONG 861/661	1
4990 660 9	PLASTIC SHELF F.T.T. 660/661	1

Toolbox STRONG

- High-quality, reinforced toolbox for the automotive and construction sectors
- Toolbox blue (RAL 5003), drawers light grey (RAL 7035)
- Contents not included

Suitable for workshop trolley of Series:

- 179, 861, 740

Dimensions:

- Toolbox (H x W x D): 285 x 525 x 340 mm



Big compartment
e.g. for machines

Stable closing system

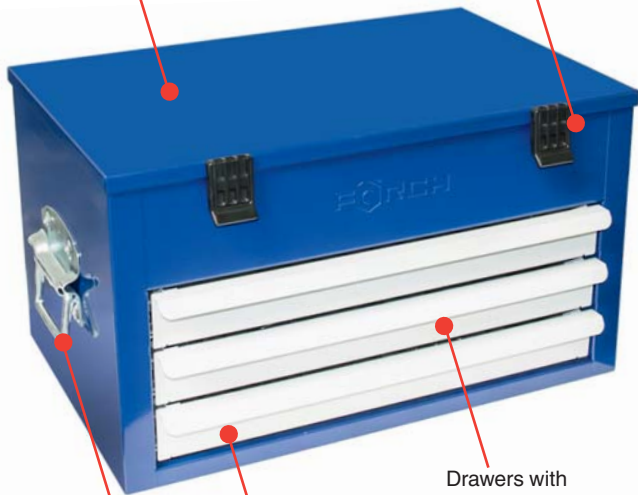

Stable, galvanised handles

Drawers with self closure



3 drawers with stopping function to avoid uncontrolled opening
Height: 50 mm for compatibility with the VAROsoft insert

Your Advantage / Benefit

- Structured and orderly storage of tools, small parts and replacement parts
- Central locking for all drawers by closing the cover

Application

- For mobile use in the vehicle and on the workshop trolley



Examples of VAROsoft inserts:

VAROsoft A+	VAROsoft D	VAROsoft D	VAROsoft D
	VAROsoft A	VAROsoft B	VAROsoft C
		VAROsoft C	VAROsoft C

Article No.	Article Description	QTY
4990 525	TOOLBOX STRONG	1

Related Products

- VAROsoft System Inserts, Non-Equipped
Art. No. 9026 70, 9026 70 1
Art.-No 9026 60, 9026 80
Art. No. 9026 90, 9026 101



- Tool Kit 47-part
Art. No. 4990 2

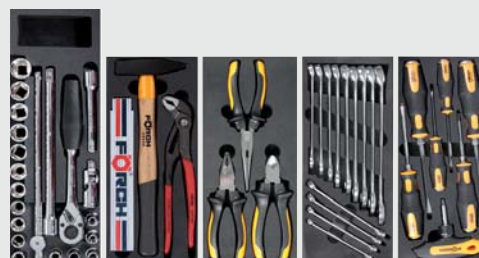

Wooden Shelf for Tool Trolley 661 / 861

- 18 mm thick birch multiplex board
- Art. No. 4990 661 9: suitable for tool trolley Art. No. 4990 661
- Art. No. 4990 861 9: suitable for tool trolley Art. No. 4990 861

Dimensions:

- Art. No. 4990 661 9 (L x W): 59.5 x 43.3 cm
- Art. No. 4990 861 9 (L x W): 70.0 x 54.0 cm

Note:

- The plastic shelf on the trolley can be removed undamaged by heating with a hot air blower



Example with 4990 661 0



Example with 4990 861 0

Article No.	Article Description	QTY
4990 661 9	WOODEN SHELF F.T.TROLL.660/661	1
4990 861 9	WOODEN SHELF F.T.TROLL.860/861	1

Your Advantage / Benefit

- Robust and stable shelf

Application

- For disassembly and assembly work

Related Products

- Tool Trolley 661 STRONG
Art. No. 4990 661 ...



- Tool Trolley 861 STRONG
Art. No. 4990 861 ...



- Vices
Art. No. 4718 120



Holder for Grinding Pads

- Practical device for storage and tear-off of grinding papers on rolls
- Ideal to be used for grinding pads AGR 5945

Article No.	Article Description	QTY
4990 750 16	HOLD. GRIND.PADS W.SH.TROL/PFA	1



Workshop Wagon for PFA / Painter



- Mobile workplace for the professional car worker directly on the vehicle
- Perfect stowage options of all products
- Big working surface
- Can be equipped individually
- Total load capacity: 250 kg
- Drawer load capacity: 30 kg
- Workshop wagon blue (RAL 5003), drawers and lockable compartment anthracite grey (RAL 7016)

Dimensions:

- Workshop wagon PFA (H x W x D): 840 x 1,165 x 440 mm
- 1x drawer small (H x W x D): 75 x 440 x 340 mm
- 1x drawer medium (H x W x D): 155 x 440 x 340 mm
- 1x drawer large (H x W x D): 235 x 440 x 340 mm
- 1x lockable compartment (H x W x D): 515 x 440 x 348 mm
- 2 fixed castors Ø 125 mm
- 2 swivel castors with brakes Ø 125 mm



Article No.	Article Description	QTY
4990 740	WORKSHOP WAGON PFA/PAINTER	1

Scope of delivery:

- Art. No. 4990 750 14: Cleaning cloth roll holder
- Art. No. 4990 750 18: Bin for workshop wagon PFA / painter

Fold-down Step

- Perfect supplement for car and commercial vehicle operations and for professional vehicle conditioners
- Space-saving and non-slip alternative to rigid stepping crates, ladders, etc.
- Solid and stable steel structure
- Resistant to tipping due to the addition of 4-edge tube feet at a 100 degree angle with PVC insert
- Total load bearing capacity: 150 kg
- Teraflex matt black/anthracite with a total thickness of 1.5 mm in compliance with DIN EN 428
- Pressure resistance of the step support as per EN 1516 / = 0.5 mm
- Colour: blue (RAL 5003)

Application:

- For elevated assembly work on the car or commercial vehicle, such as roof antennas, mirrors, wind shield wipers, etc.
- Mobile and flexible usage for vehicle conditioners and bodywork dent removers

Dimensions:

- Height: 270 mm
- Tread (L x B): 300 x 430 mm
- Metal floor thickness: 1.5 mm



Feet Folding and Unfolding Mechanism



1. Step folded



2. Unlock safety locks



3. Unfold feet



4. Lock safety locks

Article No.	Article Description	QTY
4990 125	FOLD-DOWN STEP	1

Your Advantage / Benefit

- Space-saving and non-slip alternative to rigid stepping crates, ladders, etc.
- Solid and stable steel structure
- Slip-resistant, glued-on Teraflex foot mat
- Resistant to tipping due to the addition of 4-edge tube feet at a 100 degree angle with PVC insert

Application

- Particularly suited for professional vehicle conditioning
- For elevated assembly work on the car or commercial vehicle, such as roof antennas, mirrors, wind shield wipers, etc.
- Mobile and flexible usage for vehicle conditioners and bodywork dent removers

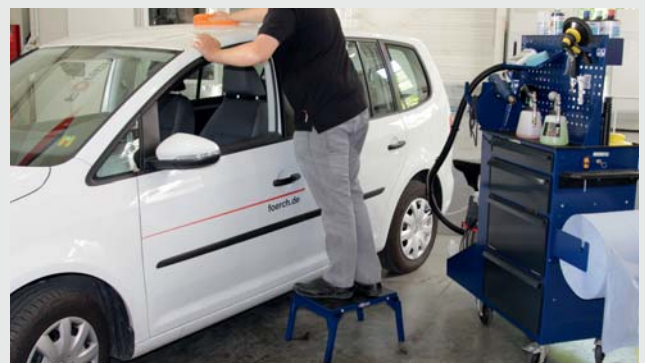

Tool Kit 46-Part



Partition VAROsoft tool deposit:

- 4x VAROsoft tool deposit size A, (B x T): 144 x 328 mm
- 1x VAROsoft tool deposit size A+, (B x T): 144 x 405 mm

Art. No. 4202V 90:

- 7-part in VAROsoft tool deposit Art. No. 9026 313
- AGR 4202: MK screwdriver
LS 0,7 x 3,5 / 0,8 x 4,5 / 1,0 x 5,5 / 1,2 x 7,0
- AGR 4202: MK-PH screwdriver PH 1, PH 2
- Art. No. 4202 14 4: 1/4" square T-handle-ratchet

Art. No. 4584V 013:

- 13-part in VAROsoft tool deposit Art. No. 9026 61
- AGR 4584: ring spanner
SW 8 / 9 / 10 / 11 / 12 / 13 / 14 / 15 / 16 / 17 / 18 / 19 / 21

Art. No. 4415 12 21:

- 21-part in VAROsoft tool deposit
- Art. No. 4401 12 4: fine-toothed ratchet 1/2"
- Art.-Nr. 4420 125: extension square 125 mm
- Art.-Nr. 4420 250: extension square 250 mm
- Art.-Nr. 4407 12: articulation piece
- Art.-Nr. 4402 12: cross slide handle
- AGR 4427: hex socket wrench inserts
SW 8 / 9 / 10 / 11 / 12 / 13 / 14 / 15 / 16 / 17 / 18 / 19 / 20 / 21 / 22 / 24

Art. No. 4099V 03:

- 3-part in VAROsoft tool deposit Art. No. 9026 66
- Art. No. 4010 160: Side cutter 160 mm
- Art. No. 4000 160: Combi pliers 160 mm
- Art.-Nr. 4030 200: Flat-nosed pliers, straight 200 mm

Art. No. 4652V 03:

- 3-part in VAROsoft tool deposit Art. No. 9026 67
- Art. No. 4650 250: Knipex Cobra water pump pliers 250 mm FÖRCH 5*
- Art. No. 4720 400: Engineer's hammer 400 g FÖRCH 5*
- Art. No. 4715 2: Pocket rule

Article No.	Article Description	QTY
4990 2	TOOL KIT 46PART	1

Tool Trolley 661 with 47-Part Tool Kit

- Assembled
- Application example of VAROsoft tool deposit in the drawer of tool trolley 660

VAROsoft A	VAROsoft B	VAROsoft C	VAROsoft C
	VAROsoft B	VAROsoft C	VAROsoft C



Article No.	Article Description	QTY
4990 661 47 0	T.T.BU/GREY W.TOOL KIT 47-PCE	1
4990 661 47 10	T.T.RD/GREY W.TOOL KIT 47-PCE	1
4990 661 47 20	T.T.BK/GREY W.TOOL KIT 47-PCE	1
4990 661 47	T.T.BU/GREY W.TOOL KIT 47-PCE	1
4990 661 47 1	T.T.RD/ANTR.W.TOOL KIT 47-PCE	1
4990 661 47 2	T.T.BK/ANTR.W.TOOL KIT 47-PCE	1

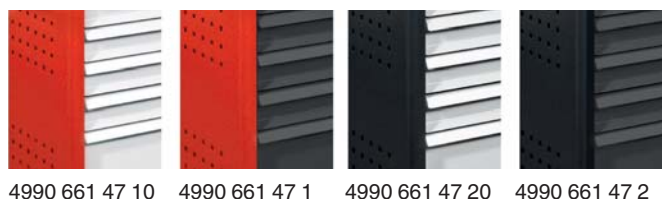

Tool Trolley Pro 861 with 47 Pce. Tool Kit

- Assembled
- Application example of VAROsoft tool deposit in the drawer of tool trolley 861

VAROsoft A+	VAROsoft D	VAROsoft D	VAROsoft D
	VAROsoft A	VAROsoft B	VAROsoft C
		VAROsoft B	VAROsoft C



Article No.	Article Description	QTY
4990 861 47	T.T.861 BU/ANTR.W.T.KIT 47-PCE	1
4990 861 47 1	T.T.861 RD/ANTR.W.T.KIT 47-PCE	1
4990 861 47 2	T.T.861 BK/ANTR.W.T.KIT 47-PCE	1
4990 861 47 0	T.T.861 BLUE WITH T.KIT 47-PCE	1
4990 861 47 10	T.T.861 RED WITH T.KIT 47-PCE	1
4990 861 47 20	T.T.861 BLACK W. T.KIT 47-PCE	1



Tool Kit 98-Part

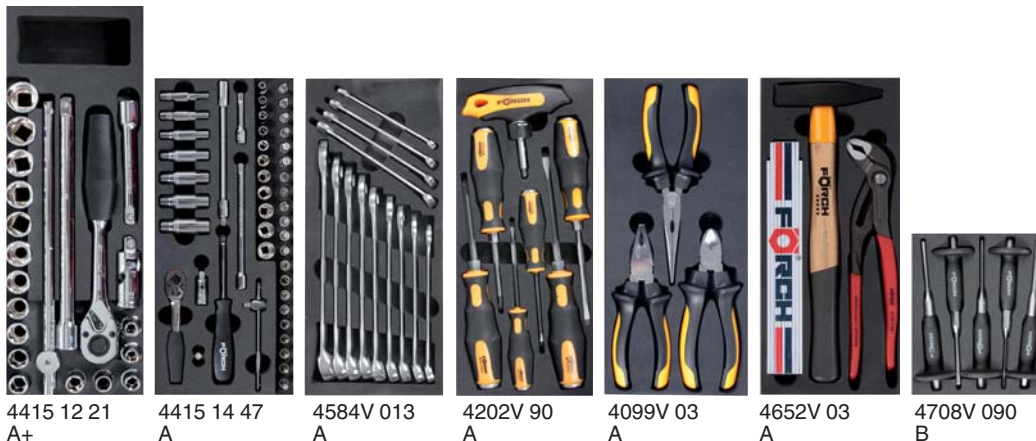

Distribution VS system insert:

- 5x VS system insert size A, (W x D): 144 x 328 mm
- 1x VS system insert size A+, (W x D): 144 x 405 mm
- 1x VS system insert size B, (W x D): 144 x 164 mm

Art. No. 4415 12 21:

- 21-part in VAROsoft tool deposit
- Art. No. 4401 12 4: 1/2" fine-toothed ratchet 250 mm
- Art. No. 4420 125: 1/2" extension square 125 mm
- Art. No. 4420 250 1/2" extension square 250 mm
- Art. No. 4407 12: 1/2" articulation piece 67 mm
- Art. No. 4402 12: 1/2" cross slide handle 300 mm
- AGR 4427: hex socket wrench inserts SW 8 / 9 / 10 / 11 / 12 / 13 / 14 / 15 / 16 / 17 / 18 / 19 / 20 / 21 / 22 / 24

Art. No. 4415 14 47:

- 47-part in VAROsoft tool deposit
- Art. No. 4401 14 4: 1/4" fine-toothed ratchet 110 mm
- Art. No. 4403 141: 1/4" twist handle 150 mm
- Art. No. 4402 14: 1/4" cross slide handle 115 mm
- Art. No. 4407 14: 1/4" articulation piece 39 mm
- Art. No. 4418 50: 1/4" extension square 50 mm
- Art. No. 4418 125: 1/4" extension square 125 mm
- Art. No. 4417 14 150: 1/4" extension square, flexible 150 mm
- Art. No. 4361 14 64: 1/4" adapter hexagonal x 1/4" square
- AGR 4425: Socket wrench inserts, short 25 mm SW 4 / 5 / 5.5 / 6 / 7 / 8 / 9 / 10 / 11 / 12 / 13
- AGR 4425: Socket wrench inserts, long 50 mm SW 6 / 7 / 8 / 10 / 11 / 12 / 13
- AGR 4450: Bit socket wrench inserts-hexagonal SW 3 / 4 / 5 / 6 / 7 / 8
- AGR 4470: Bit socket wrench inserts-cross recessed PH 1 / 2 / 3

- AGR 4471: Bit socket wrench inserts LS 4 / 5
- AGR 4455: Bit socket wrench inserts TX with head drill hole TX 10 / 15 / 20 / 25 / 27 / 30 / 40
- AGR 4462: Bit socket wrench inserts, multi-tooth M5 / M6 / M8

Art. No. 4584V 013:

- 13-part in VAROsoft tool deposit Art. No. 9026 61
- AGR 4584: ring spanner SW 8 / 10 / 11 / 12 / 13 / 14 / 15 / 16 / 17 / 18 / 19 / 21

Art. No. 4202V 90:

- 7-part in VAROsoft tool deposit Art. No. 9026 613
- AGR 4202: MK screwdriver LS 0.7 x 3.5 / 0.8 x 4.5 / 1.0 x 5.5 / 1.2 x 7.0
- AGR 4202: MK-PH screwdriver PH 1, PH 2
- Art. No. 4202 14 4: 1/4" square T-handle ratchet

Art. No. 4099V 03:

- 3-part in VAROsoft tool deposit Art. No. 9026 66
- Art. No. 4010 160: Side cutter 160 mm
- Art. No. 4000 160: Combi pliers 160 mm
- Art. No. 4030 200: Flat-nosed pliers, straight 200 mm

Art. No. 4652V 03:

- 3-part in VAROsoft tool deposit Art. No. 9026 67
- Art. No. 4650 250: Knipex Cobra water pump pliers 250 mm FÖRCH 5*
- Art. No. 4720 400: Engineer's hammer 400 g FÖRCH 5*
- Art. No. 4715 2: Pocket rule 2 m

Art. No. 4708V 090:

- 5-part in VAROsoft tool deposit Art. No. 9026 85
- AGR 4708: Pin punch 3 / 4 / 5 / 6 / 8

Article No.	Article Description	QTY
4990 6	TOOL-KIT 99-PART	1

Tool Trolley 861 STRONG with 99-part Tool Kit

- Assembled
- Application example for the VAROsoft tool deposit in the drawer of the tool trolley 861

VAROsoft A+	VAROsoft D	VAROsoft D	VAROsoft D	
	VAROsoft A	VAROsoft B	VAROsoft C	VAROsoft C
		VAROsoft B	VAROsoft C	VAROsoft C



Article No.	Article Description	QTY
4990 861 99	T.T.861 BU/ANTR.W.T.KIT 99PCE	1
4990 861 99 1	T.T.861 RD/ANTR.W.T.KIT 99PCE	1
4990 861 99 2	T.T.861 BK/ANTR.W.T.KIT 99PCE	1
4990 861 99 0	T.T.861 BLUE W.T.KIT 99PCE	1
4990 861 99 10	T.T.861 RED W.T.KIT 99PCE	1
4990 861 99 20	T.T.861 BLACK W.T.KIT 99PCE	1



4990 861 99 10 4990 861 99 1 4990 861 99 20 4990 861 99 2

Tool Kit 186-Part



4415 12 25 A+ 4430 58 A+



4159 20 9026 60 A 4427V 015 A 4652V 03 A 4099V 03 A 4415 14 47 A 4628V 91 A 4202V 90 A 4586V 7 B 4708V 090 B

Distribution VS system insert:

- 2x VS system insert A+, (W x D): 144 x 405 mm
- 7x VS system insert A, (W x D): 144 x 328 mm
- 2x VS system insert B, (W x D): 144 x 164 mm

Art. No. 4427V 015:

- 10-part in VAROsoft system insert Art. No. 9026 68
- AGR 4427: 1/2" hex socket wrench insert, long SW 10 / 11 / 12 / 13 / 14 / 15 / 16 / 17 / 18 / 19

Art. No. 4415 14 47:

- 47-part in VAROsoft system insert Art. No. 9026 63
- Art. No. 4401 14 36: 1/4" lever switch ratchet 100 mm
- Art. No. 4403 141: 1/4" twist handle 150 mm
- Art. No. 4402 14: 1/4" cross slide handle 115 mm
- Art. No. 4407 14: 1/4" articulation piece 39 mm
- Art. No. 4418 50: 1/4" extension square 50 mm
- Art. No. 4418 125: 1/4" extension square 125 mm
- Art. No. 4417 14 150: 1/4" extension square, flexible 150 mm
- Art. No. 4361 14 64: 1/4" adapter hexagonal x 1/4" square
- AGR 4425: Socket wrench inserts, short 25 mm SW 4 / 5 / 5.5 / 6 / 7 / 8 / 9 / 10 / 11 / 12 / 13
- AGR 4425: Socket wrench inserts, long 50 mm SW 6 / 7 / 8 / 10 / 11 / 12 / 13
- AGR 4450: Bit hex socket wrench inserts SW 3 / 4 / 5 / 6 / 7 / 8
- AGR 4470: Bit cross recessed socket wrench inserts PH 1 / 2 / 3
- AGR 4471: Bit slotted socket wrench inserts 4 / 5
- AGR 4455: Bit socket wrench insert TX with drilled hole TX 10 / 15 / 20 / 25 / 27 / 30 / 40
- AGR 4462: Bit socket wrench inserts-multitooth M5 / M6 / M8

Art. No. 4415 12 25:

- 25-part in VAROsoft tool deposit Art. No. 9026 71
- Art. No. 4401 12 36: 1/2" lever switch ratchet 250 mm
- Art. No. 4420 125: 1/2" extension square 125 mm
- Art. No. 4420 250: 1/2" extension square 250 mm
- Art. No. 4407 12: 1/2" articulation piece 67 mm
- Art. No. 4402 12: 1/2" cross slide handle 300 mm
- AGR 4427: Hex socket wrench inserts SW 8 / 9 / 10 / 11 / 12 / 13 / 14 / 15 / 16 / 17 / 18 / 19 / 20 / 21 / 22 / 24 / 27 / 30 / 32 / 34

Art. No. 4430 58:

- 58-part in VAROsoft system insert Art. No. 9026 76
- AGR 4440: Insert 1/4"-drive TX E4, E5, E6, E7, E8
- AGR 4442: Insert 1/2"-drive TX E10, E11, E12, E14, E16, E18, E20
- AGR 4320: Special-Bit TX-long TX 20/25/27/30/40/45/50/55/60
- AGR 4320: Special-Bit TX-short with face drilling TX 20/25/27/30/40/45/50/55/60

- AGR 4322: Internal serration bit, short XZN 5/6/8/10/12
- AGR 4322: Internal serration bit, long XZN 6/8/10/12
- AGR 4323: Hex bit, short SW 4/5/6/7/8/10/12
- AGR 4323: Hex bit, long SW 5/6/7/8/10
- AGR 4324: Slotted bit, short LS 8/10
- AGR 4325: Recessed bit, short PH 2/3
- Art. No. 4361 12 10: 1/2" Bit adapter 10 mm
- Art. No. 4401 10: 10 mm bit ratchet, length 112 mm

Art. No. 4628V 91:

- 12-part in VAROsoft system insert Art. No. 9026 61
- AGR 4628: ring spanner SW 8 / 9 / 10 / 11 / 12 / 13 / 14 / 15 / 16 / 17 / 18 / 19

Art. No. 4586V 7:

- 7-part in VAROsoft system insert Art. No. 9026 87
- AGR 4586: mini ring spanner set SW 10 / 11 / 12 / 13 / 14 / 17 / 19

Art. No. 4708V 090:

- 5-part in VAROsoft system insert Art. No. 9026 85
- AGR 4708: pin punch 3 / 4 / 5 / 6 / 8

Art. No. 4159 20:

- 9-part in VAROsoft system insert Art. No. 9026 60
- Hex-Plus-spanner set

Art. No. 9026 60:

- VAROsoft system insert, empty

Art. No. 4652V 03:

- 3-part in VAROsoft system insert Art. No. 9026 67
- Art. No. 4650 250: Knipex Cobra water pump pliers 250 mm FÖRCH 5*
- Art. No. 4720 400: Engineer's hammer 400 g FÖRCH 5*
- Art. No. 4715 2: Pocket rule 2 m

Art. No. 4099V 03:

- 3-part in VAROsoft system insert Art. No. 9026 66
- Art. No. 4010 160: side cutter 160 mm
- Art. No. 4000 160: combi pliers 160 mm
- Art. No. 4030 200: flat-nosed pliers, straight 200 mm

Art. No. 4202V 90:

- 7-part in VAROsoft system insert Art. No. 9026 613
- AGR 4202: MK screwdriver LS 0.7 x 3.5 / 0.8 x 4.5 / 1.0 x 5.5 / 1.2 x 7.0
- AGR 4202: MK-PH screwdriver PH 1, PH 2
- Art. No. 4202 14 4: 1/4" square T-handle ratchet

Article No.	Article Description	QTY
4990 7	TOOL-KIT PROFI 186 PART	1

Tool Trolley 861 STRONG with 186 Pce. Tool Kit

- Assembled
- Application example for the VAROsoft system insert in the drawer of the tool trolley 861



VAROsoft A+	VAROsoft D	VAROsoft D	VAROsoft D	
	VAROsoft A	VAROsoft B	VAROsoft C	VAROsoft C
		VAROsoft B	VAROsoft C	VAROsoft C

Article No.	Article Description	QTY
4990 861 186	T.T.861 BU/ANTR.W.T.KIT 186PCE	1
4990 861 186 1	T.T.861 RD/ANTR.W.T.KIT 186PCE	1
4990 861 186 2	T.T.861 BK/ANTR.W.T.KIT 186PCE	1
4990 861 186 0	T.T.861 BLUE W.TOOL KIT 186PCE	1
4990 861 186 10	T.T.861 RED W.TOOL KIT 186PCE	1
4990 861 186 20	T.T.861 BLACK W.T.KIT 186PCE	1

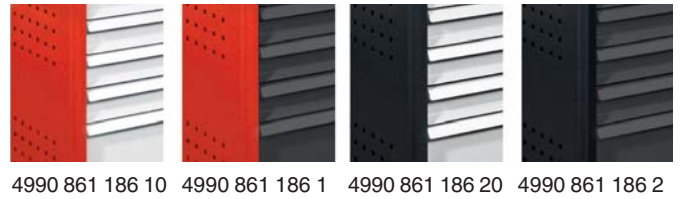

Tool Kit 260 Pcs.

4430 58
A+4415 12 21 1
A+4715 160
4708 30
A+4571 12 90
4x D4159 20
4940 1
4x D4584V 5
A+4099V 04 5
A+4415 38 19
A4415 14 33
A4413V 007
A4413V 010
A4457V 013
A4452V 014
A4580V 010
2x A4584V 013
A4209V 1
A4259V 1
A4628V 91
A4652V 03 5
A4751 95
A4670 2
4670 12
A

Distribution VS system:

- 2x VAROsoft system insert 4x D, (W x D): 576 x 77 mm
- 4x VAROsoft system insert A+, (W x D): 144 x 405 mm
- 16x VAROsoft system insert A, (W x D): 144 x 328 mm
- 8x VAROsoft system insert D, (W x D): 144 x 77 mm

Art. No. 4430 58:

- 57-piece in VAROsoft system insert Art. No. 9026 76
- AGR 4440: Insert 1/4" drive TX E4, E5, E6, E7, E8
- AGR 4442: Insert 1/2" drive TX E10, E11, E12, E14, E16, E18, E20
- AGR 4320: Special bit TX long TX 20 / 25 / 27 / 30 / 40 / 45 / 50 / 55 / 60
- AGR 4320: Special bit TX short with face hole TX 20 / 25 / 27 / 30 / 40 / 45 / 50 / 55 / 60
- AGR 4322: Internal serration bit long XZN 6 / 8 / 10 / 12
- AGR 4322: Internal serration bit short XZN 5 / 6 / 8 / 10 / 12
- AGR 4323: Internal serration bit long SW 5 / 6 / 7 / 8 / 10
- AGR 4323: Internal serration bit short SW 4 / 5 / 6 / 7 / 8 / 10 / 12
- AGR 4324: Slot bit short LS 8 / 10
- AGR 4325: Recessed head bit short PH 2 / 3
- Art. No. 4361 12 10: 1/2" bit adapter 10 mm
- Art. No. 4401 10: 10 mm bit ratchet length 112 mm

Art. No. 4415 38 19:

- 19-piece in VAROsoft system insert Art. No. 9026 633
- Art. No. 4401 38 30 50: 3/8" lever wrench 30 Z. FÖRCH 5*
- Art. No. 4407 38 50: 3/8" joint piece FÖRCH 5*, 50 mm
- Art. No. 4419 125 50: 3/8" extension 4-edge FÖRCH 5*, 125 mm
- Art. No. 4419250 50: 3/8" extension 4-edge FÖRCH 5*, 250mm
- AGR 4426... 50: 3/8" socket wrenches FÖRCH 5*, 29 mm SW 8 / 9 / 10 / 11 / 12 / 13 / 14 / 15 / 16 / 17 / 18 / 19 / 21 / 22 / 24

Art. No. 4415 14 33:

- 33-piece in VAROsoft system insert Art. No. 9026 632
- Art. No. 4401 14 20 50: 1/4" lever wrench 20 Z. FÖRCH 5*
- Art. No. 4418 75 50: 1/4" extension 4-edge FÖRCH 5*, 75 mm
- Art. No. 4418150 50: 1/4" extension 4-edge FÖRCH 5*, 150 mm
- Art. No. 4407 14 50: 1/4" joint piece FÖRCH 5*, 35 mm
- AGR 4471...50: 1/4" LS impact wrench FÖRCH 5* 3.5 / 5.5
- AGR 4470...50: 1/4" PH-impact wrench FÖRCH 5* 1/2
- AGR 4455...50: 1/4" TX-impact wrenches FÖRCH5* 8 / 9 / 10 / 15 / 20 / 25 / 27 / 30 / 40
- AGR 4450...50: 1/4" interior 6-edge-impact wrenches FÖRCH 5* 3 / 4 / 5 / 6 / 8
- AGR 4425...50: 1/4" 6-edge impact wrenches FÖRCH 5*, 23 mm SW 4 / 5 / 5.5 / 6 / 7 / 8 / 9 / 10 / 11 / 12 / 13

Art. No. 4415 12 21 1:

- 21-piece in VAROsoft system insert Art. No. 9026 729
- Art. No. 4401 12 32 50: 1/2" lever wrench 32 Z. FÖRCH 5*
- Art. No. 4407 12 50: 1/2" joint piece 69 mm, FÖRCH 5*
- Art. No. 4420 125 50 1/2" extension 4-edge 125 mm, FÖRCH 5*
- Art. No. 4420 250 50 1/2" extension 4-edge 250 mm, FÖRCH 5*
- AGR 4427... 50 1/2" 6-edge impact wrenches 37 mm, FÖRCH 5* SW 10 / 11 / 12 / 13 / 14 / 15 / 16 / 17 / 18 / 19 / 20 / 21 / 22 / 24 / 27 / 30 / 32

Art. No. 4571 12 90:

- 1/2" impact socket wrench 86 mmSW 17 blue
- 1/2" impact socket wrench 86 mmSW 19 yellow
- 1/2" impact socket wrench 86 mm SW 21 red

Art. No. 4413V 007:

- 7-piece in VAROsoft system insert Art. No. 9026 621
- each 1x AGR 4413 socket wrench 1/2" SW 20 / 21 / 22 / 24 / 27 / 30 / 32

Art. No. 4413V 010:

- 10-piece in VAROsoft system insert Art. No. 9026 628
- each 1x AGR 4413 socket wrench 1/2" SW 10 / 11 / 12 / 13 / 14 / 15 / 16 / 17 / 18 / 19

Art. No. 4457V 013:

- 13-piece in VAROsoftsystem Art. No. 9026 623
- AGR 4457: TX 1/2" short: TX 20 / 25 / 27 / 30 / 40 / 45 / 50 / 55 / 60
- AGR 4457: TX 1/2" long: TX 40 / 45 / 50 / 60

Art. No. 4452V 014:

- 14-piece in VAROsoft system insert Art. No. 9026 622
- AGR 4452: I-6 edge 1/2" short: 5 / 6 / 7 / 8 / 10 / 12 / 14 / 17 / 19
- AGR 4452: I-6 edge 1/2" long: 5 / 6 / 7 / 8 / 10

Art. No. 4580V 010:

- 10-piece in VAROsoft system insert Art. No. 9026 111
- AGR 4580: open-end wrench SW 6 x 7 / 8 x 9 / 10 x 11 / 12 x 13 / 14 x 15 / 16 x 17 / 18 x 19 / 20 x 22 / 24 x 27 / 30 x 32

Art. No. 4584V 013:

- 13-piece in VAROsoft system insert Art. No. 9026 631
- AGR 4584: angled combination wrench SW 8 / 9 / 10 / 11 / 12 / 13 / 14 / 15 / 16 / 17 / 18 / 19 / 21

Art. No. 4584V 5:

- 5-piece in VAROsoft system insert Art. No. 9026 720

(Continued on next page)

- AGR 4584: angled combination wrench SW 22 / 24 / 27 / 30 / 32
- Art. No. 4159 20:**
- Hex-Plus Allen wrench set
- 9-piece
- With spherical head SW 1.5 / 2 / 2.5 / 3 / 4 / 5 / 6 / 8 / 10
- Art. No. 4940 1:**
- Steel brake calliper brushes
- To clean brake callipers made from cast steel
- Art. No. 4209V 1:**
- 6-piece in VAROsoft system insert Art. No. 9026 62
- AGR 4200: MK screwdriver DG. KL. LS 3.5 / 4.5 / 5.5 / 7
- AGR 4205: MK screwdriver DG. KL. PH 1/2
- Art. No. 4259V 1:**
- 6-piece in VAROsoft system insert Art. No. 9026 62
- each 1x TX 10 / 15 / 20 / 25 / 30 / 40
- Art. No. 4628V 91:**
- 12-piece in VAROsoft system insert Art. No. 9026 61
- each 1x SW 8 / 9 / 10 / 11 / 12 / 13 / 14 / 15 / 16 / 17 / 18 / 19
- Art. No. 4715 160:**
- In plastic case
- Pocket calliper gauge 150 mm
- Art. No. 4708 30:**
- 6-piece in stand

- Each 1x AGR 4708: pin punch, 150 mm Ø 2 / 3 / 4 / 5 / 6 / 8 mm
- Art. No. 4099V 04 5:**
- 4-piece in VAROsoft system insert Art. No. 9026 724 1
- Art. No. 4000 180: Universal pliers 180 mm
- Art. No. 4010 180: Wire cutter 180 mm
- Art. No. 4030 200: Round-nose pliers straight 200 mm
- Art. No. 4040 200: Round-nose pliers bent 200 mm
- Art. No. 4652V 03 5:**
- 3-piece in VAROsoft system insert Art. No. 9026 67 1
- Art. No. 4650 250: Knipex Cobra water pump pliers 250 mm
- Art. No. 4720 400: Machinist's hammer 400 g FÖRCH 5*
- Art. No. 4715 2: Pocket rule 2 m
- Art. No. 4751 95:**
- 5-piece in VAROsoft system insert Art. No. 9026 612
- Art. No. 4751 21: Stainless steel pliers 60 x 20 x 1.2 x 190 mm
- Art. No. 4751 22: Stainless steel pliers 60 x 20 x 2.5 x 190 mm
- Art. No. 4751 23: Stainless steel pliers 100 x 32 x 1.2 x 230 mm
- Art. No. 4751 24: Stainless steel pliers 100 x 32 x 2.5 x 230 mm
- Art. No. 4751 25: ASK stainless steel cutter 210 mm
- Art. No. 4670 2:**
- 1x long-nose grip pliers 6LN 150 mm
- Art. No. 4670 12:**
- 1x long-nose grip pliers 10WR 220 mm

Article No.	Article Description	QTY
4990 260	TOOL KIT SET 260 PIECES	1

Tool Trolley 861 STRONG with 260 Pce. Tool Kit

- Assembled
- Example for use of the VAROsoft system insert in the drawer of the tool trolley 861

VAROsoft A+	VAROsoft D	VAROsoft D	VAROsoft D
	VAROsoft A	VAROsoft B	VAROsoft C
		VAROsoft B	VAROsoft C



Article No.	Article Description	QTY
4990 861 260	T.T.861 BU/ANTR.W.T.KIT 260PCE	1
4990 861 260 1	T.T.861 RD/ANTR.W.T.KIT 260PCE	1
4990 861 260 2	T.T.861 BK/ANTR.W.T.KIT 260PCE	1
4990 861 260 0	T.T.861 BLUE W.TOOL KIT 260PCE	1
4990 861 260 10	T.T.861 RED W.TOOL KIT 260PCE	1
4990 861 260 20	T.T.861 BLACK W.T.KIT 260PCE	1

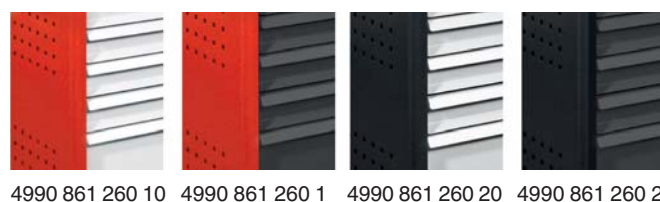

Tool Kit 194-part **FÖRCH*******



4990 179 40 1 / 4990 861 40 1



4990 179 40 2 / 4990 861 40 2



4990 179 40 3 / 4990 861 40 3



4990 179 40 4 / 4990 861 40 4

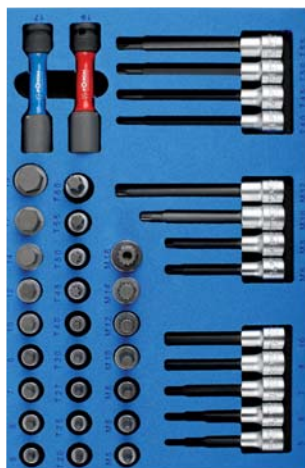

4990 179 40 5 / 4990 861 40 5



4990 179 40 6 / 4990 861 40 6



4990 179 40 7 / 4990 861 40 7



4990 179 40 8 / 4990 861 40 8

Art. No. 4990 179 40 1:

- In VAROsoft system insert Art. No. 9026 179 1 1
- 20 pieces

Contents:

Article No.	Article Description	Quantity
4159 20	HEX-PLUS BP ALLEN KEY SET 9-PA	1
4200 35	MC-SCREWDRIV.PASS.BL. 3.5 5*	1
4200 45	MC-SCREWDRIV.PASS.BL.4.5 5*	1
4200 55	MC-SCREWDRIV.PASS.BL.5.5 5*	1
4200 7	MC-SCREWDRIV.PASS.BL.7 5*	1
4200 10	MC-SCREWDRIV.PASS.BL.10 5*	1
4201 1	MC SCREWDR.PH 1 PASS BLADE 5*	1
4201 2	MC SCREWDR.PH 2 PASS BLADE 5*	1
4201 3	MC SCREWDR.PH 3 PASS.BLADE 5*	1
4223 25	SCREWDRIVER STANDARD LS 2.5	1
4224 55	SCREWDRIVER SHORT 5.5	1
4226 2	PH-SCREWDRIVER SHORT 2	1

Art. No. 4990 179 40 2:

- In VAROsoft system insert Art. No. 9026 179 1 2
- 18 pieces

Contents:

Article No.	Article Description	Quantity
3295 6 50	SCR.DRIVER HEX FLEX.W.AF6 5*	1
3295 7 50	SCR.DRI.6-EDGE FLEX.W.AF7 5*	1
3295 8 50	SCR.DRIVER HEX FLEX.W.AF8 5*	1
4149 5	BALLPOINT-TX-ALLEN WR.CLIP 9P.	1
4251 10	TX SCREWDRIVER MC-HANDLE TX 10	1
4251 15	TX SCREWDRIVER MC-HANDLE TX 15	1
4251 20	TX SCREWDRIVER MC-HANDLE TX 20	1
4251 25	TX SCREWDRIVER MC-HANDLE TX 25	1
4251 30	TX SCREWDRIVER MC-HANDLE TX 30	1
4251 40	TX SCREWDRIVER MC-HANDLE TX 40	1

Art. No. 4990 179 40 3:

- In VAROsoft system insert Art. No. 9026 179 1 3
- 23 pieces

Contents:

Article No.	Article Description	Quantity
4582 6 7	DOUBLE RING SPANNER OFFSET 6X7	1
4582 8 9	DOUBLE RING SPANNER OFFSET 8X9	1
4582 10 11	DOUBLE RING SPANN.OFFSET 10X11	1
4582 12 13	DOUBLE RING SPANN.OFFSET 12X13	1
4582 14 15	DOUBLE RING SPANN.OFFSET 14X15	1
4582 16 17	DOUBLE RING SPANN.OFFSET 16X17	1
4582 18 19	DOUBLE RING SPANN.OFFSET 18X19	1
4584 6	COMBINATION SPANNER ANGLED 6	1
4584 7	COMBINATION SPANNER ANGLED 7	1
4584 8	COMBINATION SPANNER ANGLED 8	1
4584 9	COMBINATION SPANNER ANGLED 9	1
4584 10	COMBINATION SPANNER ANGLED 10	1
4584 11	COMBINATION SPANNER ANGLED 11	1
4584 12	COMBINATION SPANNER ANGLED 12	1
4584 13	COMBINATION SPANNER ANGLED 13	1
4584 14	COMBINATION SPANNER ANGLED 14	1
4584 15	COMBINATION SPANNER ANGLED 15	1
4584 16	COMBINATION SPANNER ANGLED 16	1
4584 17	COMBINATION SPANNER ANGLED 17	1
4584 18	COMBINATION SPANNER ANGLED 18	1
4584 19	COMBINATION SPANNER ANGLED 19	1
4584 21	COMBINATION SPANNER ANGLED 21	1
4920 50	UNION NUT SPANNER W.PLATE10X11	1

(Continued on next page)



Tool Kit 194-part **FÖRCH*******

Art. No. 4990 179 40 2:

• In VAROsoft system insert Art. No. 9026 179 1 4

• 8 pieces

Contents:

Article No.	Article Description	Quantity
4582 20 22	DOUBLE RING SPANN.OFFSET 20X22	1
4582 24 27	DOUBLE RING SPANN.OFFSET 24X27	1
4582 30 32	DOUBLE RING SPANN.OFFSET 30X32	1
4584 22	COMBINATION SPANNER ANGLED 22	1
4584 24	COMBINATION SPANNER ANGLED 24	1
4584 27	COMBINATION SPANNER ANGLED 27	1
4584 30	COMBINATION SPANNER ANGLED 30	1
4584 32	COMBINATION SPANNER ANGLED 32	1

Art. No. 4990 179 40 5:

• In VAROsoft system insert Art. No. 9026 179 1 5

• 38 pieces

Contents:

Article No.	Article Description	Quantity
4452 5 50	1/2"HEX SCREWDR. BIT 5 50MM 5*	1
4452 5 100 50	1/2"HEX SCREWDR. BIT 5 100MM 5*	1
4452 6 50	1/2"HEX SCREWDR. BIT 6 50MM 5*	1
4452 6 100 50	1/2"HEX SCREWDR. BIT6 100MM 5*	1
4452 7 50	1/2"HEX SCREWDR. BIT 7 50MM 5*	1
4452 7 100 50	1/2"HEX SCREWDR. BIT7 100MM 5*	1
4452 8 50	1/2"HEX SCREWDR. BIT 8 50MM 5*	1
4452 8 100 50	1/2"HEX SCREWDR. BIT8 100MM 5*	1
4452 10 50	1/2"HEX SCREWDR. BIT10 50MM 5*	1
4452 10 100 50	1/2"HEX SCREWDR. BIT10 100MM5*	1
4452 12 50	1/2"HEX SCREWDR. BIT12 50MM 5*	1
4452 14 50	1/2"HEX SCREWDR. BIT14 50MM 5*	1
4452 17 50	1/2"HEX SCREWDR. BIT17 50MM 5*	1
4452 19 50	1/2"HEX SCREWDR. BIT19 50MM 5*	1
4457 20 50	1/2"TX SCREWDR. BIT 20 60MM 5*	1
4457 25 50	1/2"TX SCREWDR. BIT 25 60MM 5*	1
4457 27 50	1/2"TX SCREWDR. BIT 27 60MM 5*	1
4457 30 50	1/2"TX SCREWDR. BIT 30 60MM 5*	1
4457 40 50	1/2"TX SCREWDR. BIT 40 60MM 5*	1
4457 40 140 50	1/2"TX SCREWDR. BIT40 140MM 5*	1
4457 45 50	1/2"TX SCREWDR. BIT 45 60MM 5*	1
4457 45 140 50	1/2"TX SCREWDR. BIT45 140MM 5*	1
4457 50 50	1/2"TX SCREWDR. BIT 50 60MM 5*	1
4457 50 140 50	1/2"TX SCREWDR. BIT 50 140MM 5*	1
4457 55 50	1/2"TX-SCHR-DR.EIN.55 60MM 5*	1
4457 55 140 50	1/2"TX SCREWDR. BIT55 140MM 5*	1
4457 60 50	1/2" TX-SCR.DR.IN 60MM 5*	1
4460 5 50	1/2"XZN SCREWDR. BIT 5 60MM 5*	1
4460 6 50	1/2"XZN SCREWDR. BIT 6 60MM 5*	1
4460 6 100 50	1/2"XZN SCREWDR. BIT 6 100MM 5*	1
4460 8 50	1/2"XZN SCREWDR. BIT 8 60MM 5*	1
4460 8 100 50	1/2"XZN SCREWDR. BIT8 100MM 5*	1
4460 10 50	1/2"XZN SCREWDR. BIT10 60MM 5*	1
4460 10 120 50	1/2"XZN SCREWDR. BIT 10 120MM5*	1
4460 12 50	1/2"XZN SCREWDR. BIT12 60MM 5*	1
4460 12 140 50	1/2"XZN SCREWDR. BIT12 140MM 5*	1
4460 14 50	1/2"XZN SCREWDR. BIT 14 60MM 5*	1
4460 16 50	1/2"XZN SCR.DR. BIT16 60MM 5*	1
4571 12 17 50	1/2"KRAF-SO.WR.SW17 BLU110MM5*	1
4571 12 19 50	1/2"KRAF-SO.WR.SW19 RED110MM5*	1

Art. No. 4990 179 40 7:

• In VAROsoft system insert Art. No. 9026 179 1 7

• 11 pieces

Contents:

Article No.	Article Description	Quantity
4701 13	FLAT CHISEL DIN 6453 13X150MM	1
4703 6	WEDGE CHISEL DIN 6451 6X150MM	1
4704 10	CENTRE PUNCH DIN 7250 120X10MM	1
4708 02 1	PIN PUNCH W.HAND PROTEC.2MM 5*	1
4708 04 1	PIN PUNCH W.HAND PROTEC.4MM 5*	1
4708 05 1	PIN PUNCH W.HAND PROTEC.5MM 5*	1
4708 06 1	PIN PUNCH W.HAND PROTEC.6MM 5*	1
4708 08 1	PIN PUNCH W.HAND PROTEC.8MM 5*	1
4762 9 1	CUTTING KNIFE 9MM W.CL.WHEEL	1
4720 5 800	ENGINEER HAMMER DIN 800G 5*	1
4720 5 400	ENGINEER HAMMER DIN 400G 5*	1

Art. No. 4990 179 40 6:

• In VAROsoft system insert Art. No. 9026 179 1 6

• 67 pieces

Contents:

Article No.	Article Description	Quantity
4361 14 64	ADAPTER 1/4"HEXAGON 1/4"SQUARE	1

Contents:

Article No.	Article Description	Quantity
4401 12 32 50	1/2"REVERSIBLE RATCHET 32T 5*	1
4401 14 20 50	1/4"REVERSIBLE RATCHET 20T 5*	1
4402 14 50	1/4" T-HANDLE 115MM 5*	1
4404 28 50	1/4" ANGLE EXTENSION 28MM 5*	1
4404 50 50	1/4" ANGLE EXTENSION 50MM 5*	1
4404 100 50	1/4" ANGLE EXTENSION 100MM 5*	1
4406 125 50	1/2" ANGLE EXTENSION 125MM 5*	1
4406 250 50	1/2" ANGLE EXTENSION 250MM 5*	1
4407 12 50	1/2" ARTICULATION PIECE 5*	1
4407 14 50	1/4" ARTICULATION PIECE 5*	1
4425 4 50	1/4"HEX SOCK.INS.5* SW 4 23MM	1
4425 4 50 50	1/4"HEX SOCK.INS.5* SW 4 50MM	1
4425 5 50	1/4"HEX SOCK.INS.5* SW 5 23MM	1
4425 5 50 50	1/4"HEX SOCK.INS.5* SW 5 50MM	1
4425 6 50	1/4"HEX SOCK.INS.5* SW 6 23MM	1
4425 6 50 50	1/4"HEX SOCK.INS.5* SW 6 50MM	1
4425 7 50	1/4"HEX SOCK.INS.5* SW 7 23MM	1
4425 7 50 50	1/4"HEX SOCK.INS.5* SW 7 50MM	1
4425 8 50	1/4"HEX SOCK.INS.5* SW 8 23MM	1
4425 8 50 50	1/4"HEX SOCK.INS.5* SW 8 50MM	1
4425 9 50	1/4"HEX SOCK.INS.5* SW 9 23MM	1
4425 9 50 50	1/4"HEX SOCK.INS.5* SW 9 50MM	1
4425 10 50	1/4"HEX SOCK.INS.5* SW10 23MM	1
4425 10 50 50	1/4"HEX SOCK.INS.5* SW10 50MM	1
4425 11 50	1/4"HEX SOCK.INS.5* SW11 23MM	1
4425 11 50 50	1/4"HEX SOCK.INS.5* SW11 50MM	1
4425 12 50	1/4"HEX SOCK.INS.5* SW12 23MM	1
4425 12 50 50	1/4"HEX SOCK.INS.5* SW12 50MM	1
4425 13 50	1/4"HEX SOCK.INS.5* SW13 23MM	1
4425 13 50 50	1/4"HEX SOCK.INS.5* SW13 50MM	1
4427 10 50	1/2"HEX SO.WR.INS.5* SW10 37MM	1
4427 11 50	1/2"HEX SO.WR.INS.5* SW11 37MM	1
4427 12 50	1/2"HEX SO.WR.INS.5* SW12 37MM	1
4427 13 50	1/2"HEX SO.WR.INS.5* SW13 37MM	1
4427 14 50	1/2"HEX SO.WR.INS.5* SW14 37MM	1
4427 15 50	1/2"HEX SO.WR.INS.5* SW15 37MM	1
4427 16 50	1/2"HEX SO.WR.INS.5* SW16 37MM	1
4427 17 50	1/2"HEX SO.WR.INS.5* SW17 37MM	1
4427 18 50	1/2"HEX SO.WR.INS.5* SW18 37MM	1
4427 19 50	1/2"HEX SO.WR.INS.5* SW19 37MM	1
4427 20 50	1/2"HEX SO.WR.INS.5* SW20 37MM	1
4427 21 50	1/2"HEX SO.WR.INS.5* SW21 37MM	1
4427 22 50	1/2"HEX SO.WR.INS.5* SW22 37MM	1
4427 24 50	1/2"HEX SO.WR.INS.5* SW24 37MM	1
4427 27 50	1/2"HEX SO.WR.INS.5* SW27 40MM	1
4427 30 50	1/2"HEX SO.WR.INS.5* SW30 42MM	1
4427 32 50	1/2"HEX SO.WR.INS.5* SW32 42MM	1
4450 3 25 50	1/4"HEX.SCREW.DR.BIT 3 25MM 5*	1
4450 4 25 50	1/4"HEX SCREW.DR.BIT 4 25MM 5*	1
4450 5 25 50	1/4"HEX SCREW.DR.BIT 5 25MM 5*	1
4450 6 25 50	1/4"HEX SCREW.DR.BIT 6 25MM 5*	1
4450 7 25 50	1/4"HEX SCREW.DR.BIT 7 25MM 5*	1
4450 8 25 50	1/4"HEX SCREW.DR.BIT 8 25MM 5*	1
4450 10 25 50	1/4"HEX SCREW.DR.BIT10 25MM 5*	1
4455 10 28 50	1/4"TX-SCREWDRIV.BIT10 28MM 5*	1
4455 15 28 50	1/4"TX-SCREWDRIV.BIT15 28MM 5*	1
4455 20 28 50	1/4"TX-SCREWDRIV.BIT20 28MM 5*	1
4455 25 28 50	1/4"TX-SCREWDRIV.BIT25 28MM 5*	1
4455 27 28 50	1/4"TX-SCREWDRIV.BIT27 28MM 5*	1
4455 30 28 50	1/4"TX-SCREWDRIV.BIT30 28MM 5*	1
4455 40 28 50	1/4"TX-SCREWDRIV.BIT40 28MM 5*	1
4462 5 50	1/4" XZN-SCREWDR. BIT 5 28MM 5*	1
4462 6 50	1/4" XZN-SCREWDR. BIT 6 28MM 5*	1
4462 8 50	1/4" XZN-SCREWDR. BIT 8 28MM 5*	1
4470 1 28 50	1/4"PH SCREWDR. BIT 1 28MM 5*	1
4470 2 28 50	1/4"PH-SCREWDR. BIT 2 28MM 5*	1

Art. No. 4990 179 40 8:

• In VAROsoft system insert Art. No. 9026 179 1 8

• 7 pieces

Contents:

Article No.	Article Description	Quantity
4000 180 5	COMBI-PLIERS 180MM 5*	1
4010 180 5	SIDE CUTTER 180MM 5*	1
4030 205 5	FLAT-NOS.PLIERS STRAI.205MM 5*	1
4040 205 5	FLAT-NOS.PLIERS ANGL.205MM 5*	1
4650 180	KNIP.COBRA WAPO.PLIERS180MM 5*	1
4650 250	KNIP.COBRA WAPO.PLIERS250MM 5*	1
4920 11 1	SPRING WIRE-CLAMP PLIERS	1

Article No.	Article Description	QTY
4990 179 40	TOOL KIT 194-PART 5*	1
4990 861 40	TOOL KIT/194-PART FOR 861 5*	1

Tool Trolley 179 with 194 Pce. Tool Kit

- Assembled
- In 2 coloured VAROsoft system insert

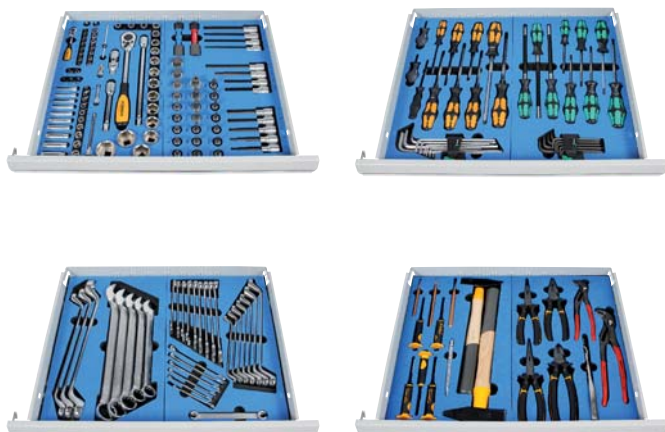

Article No.	Article Description	QTY
4990 179 192	T.T.179BLUE W.T.KIT 194PCE 5*	1
4990 179 192 01	T.T.179BU/A W.T.KIT 194PCE 5*	1
4990 179 192 1	T.T.179 BK W.T.KIT 194PCE 5*	1
4990 179 192 11	T.T.179BK/A./W.T.KIT 194PCE 5*	1
4990 179 192 2	T.T.179 RED W.T.KIT 194PCE 5*	1
4990 179 192 21	T.T.179RD/A. W.T.KIT 194PCE 5*	1

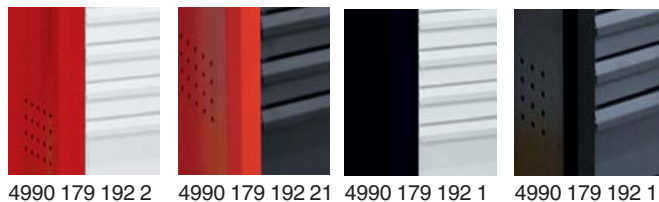

Tool Trolley 861 STRONG with Tool Kit 194 Pce.

- Assembled
- In 2 coloured VAROsoft system inlay

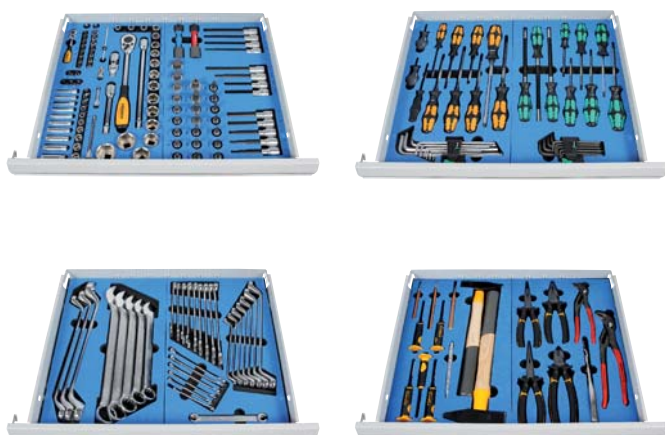

Article No.	Article Description	QTY
4990 861 192	T.TR.861 BL W.T.KIT 194PCE 5*	1
4990 861 192 01	T.TR.861 BL W.T.KIT 194PCE 5*	1
4990 861 192 1	T.TR.861 BK W.T.KIT 194PCE 5*	1
4990 861 192 11	T.TR.861 BK W.T.KIT 194PCE 5*	1
4990 861 192 2	T.TR.861 RED W.T.KIT 194PCE 5*	1
4990 861 192 21	T.TR.861 RED W.T.KIT 194PCE 5*	1

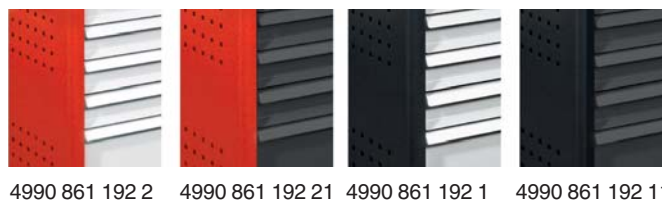

Tool Kit 12-part

- As a possible supplement for tool kit 192 pce.
- In VAROsoft system insert Art. No. 9026 179 1 10 / 9026 861 1 10

Contents:

Article No.	Article Description	Quantity
4628 8	FORKED RING-RATCHET SPANNER 8	1
4628 9	FORKED RING-RATCHET SPANNER 9	1
4628 10	FORKED RING-RATCHET SPANNER 10	1
4628 11	FORKED RING-RATCHET SPANNER 11	1
4628 12	FORKED RING-RATCHET SPANNER 12	1
4628 13	FORKED RING-RATCHET SPANNER 13	1
4628 14	FORKED RING-RATCHET SPANNER 14	1
4628 15	FORKED RING-RATCHET SPANNER 15	1
4628 16	FORKED RING-RATCHET SPANNER 16	1
4628 17	FORKED RING-RATCHET SPANNER 17	1
4628 18	FORKED RING-RATCHET SPANNER 18	1
4628 19	FORKED RING-RATCHET SPANNER 19	1

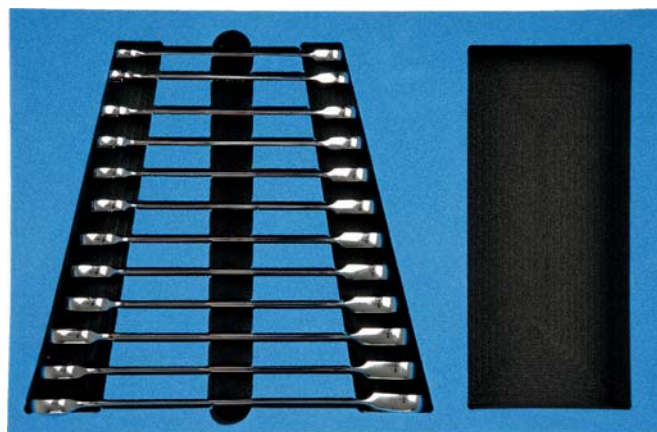

Article No.	Article Description	QTY
4990 179 40 10	TOOL KIT 12-PART	1
4990 861 40 10	TOOL KIT 12-PART FOR 861	1

Tool Kit 3/8“, 48-part

- As a possible supplement for tool kit 192 pce.
- in VAROsoft system insert Art. No. 9026 179 19

Contents:

Article No.	Article Description	Quantity
4401 38 30 50	3/8"REVERSIBLE RATCHET 30T 5*	1
4405 75 50	378" ANGLE EXTENSION 75MM5*	1
4405 125 50	3/8" ANGLE EXTENSION 125MM 5*	1
4405 250 50	3/8" ANGLE EXTENSION 250MM 5*	1
4407 38 50	3/8" ARTICULATION PIECE 5*	1
4424 14 38 50	1/4-3/8"ADAPT.SOCKET WR INS 5*	1
4424 38 12 50	3/8-1/2"ADAPT.SOCKET WR INS 5*	1
4424 38 14 50	3/8-1/4"ADAPT.SOCKET WR INS 5*	1
4426 8 50	3/8"HEX SOCK.INS.SW 8 29MM 5*	1
4426 9 50	3/8"HEX SOCK.INS. SW 9 29MM 5*	1
4426 10 50	3/8"HEX SOCK.INS. SW10 29MM 5*	1
4426 11 50	3/8"HEX SOCK.INS. SW11 29MM 5*	1
4426 12 50	3/8"HEX SOCK.INS.SW12 29MM 5*	1
4426 13 50	3/8"HEX SOCK.INS. SW13 29MM 5*	1
4426 14 50	3/8"HEX SOCK.INS. SW14 29MM 5*	1
4426 15 50	3/8"HEX SOCK.INS. SW15 29MM 5*	1
4426 16 50	3/8"HEX SOCK.INS. SW16 30MM 5*	1
4426 17 50	3/8"HEX SOCK.INS. SW17 30MM 5*	1
4426 18 50	3/8"HEX SOCK.INS. SW18 30MM 5*	1
4426 19 50	3/8"HEX SOCK.INS. SW19 30MM 5*	1
4426 21 50	3/8"HEX SOCK.INS. SW21 30MM 5*	1
4426 22 50	3/8"HEX SOCK.INS. SW22 30MM 5*	1
4426 24 50	3/8"HEX SOCK.INS. SW24 32MM 5*	1
4432 8 1 50	3/8SOCKET-WR 12BIHEXA 8 55MM5*	1
4432 9 1 50	3/8SOCKET-WR 12BIHEXA 9 55MM5*	1
4432 10 1 50	3/8SOCKET-WR 12BIHEXA10 55MM5*	1
4432 11 1 50	3/8SOCKET-WR 12BIHEXA11 55MM5*	1
4432 12 1 50	3/8SOCKET-WR 12BIHEXA12 55MM5*	1
4432 13 1 50	3/8SOCKET-WR 12BIHEXA13 55MM5*	1
4432 14 1 50	3/8SOCKET-WR 12BIHEXA14 55MM5*	1
4432 15 1 50	3/8SOCKET-WR 12BIHEXA15 55MM5*	1
4432 16 1 50	3/8SOCKET-WR 12BIHEXA16 55MM5*	1
4432 17 1 50	3/8SOCKET-WR 12BIHEXA17 55MM5*	1
4432 18 1 50	3/8SOCKET-WR 12BIHEXA18 55MM5*	1
4432 19 1 50	3/8SOCKET-WR 12BIHEXA19 55MM5*	1
4432 20 1 50	3/8SOCKET-WR 12BIHEXA20 55MM5*	1
4432 21 1 50	3/8SOCKET-WR 12BIHEXA21 55MM5*	1
4432 22 1 50	3/8SOCKET-WR 12BIHEXA22 55MM5*	1
4441 4 50	3/8"TX SOCK.WR.INS.E4 26MM 5*	1
4441 5 50	3/8"TX-SOCK.WR.INS.E5 26MM 5*	1
4441 6 50	3/8"TX SOCK.WR.INS.E6 26MM 5*	1
4441 7 50	3/8"TX-SOCK.WR.INS.E7 26MM 5*	1
4441 8 50	3/8"TX-SOCK.WR.INS.E8 26MM 5*	1
4441 10 50	3/8"TX-SOCK.WR.INS.E10 26MM 5*	1
4441 11 50	3/8"TX-SOCK.WR.INS.E11 26MM 5*	1
4441 12 50	3/8"TX-SOCK.WR.INS.E12 26MM 5*	1
4441 14 50	3/8"TX-SOCK.WR.INS.E14 26MM 5*	1
4441 16 50	3/8"TX-SOCK.WR.INS.E16 26MM 5*	1



Article No.	Article Description	QTY
4990 179 40 9	TOOL KIT 3/8" 48-PART 5*	1

Tool Kit 3/8“, 54-pce. FÖRCH*****

Art. No. 4990 179 40 11 / 4990 861 40 11:

- in VAROsoft system tray Art. No. 9026 179 1 11 / 9026 861 1 11
- 54 pieces

Contents:

Article No.	Article Description	Quantity
4401 38 30 50	3/8"REVERSIBLE RATCHET 30T 5*	1
4405 75 50	3/8" ANGLE EXTENSION 75MM5*	1
4405 125 50	3/8" ANGLE EXTENSION 125MM 5*	1
4405 250 50	3/8" ANGLE EXTENSION 250MM 5*	1
4407 38 50	3/8" ARTICULATION PIECE 5*	1
4426 8 50	3/8"HEX SOCK.INS.SW 8 29MM 5*	1
4426 9 50	3/8"HEX SOCK.INS. SW 9 29MM 5*	1
4426 10 50	3/8"HEX SOCK.INS. SW10 29MM 5*	1
4426 11 50	3/8"HEX SOCK.INS. SW11 29MM 5*	1
4426 12 50	3/8"HEX SOCK.INS.SW12 29MM 5*	1
4426 13 50	3/8"HEX SOCK.INS. SW13 29MM 5*	1
4426 14 50	3/8"HEX SOCK.INS. SW14 29MM 5*	1
4426 15 50	3/8"HEX SOCK.INS. SW15 29MM 5*	1
4426 16 50	3/8"HEX SOCK.INS. SW16 30MM 5*	1
4426 17 50	3/8"HEX SOCK.INS. SW17 30MM 5*	1
4426 18 50	3/8"HEX SOCK.INS. SW18 30MM 5*	1
4426 19 50	3/8"HEX SOCK.INS. SW19 30MM 5*	1
4426 21 50	3/8"HEX SOCK.INS. SW21 30MM 5*	1
4426 22 50	3/8"HEX SOCK.INS. SW22 30MM 5*	1
4432 8 1 50	3/8SOCKET-WR 12BIHEXA 8 55MM5*	1
4432 9 1 50	3/8SOCKET-WR 12BIHEXA 9 55MM5*	1
4432 10 1 50	3/8SOCKET-WR 12BIHEXA10 55MM5*	1
4432 11 1 50	3/8SOCKET-WR 12BIHEXA11 55MM5*	1
4432 12 1 50	3/8SOCKET-WR 12BIHEXA12 55MM5*	1
4432 13 1 50	3/8SOCKET-WR 12BIHEXA13 55MM5*	1
4432 14 1 50	3/8SOCKET-WR 12BIHEXA14 55MM5*	1
4432 15 1 50	3/8SOCKET-WR 12BIHEXA15 55MM5*	1
4432 16 1 50	3/8SOCKET-WR 12BIHEXA16 55MM5*	1
4432 17 1 50	3/8SOCKET-WR 12BIHEXA17 55MM5*	1
4432 18 1 50	3/8SOCKET-WR 12BIHEXA18 55MM5*	1
4432 19 1 50	3/8SOCKET-WR 12BIHEXA19 55MM5*	1
4432 20 1 50	3/8SOCKET-WR 12BIHEXA20 55MM5*	1
4432 21 1 50	3/8SOCKET-WR 12BIHEXA21 55MM5*	1
4432 22 1 50	3/8SOCKET-WR 12BIHEXA22 55MM5*	1
4451 3 50	3/8"HEX SCR.DR.AL.KEY 3 38MM5*	1
4451 4 50	3/8"HEX SCR.DR.AL.KEY 4 38MM5*	1
4451 5 50	3/8"HEX SCR.DR.AL.KEY 5 38MM5*	1
4451 6 50	3/8"HEX SCR.DR.AL.KEY 6 38MM5*	1
4451 7 50	3/8"HEX SCR.DR.AL.KEY 7 38MM5*	1
4451 8 50	3/8"HEX SCR.DR.AL.KEY 8 38MM5*	1
4451 9 50	3/8"HEX SCR.DR.AL.KEY 9 38MM5*	1
4451 10 50	3/8"HEX SCR.DR.A.KEY 10 38MM5*	1
4456 10 50	3/8"TX-SCR.DR.INS.10 50MM 5*	1
4456 15 50	3/8"TX-SCR.DR.INS.15 50MM 5*	1
4456 20 50	3/8"TX-SCR.DR.INS.20 50MM 5*	1
4456 25 50	3/8"TX-SCR.DR.INS.25 50MM 5*	1
4456 27 50	3/8"TX-SCR.DR.INS.27 50MM 5*	1
4456 30 50	3/8"TX-SCR.DR.INS.30 50MM 5*	1
4456 40 50	3/8"TX-SCR.DR.INS.40 50MM 5*	1
4456 45 50	3/8"TX-SCR.DR.INS.45 50MM 5*	1
4461 5 50	3/8"XZN-SCR.DR.BIT 550MM 5*	1
4461 6 50	3/8"XZN-SCR.DR.BIT 650MM 5*	1
4461 8 50	3/8"XZN-SCR.DR.BIT 850MM 5*	1
4461 10 50	3/8"XZN-SCR.DR.BIT 1050MM 5*	1



Article No.	Article Description	QTY
4990 179 40 11	TOOL KIT 3/8" 54PIECE 5*	1
4990 861 40 11	TOOL KIT 3/8" 54PIECE F861 5*	1

Tool Kit 223 Pieces **FÖRCH*******



4415 12 21 1 A+ 4430 58 A+ 4584V 5 A+ 5509 5501 9026 70 A+ 4582V 003 A+ 4749V 1 A+ 4715 160 4715 2 9026 70 A+ 4099V 04 5 A+ 4751 1 9026 701 1/2 A+ 4200 10 4201 3 9026 701 1/2 A+ 5422 40 1 4681 220 9026 701 1/2 A+ 5850 5 9026 701 1/2 A+ 4159 20 9026 701 1/2 A+



4209V 1 A 4415 14 33 A 4584V 013 A 4582V 007 A 4652V 02 A 4580V 010 2x A 4708V 091 B 4923 20 9026 90 D



4701 26
4703 6

Distribution of VAROsoft system inserts:

- 8x VS-system insert A+, (W x D): 144 x 405 mm
- 5x VS-system insert 1/2 A+, (W x D): 72 x 405 mm
- 5x VS-system insert A, (W x D): 144 x 328 mm
- 1x VS-system insert B, (W x D): 144 x 164 mm
- 7x VS-system insert D, (W x D): 144 x 77 mm

Art. No. 4415 14 33:

- 33-part in VAROsoft system insert Art. No. 9026 632
- Art. No. 4401 14 20 50: 1/4 „ lever switch ratchet 20 teeth FÖRCH 5*
- Art. No. 4418 75 50: 1/4" square extension FÖRCH 5*, 75 mm
- Art. No. 4418 150 50: 1/4" square extension FÖRCH 5*, 150 mm
- Art. No. 4407 14 50: 1/4" articulation piece FÖRCH 5*, 35 mm
- AGR 4471...50: 1/4" LS socket wrench insert FÖRCH 5* 3.5 / 5.5
- AGR 4470...50: 1/4" PH-socket wrench insert FÖRCH 5* 1 / 2
- AGR 4455...50: 1/4" TX-socket wrench inserts FÖRCH 5* 8 / 9 / 10 / 15 / 20 / 25 / 27 / 30 / 40
- AGR 4450...50: 1/4" hexagon socket wrench inserts FÖRCH 5* 3 / 4 / 5 / 6 / 8
- AGR 4425...50: 1/4" hexagon socket wrench inserts FÖRCH 5*, 23 mm SW 4 / 5 / 5.5 / 6 / 7 / 8 / 9 / 10 / 11 / 12 / 13

Art. No. 4415 12 21 1:

- 21-part in VAROsoft system insert Art. No. 9026 729
- Art. No. 4401 12 32 50: 1/2" lever switch ratchet 32 teeth FÖRCH 5*
- Art. No. 4407 12 50: 1/2" articulation piece FÖRCH 5*, 69 mm
- Art. No. 4420 125 50: 1/2" square extension FÖRCH 5*, 125 mm
- Art. No. 4420 250 50: 1/2" square extension FÖRCH 5*, 250 mm
- AGR 4427... 50: 1/2" hexagon socket wrench inserts FÖRCH 5*, 37 mm SW 10 / 11 / 12 / 13 / 14 / 15 / 16 / 17 / 18 / 19 / 20 / 21 / 22 / 24 / 27 / 30 / 32

Art. No. 4430 58:

- 57-part in VAROsoft system insert Art. No. 9026 76
- AGR 4440: Insert 1/4"-drive TX E4, E5, E6, E7, E8
- AGR 4442: Insert 1/2"-drive TX E10, E11, E12, E14, E16, E18, E20
- AGR 4320: Special-Bit TX-long TX 20 / 25 / 27 / 30 / 40 / 45 / 50 / 55 / 60

- AGR 4320: Special-Bit TX-short with face spanner drilling TX 20 / 25 / 27 / 30 / 40 / 45 / 50 / 55 / 60
- AGR 4322: Internal serration bit-long XZN 6 / 8 / 10 / 12
- AGR 4322: Internal serration bit-short XZN 5 / 6 / 8 / 10 / 12
- AGR 4323: Hexagon bit-long SW 5 / 6 / 7 / 8 / 10
- AGR 4323: Hexagon bit-short SW 4 / 5 / 6 / 7 / 8 / 10 / 12
- AGR 4324: Slotted bit short LS 8 / 10
- AGR 4325: Philips-bit short PH 2 / 3
- Art. No. 4361 12 10: Bit-Adapter 1/2"
- Art. No. 4401 10: 10 mm bit-ratchet length 112 mm

Art. No. 4159 20:

- Hex-Plus-Allen key set 9 pieces
- With ball head SW 1.5 / 2 / 2.5 / 3 / 4 / 5 / 6 / 8 / 10

Art. No. 4751 1:

- Sealant scraper 260 x 150 x 23

Art. No. 4652V 02:

- 2 pieces in VAROsoft system insert Art. No. 9026 620
- 4650 180: Knipex Water pump pliers 180 mm 5*
- 4650 300: Knipex Water pump pliers 300 mm 5*

Art. No. 4099V 04 5:

- 4 pieces in VAROsoft system insert Art. No. 9026 724 1
- 4000 180 5: Combi pliers 180 mm FÖRCH 5*
- 4010 180 5: Side cutter 180 mm FÖRCH 5*
- 4030 205 5: Flat-nose pliers straight 205 mm FÖRCH 5*
- 4040 205 5: Flat-nose pliers angled 205 mm FÖRCH 5*

Art. No. 4749V 1:

- 5 pieces in VAROsoft system insert Art. No. 9026 721
- Each 1 flat, round, half-round, three-square and square stroke 2 file

Art. No. 4582V 007:

- 7 pieces in VAROsoft system insert Art. No. 9026 69
- AGR 4582: Double ring spanner cranked SW 6 x 7 / 8 x 9 / 10 x 11

Tool Kit 223 Pieces **FÖRCH*******

/ 12 x 13 / 14 x 15 / 16 x 17 / 18 x 19

Art. No. 5509 5501:

- 19-part in plastic cassette
- Twist drill DIN 338 ground Ø 1.0 – 10 (increments of 0.5 mm)

Art. No. 4200 10:

- M4 screwdriver DG KL 20

Art. No. 4201 3:

- M4 screwdriver DG KL PH3

Art. No. 4209V 1:

- 6 pieces in VAROsoft system insert Art. No. 9026 62
- AGR 4200: MK screwdriver DG. KL. LS 3.5 / 4.5 / 5.5 / 7
- AGR 4205: MK screwdriver DG. KL. PH 1 / 2

Art. No. 4681 220:

- Rabitz pliers DIN 9242, 220 mm

Art. No. 4923 20:

- Feeler gauge 0.05 – 1.00 mm, 20 blades

Art. No. 4582V 003:

- 3 pieces in VAROsoft system insert Art. No. 9026 717
- AGR 4582: Double ring spanner cranked SW 20 x 22 / 24 x 27 / 30 x 32

Art. No. 4584V 013:

- 13 pieces in VAROsoft system insert Art. No. 9026 631
- AGR 4584: Combination wrench angled SW 8 / 9 / 10 / 11 / 12 / 13 / 14 / 15 / 16 / 17 / 18 / 19 / 21

Art. No. 4584V 5:

- 5 pieces in VAROsoft system insert Art. No. 9026 720
- AGR 4584: Combination wrench angled SW 22 / 24 / 27 / 30 / 32

Art. No. 4701 26:

- Flat chisel DIN 6453 26 x 250 mm

Art. No. 4703 6:

- Wedge chisel DIN 6451 6 x 150 mm

Art. No. 5850 5:

- Hand wire brush steel 5-row

Art. No. 5422 40 1:

- Spatula 40 mm

Art. No. 4715 160:

- In plastic etui caliper 150 mm

Art. No. 4715 2:

- Pocket rule 2 m

Art. No. 4580V 010:

- 10-part in VAROsoft system insert Art. No. 9026 111
- AGR 4580: Double fork spanner SW 6 x 7 / 8 x 9 / 10 x 11 / 12 x 13 / 14 x 15 / 16 x 17 / 18 x 19 / 20 x 22 / 24 x 27 / 30 x 32

Art. No. 4708 092:

- 5-piece AGR 4708: Pin punch XXL Ø 8 / 9 / 10 / 12 / 14 / 16

Art. No. 4708V 091:

- 5-part in VAROsoft system insert Art. No. 9026 818
- AGR 4708: Pin punch FÖRCH 5* Ø 3 / 4 / 5 / 6 / 8 mm

Art. No. 4720 5 400:

- Engineer's hammer in compliance with DIN 400 g 5*

Art. No. 4720 5 800:

- Engineer's hammer in compliance with DIN 800 g 5*

Art. No. 4726 40:

- Soft face hammer recoil-free Ø 40 mm

Art. No. 4990 179 314:

- Shelf divider set for workshop trolley 179

Art. No. 9026 701:

- 5x VAROsoft system insert empty 1/2 A+

Art. No. 9026 70:

- 2x VAROsoft system insert empty A+

Art. No. 9026 90:

- 7x VAROsoft system insert empty D

Article No.	Article Description	QTY
4990 223	TOOL KIT 223-PIECE 5*	1

Tool Trolley Mechanic with 223-pcs. Tool Kit **FÖRCH*******

- Assembled
- Application example of VAROsoft-System tray in the drawer of tool trolley mechanic 179

VAROsoft 1/2 A+	VAROsoft A+	VAROsoft D	VAROsoft D
		VAROsoft A	VAROsoft B
			VAROsoft C



4990 179 205



4990 179 205 01

Article No.	Article Description	QTY
4990 179 205	T.T.179BLUE W.T-KIT 223PCS 5*	1
4990 179 205 1	T.T.179 RED W.T-KIT 223PCS 5*	1
4990 179 205 2	T.T.179BLACK W.T-KIT 223PCS 5*	1
4990 179 205 01	T.T.179 BL/ANT.W.T.K.223PCE 5*	1
4990 179 205 11	T.T.179 RD/ANT.W.T.K.223PCE 5*	1
4990 179 205 21	T.T.179 BK/ANT.W.T.K.223PCE 5*	1



4990 179 205 1 4990 179 205 11 4990 179 205 2 4990 179 205 21

Tool Kit 238 Pcs.



4415 12 25 A+ 4430 58 A+ 4584V 5 A+ 5509 5501 9026 70 A+ 4582V 003 A+ 4749V 1 A+ 4715 160 4715 2 9026 70 A+ 4099V 04 A+ 4751 1 4751 10 9026 701 1/2 A+ 4200 10 4201 3 9026 701 1/2 A+ 5422 40 1 4681 220 9026 701 1/2 A+ 5850 5 9026 701 1/2 A+ 4159 20 9026 701 1/2 A+



4209V 1 A 4415 14 47 A 4584V 013 A 4582V 007 A 4652V 02 A 4580V 010 2x A 4708V 091 B 4923 20 9026 90 D 4708 092 4720 5 800 4701 26 4703 6 4726 40 4720 5 400

Distribution of VAROsoft system insert:

- 8x VS-system insert A+, (W x D): 144 x 405 mm
- 5x VS-system insert 1/2 A+, (W x D): 72 x 405 mm
- 5x VS-system insert A, (W x D): 144 x 328 mm
- 1x VS-system insert B, (W x D): 144 x 164 mm
- 7x VS-system insert D, (W x D): 144 x 77 mm

Art. No. 4415 14 47:

- 47 pieces in VAROsoft system insert Art. No. 9026 63
- Art. No. 4401 14 36: Reversible ratchet 1/4"
- Art. No. 4403 141: Twist handle
- Art. No. 4402 14: T-handle
- Art. No. 4407 14: Articulation piece
- Art. No. 4418 50: Square extension 50 mm
- Art. No. 4418 125: Square extension 125 mm
- Art. No. 4417 14 150: Square extension flexible 150 mm
- Art. No. 4361 14 64: Plug adapter 1/4" hexagonal x 1/4" square
- AGR 4425: Socket wrench inserts short 25 mm SW 4 / 5 / 5.5 / 6 / 7 / 8 / 9 / 10 / 11 / 12 / 13
- AGR 4425: Socket wrench inserts long 50 mm SW 6 / 7 / 8 / 10 / 11 / 12 / 13
- AGR 4450: Hex bit socket wrench SW 3 / 4 / 5 / 6 / 7 / 8
- AGR 4470: Cross recessed bit socket wrench insert PH 1 / 2 / 3
- AGR 4471: Bit slotted socket wrench insert 4 / 5
- AGR 4455: Bit TX socket wrench insert with drilled head TX 10 / 15 / 20 / 25 / 27 / 30 / 40
- AGR 4462: Bit socket wrench insert - multiple teeth M5 / M6 / M8

Art. No. 4415 12 25:

- 25 pieces in VAROsoft system insert Art. No. 9026 71
- Art. No. 4401 12 36: Reversible ratchet 1/2"
- Art. No. 4420 125: Square extension 125 mm
- Art. No. 4420 250: Square extension 250 mm
- Art. No. 4407 12: Articulation piece
- Art. No. 4402 12: T-handle
- AGR 4427: Hex socket wrench inserts SW 8 / 9 / 10 / 11 / 12 / 13 / 14 / 15 / 16 / 17 / 18 / 19 / 20 / 21 / 22 / 24 / 27 / 30 / 32 / 34

Art. No. 4430 58:

- 57-part in VAROsoft system insert Art. No. 9026 76
- AGR 4440: Insert 1/4"-drive TX E4, E5, E6, E7, E8
- AGR 4442: Insert 1/2"-drive TX E10, E11, E12, E14, E16, E18, E20
- AGR 4320: Special bit TX-long TX 20 / 25 / 27 / 30 / 40 / 45 / 50 / 55 / 60
- AGR 4320: Special bit TX-short with face drilling TX 20 / 25 / 27 / 30 / 40 / 45 / 50 / 55 / 60
- AGR 4322: Internal serration bit long XZN 6 / 8 / 10 / 12
- AGR 4322: Internal serration bit short XZN 5 / 6 / 8 / 10 / 12
- AGR 4323: Hex socket bit long SW 5 / 6 / 7 / 8 / 10
- AGR 4323: Hex socket bit short SW 4 / 5 / 6 / 7 / 8 / 10 / 12
- AGR 4324: Slotted bit short LS 8 / 10
- AGR 4325: Philips bit short PH 2 / 3
- Art. No. 4361 12 10: Bit adapter 1/2"
- Art. No. 4401 10: 10 mm bit ratchet, length 112 mm

Art. No. 4159 20:

- Hex-Plus-Allen wrench set
- 9-piece
- With ball head SW 1.5 / 2 / 2.5 / 3 / 4 / 5 / 6 / 8 / 10

Art. No. 4751 1:

- Sealant scraper 260 x 150 x 23

Art. No. 4751 1 0:

- Sealant scraper Mini 140 x 80 x 23

Art. No. 4652V 02:

- 2-part in VAROsoft system insert Art. No. 9026 620
- Art. No. 4650 180: Knipex waterpump pliers 180 mm FÖRCH 5*
- Art. No. 4650 300: Knipex waterpump pliers 300 mm FÖRCH 5*

Art. No. 4099V 04:

- 4-part in VAROsoft system insert, Art. No. 9026 721
- Art. No. 4000 180: Combination pliers 180 mm
- Art. No. 4010 180: Side cutter 180 mm
- Art. No. 4030 200: Flat-nosed pliers straight 200 mm
- Art. No. 4040 200: Flat-nosed pliers angled 200 mm

(Continued on next page)

Tool Kit 238 Pcs.

Art. No. 4749V 1:

- 5-part in VAROsoft system insert Art. No. 9026 721
- 1 file flat, round, half-round, triangle and square stroke 2

Art. No. 4582V 007:

- 7-part in VAROsoft system insert Art. No. 9026 69
- AGR 4582: Offset double-end ring spanner SW 6 x 7 / 8 x 9 / 10 x 11 / 12 x 13 / 14 x 15 / 16 x 17 / 18x 19

Art. No. 5509 5501:

- 19-part in plastic cassette
- Twist drills DIN 338 ground Ø 1.0 - 10 (increments of 0.5 mm)

Art. -o. 4200 10:

- M4 screwdriver DG KL 10

Art. No. 4201 3:

- M4 screwdriver DG KL PH3

Art. No. 4209V 1:

- 6-part in VAROsoft system insert Art. No. 9026 62
- AGR 4200: MK screwdriver DG. KL. LS 3.5 / 4.5 / 5.5 / 7
- AGR 4205: MK screwdriver DG. KL. PH 1 / 2

Art. No. 4681 220:

- Rabbit pliers DIN 9242, 220 mm

Art. No. 4923 20:

- Feeler gauge 0.05 – 1.00 mm 20 sheets

Art. No. 4582V 003:

- 3-part in VAROsoft system insert Art. No. 9026 717
- AGR 4582: Offset double-end ring spanner SW 20 x 22 / 24 x 27 / 30 x 32

Art. No. 4584V 013:

- 13-part in VAROsoft system insert Art. No. 9026 631
- AGR 4584 Angled combination wrench SW 8 / 9 / 10 / 11 / 12 / 13 / 14 / 15 / 16 / 17 / 18 / 19 / 21

Art. No. 4584V 5:

- 5-part in VAROsoft system insert Art. No.9026 720
- AGR 4584: Angled combination wrench SW 22 / 24 / 27 / 30 / 32

Art. No. 4701 26:

- Flat chisel DIN 6453 26x250 mm

Art. No. 4703 6:

- Cross chisel DIN 6451 6x150 mm

Art. No. 5850 5:

- Hand wire brush, steel, 5-row

Art. No. 5422 40 1:

- Spatula 40 mm

Art. No. 4715 160:

- In plastic bag - caliper rule 150 mm

Art. No. 4715 2:

- Pocket rule 2 m

Art. No. 4580V 010:

- 10-part in VAROsoft tool deposit Art. No. 9026 111
- AGR 4580: Double-end spanner SW 6 x 7 / 8 x 9 / 10 x 11 / 12 x 13 / 14 x 15 / 16 x 17 / 18 x 19 / 20 x 22 / 24 x 27 / 30 x 32

Art. No. 4708 092:

- 5-part AGR 4708 Pin punch XXL Ø 8 / 9 / 10 / 12 / 14 / 16

Art. No. 4708V 091:

- 5-part in VAROsoft system insert Art. No. 9026 818
- AGR 4708: Pin punch FÖRCH 5* Ø 3 / 4 / 5 / 6 / 8 mm

Art. No. 4720 5 400:

- Engineer's hammer according to DIN 400 g FÖRCH 5*

Art. No. 4720 5 800:

- Engineer' hammer according to DIN 800 g FÖRCH 5*

Art. No. 4726 40:

- Soft face hammer recoil-free Ø 40 mm

Art. No. 4990 179 314:

- Divider set for workshop trolley 179

Art. No. 9026 701:

- 5x VAROsoft system insert empty 1/2 A+

Art. No. 9026 70:

- 2x VAROsoft system insert empty A+

Art. No. 9026 90:

- 7x VAROsoft system insert empty D

Article No.	Article Description	QTY
4990 237	TOOL KIT SET 238 PIECES	1

Tool Trolley Mechanic with 238 Pcs. Tool Kit

- Assembled
- Application example of VAROsoft-System tray in the drawer of tool trolley mechanic 179

VAROsoft 1/2 A+	VAROsoft A+	VAROsoft D	VAROsoft D
		VAROsoft A	VAROsoft B
			VAROsoft C



4990 179 200



4990 179 200 01

Article No.	Article Description	QTY
4990 179 200	T.TROLLEY179BLUE W.T-KIT238PCS	1
4990 179 200 1	T.TROLLEY179 RED W.T-KIT238PCS	1
4990 179 200 2	T.TROL.179 BLACK.W.T-KIT238PCS	1
4990 179 200 01	T.TROL.179BL/ANT W.T-KIT238PCS	1
4990 179 200 11	TROLLEY 179 RED/ANT W.T-KIT238	1
4990 179 200 21	T.TROL.179BL/ANT.W.T-KIT238PCS	1



4990 179 200 1 4990 179 200 11 4990 179 200 2 4990 179 200 21

VAROsoft System Inserts, Non-Equipped

- FÖRCH ordering concept for more productivity and overview and highest flexibility at the same time

Dimensions:

Art. No. 9026 70:

- H x W x D: 40 x 144 x 405 mm

Art. No. 9026 70 1:

- H x W x D: 40 x 72 x 405 mm

Art. No. 9026 70 2:

- H x W x D: 40 x 89 x 405 mm

- for tool trolley 179 TXXL

Art. No. 9026 70 3:

- H x W x D: 40 x 120 x 405 mm

- for tool trolley 179 XL

- for tool trolley mechanics

Art. No. 9026 60:

- H x W x D: 33 x 144 x 328 mm

Art. No. 9026 80:

- H x W x D: 33 x 144 x 164 mm

Art. No. 9026 101:

- H x W x D: 33 x 72 x 164 mm

Art. No. 9026 90:

- H x W x D: 33 x 144 x 77 mm

Art. No. 9026 200:

- H x W x D: 33 x 576 x 77 mm

VARO sizes for drawers of workshop trolley:

Art. No. 4990 660:

- W x D: 432 x 328 mm

Art. No. 4990 179:

- W x D: 504 x 405 mm

Art. No. 4990 860:

- W x D: 576 x 405 mm

Art. No. 4990 173:

- W x D: 620 x 405 mm

Art. No. 4990 179 5:

- W x D: 694 x 405 mm

Art. No. 4990 179 6:

- W x D: 864 x 405 mm

Art. No. 4990 820:

- W x D: 708 x 405 mm



9026 70



9026 70 1



9026 70 2



9026 70 3

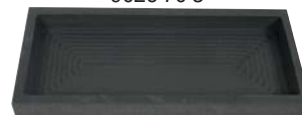

9026 60



9026 80



9026 101



9026 90



9026 200

Article No.	Article Description	QTY
9026 70	TOOL TRAY VS EMPTY A+	1
9026 70 1	TOOL TRAY VS EMPTY 1/2 A+	1
9026 70 2	TOOL TRAY EMPTY B 90MM A+	1
9026 70 3	TOOL TRAY EMPTY B120MM A+	1
9026 60	TOOL TRAY VS EMPTY A	1

Article No.	Article Description	QTY
9026 80	TOOL TRAY VS EMPTY B	1
9026 101	TOOL TRAY VS EMPTY LONGITUD. C	1
9026 90	TOOL TRAY VS EMPTY CROSSWAYS D	1
9026 200	TOOL TRAY VS EMPTY 4XD	1

Drawer Trays for Tool Trolley

- Material strength: 6 mm
- Material: cell rubber
- Prevents slipping of tools

Dimensions:

Art. No. 9026 660 0:

- H x W x D: 6 x 440 x 350 mm

Art. No. 9026 660 1:

- H x W x D: 30 x 16 x 770 mm

- To fill out the gap of the drawer of tool trolley 660

Art. No. 9026 860 0:

- H x W x D: 6 x 575 410 mm

Art. No. 9026 179 0:

- H x W x D: 6 x 524 x 405 mm

Article No.	Article Description	QTY
9026 660 0	DRAWER TRAY F.TOOL TROLLEY 660	1
9026 660 1	DRAWER TRAY 660 770X30X16MM	1
9026 860 0	DRAWER TRAY F.TOOL TROLLEY 860	1
9026 179 0	DRAWER TRAY F.TOOL TROLLEY 179	1



VAROsoft System Inserts, Non-Equipped

Tool Trolley 661

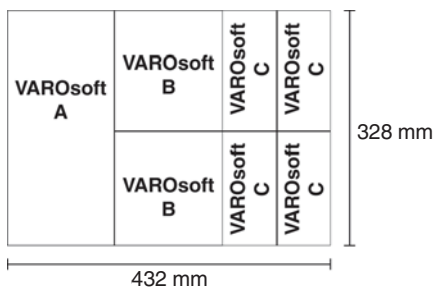

Werkzeugwagen Mechanics

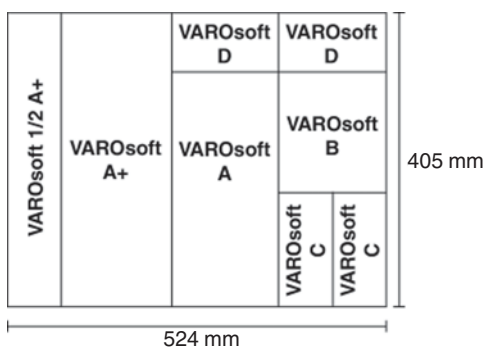

Tool Trolley 861

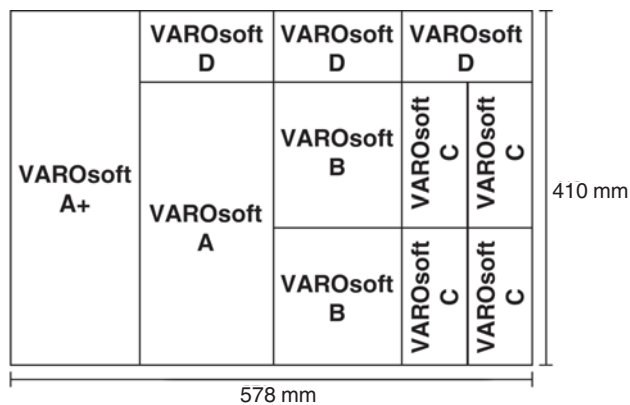

Tool Trolley 865 **ECO**

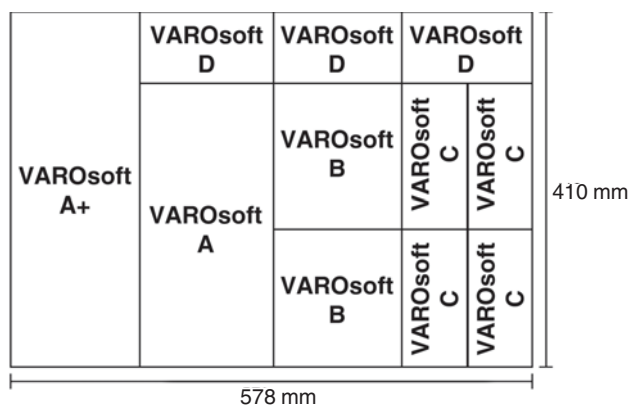

Tool Trolley Mechanics XXL

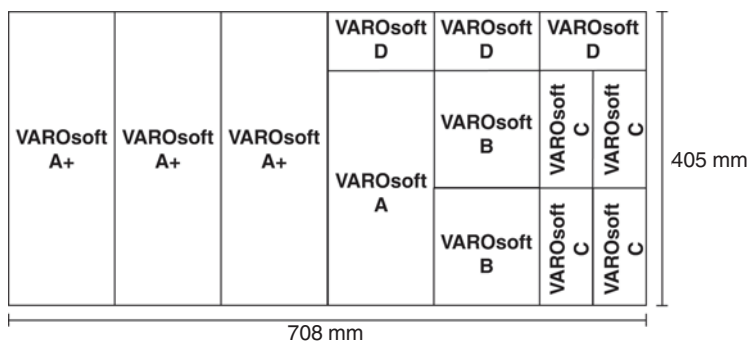

VAROsoft System Inserts, Non-Equipped

Tool Trolley Mechanics XL

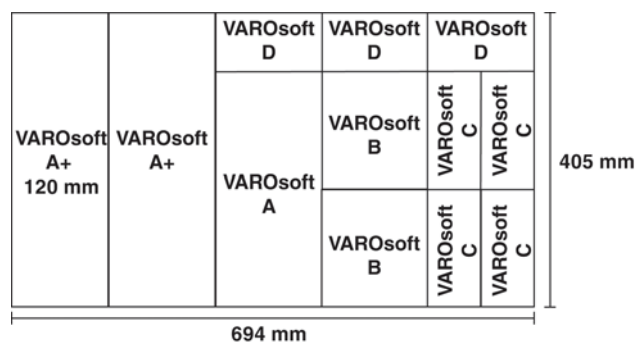

Tool Trolley 179 XL

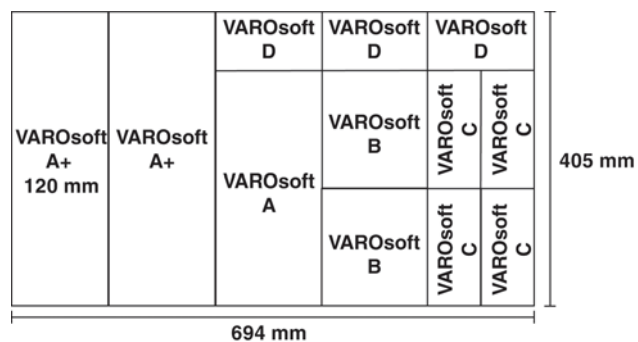

Tool Trolley 179 XXL

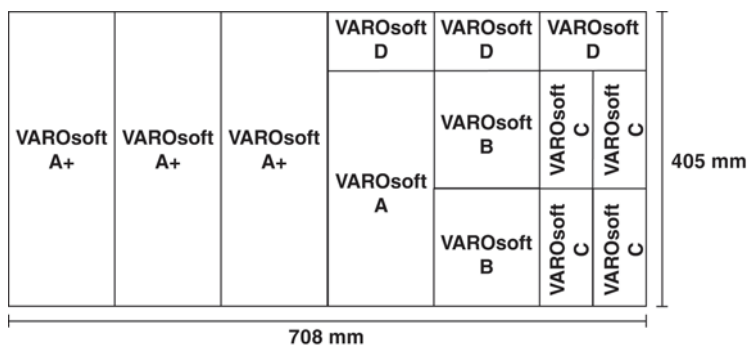

Can Holder

- Can be mounted onto the tool trolley
- 8-fold
- Dimensions L x W x H: 345 x 145 x 245 mm
- RAL 5003 blue
- Suitable for PFA-service trolley pro Art. No. 4990 790
- Suitable for tool trolley Art. No. 4990 660

Article No.	Article Description	QTY
4990 8	CAN HOLDER 8-FOLD EMPTY	1

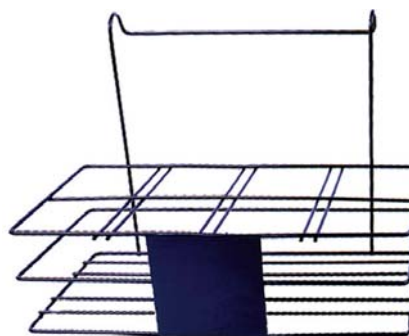

Chemical Storage for Cans

- Perfect addition to tool trolley or hole wall
- Excellent storage options for numerous aerosol cans and litre cans
- Secure storage due to high side walls
- RAL 5003 blue, RAL 7016 anthracite, RAL 7035 light grey
- Dimensions (L x W x H): 300 x 90 x 120 mm
- Suitable for tool trolleys Art. No. 4990 179, Art. No. 4990 660, Art. No. 4990 820, Art. No. 4990 860 / 861



4990 695



4990 695 1



4990 699 1

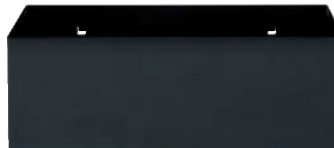

4990 695 01



4990 695 02

Article No.	Article Description	QTY
4990 695	CHEM.STORAGE F.CANS W/O MAGN.	1
4990 695 01	CHE.STORAGE F.CANS ANTHRACITE	1
4990 695 02	CHE.STORAGE F.CANS LIGHT GREY	1
4990 695 1	CHEM.STORAGE F.CANS WITH MAGN.	1
4990 699 1	POWER MAGNET M6 DXH 66X8.5MM	1

Chemical Can 8-fold

- Perfect compliment to tool trolleys with wall hole
- To hold aerosol cans and chemical products
- With sturdy dividers
- RAL 5003 blue
- Dimensions (L x W x H): 300 x 160 x 120 mm
- Suitable for tool trolleys Art. No. 4990 179, Art. No. 4990 660, Art. No. 4990 860 / 861, Art. No. 4990 820
- Suitable for PFA service trolley pro Art. No. 4990 790

Article No.	Article Description	QTY
4990 695 8	CHEMICAL STORAGE 8-FOLD	1



Storage Compartment for Tool Trolley

- Useful storage for small items, aerosol cans and tools
- RAL 7016 anthracite grey

Art. No. 4990 691:

- Dimensions (L x W x H): 215 x 80 x 60 mm

Art. No. 4990 692:

- Dimensions (L x W x H): 215 x 180 x 60 mm
- Suitable for tool trolleys 4990 179, Art. No. 4990 660, Art. No. 4990 820, Art. No. 4990 860 / 861



4990 691



4990 692

Article No.	Article Description	QTY
4990 691	PACKAGE TRAY LXWXH 215X80X60MM	1
4990 692	PACKAGE TRAY LXWXH215X180X60MM	1

Chemical Box XXL

- Perfect addition for tool trolley PFA / painter (Art. No. 4990 740)
- To hold aerosols and chemical products
- Sturdy dividers consisting of 2 slotted walls for longitudinal division and 8 partition plates for transversal division
- With 2 carrying handles
- RAL 5003 blue
- Dimensions (L x W x H): 100 x 400 x 295 mm

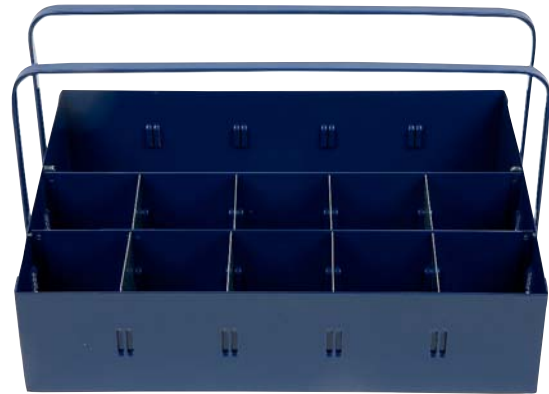

Article No.	Article Description	QTY
4990 791	CHEMICAL BOX XXL	1

Holder for Sealing Compound/Adhesive 4-fold

- Ideal for the storage of adhesive and sealant containers with **turnable dosing cap system**
- RAL 5003 blue
- Dimensions LxWxH: 230 x 60 x 60 mm
- Hole diameter: 1 x 47 mm, 2 x 40 mm, 1 x 35 mm
- Matching the VARO hole wall
- Matching the tool trolley Art. No. 4990 179, Art. No. 4990 660, Art. No. 4990 820, Art. No. 4990 860 / 861

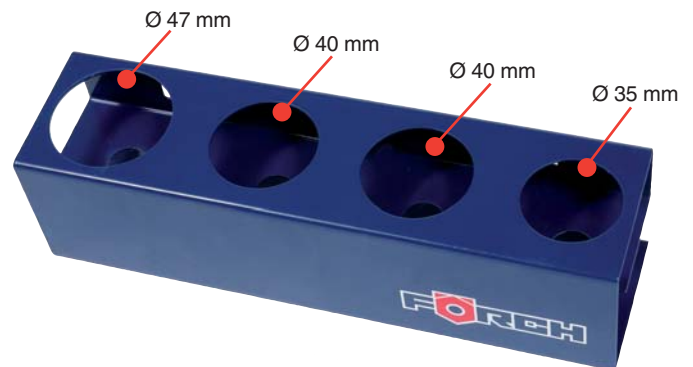

FÖRCH 5-Star Seal- and adhesive compound diameter:

Article-No.	Article Description	d=max
6410 4107	SUPERGLUE K186 5* BO. 5G	35 mm
6410 4108	SUPERGLUE K186 5* BO. 30G	35 mm
6410 4131	SUPERGLUE-CYBERSP.ADH.K187 20G	35 mm
6410 4137	SUPERGLUE BLACK K188 5* 20G	35 mm
6410 4139	SUPERGLUE HIGH VISCOS.K189 30G	35 mm
6420 4000	SCREW LOCK MED. K175 50G 5*	40 mm

6420 4005	SCREW LOCK.HIGH-TENS. K176 50G	40 mm
6420 4018	FL(50G)ASS. SEALING HF K182 5*	40 mm
6480 4519	ENGINE SEAL. GASKET K157 100G	40 mm
6420 4010	TB(50G)PI.THRE.SEAL.MF K177 5*	47 mm
6420 4012	TB(50G)PI.THRE.SEAL.NF K178 5*	47 mm
6480 4520	ORANGE SEAL. COMPOUND MED. 50G	47 mm

Article No.	Article Description	QTY
4990 696	HOLDER FOR SEALING COMPOUND/AD	1

Tool Trolley Attachment Table Foldable

- Additional work space for attaching to the tool trolley in 2 sizes
- Quick and easy installation
- Space-saving: foldable when not in use
- The narrow mounting table for tool trolley Art. No. 4990 861 folds flush when mounted to the rear wall
- Maximum load 30 kg

Work surface extension table for Tool Trolley 660 / 661:

- Narrow extension table: 46 cm x 38 cm
- Broad extendable table: 66 cm x 38 cm

Work surface extension table for Tool Trolley 860 / 861:

- Narrow extension table: 37 cm x 38 cm
- Broad extendable table: 57 cm x 38 cm

Work surface extension table for Tool Trolley 179:

- Narrow extension table: 31 cm x 35 cm
- Broad extendable table: 57 cm x 35 cm

Colour extension tables narrow / wide for Tool Trolley 860 / 861, 179:

- Blue (RAL 5003), red (RAL 2002), black (RAL 9005)

Colour extension tables narrow / wide for Tool Trolley 660 / 661:

- Blue (RAL 5003), red (RAL 2002)



4990 660 44
4990 861 44
4990 179 44



4990 660 43
4990 861 43
4990 179 43



4990 660 44 1
4990 861 44 1
4990 179 44 2



4990 179 43 2



4990 861 44 2

Article No.	Article Description	QTY
4990 660 43	EXT.TABLE BLUE 660/661 SLIM	1
4990 660 44 1	EXT.TABLE RED 660/661 LARGE	1
4990 861 43	EXT.TABLE BLUE 860/861 SLIM	1
4990 861 44	EXT.TABLE BLUE 860/861 LARGE	1
4990 861 44 1	EXT.TABLE RED 860/861 LARGE	1
4990 179 43	EXT.TABLE BLUE 179 SLIM	1
4990 179 44	EXT.TABLE BLUE 179 LARGE	1
4990 179 44 2	EXT.TABLE RED 179 LARGE	1



Rolling Workbench Pro and Upper Part

Equipment of rolling workbench:

- Dimension (H x W x D): 925 x 1200 x 600 mm
- 1 drawer over the total width, load 60 kg, (L x D x H): 999 x 539 x 135 mm
- 2 drawers right, load 35 kg, (L x D x H): 459 x 539 x 90 mm
- 1 drawer right, load 35 kg, (L x D x H): 459 x 539 x 135 mm
- 1 drawer right, load 35 kg, (L x D x H): 459 x 539 x 180 mm
- Ball bearing, 80% telescopic
- 1 cabinet with door and tray divider left, (L x D x H): 486 x 570 x 506 mm
- Central and single locking of the drawers and doors
- Counter top Multiplex 1,200 x 600 x 25 mm
- Steel handle for the movement of the rolling workbench, left and right mountable
- 4 big wheels Ø 125 mm, load per wheel 150 kg 2x braked
- Total load capacity statical 600 kg

Equipment of upper part:

- Dimension (H x W x D): 600 x 1,200 x 300 mm
- 2 doors together with cylinder lock lockable
- Partition wall in the middle, right and left each with 1 tray divider
- Upper part completely welded
- Prepared for re-fitting of the rolling workbench or usable as wall closet
- Weight 35 kg

Art. No. 4990 855

- **Tray divider set H = 50 mm**
- For drawers with orifice height 90 mm
- Arrangement 1/3
- Contents: 2 slotted walls, 9 separating plates

Art. No. 4990 856

- **Tray divider set H = 100 mm**
- For drawers with orifice height 135/180 mm
- Arrangement 1/3
- Contents: 2 slotted walls, 9 separating plates

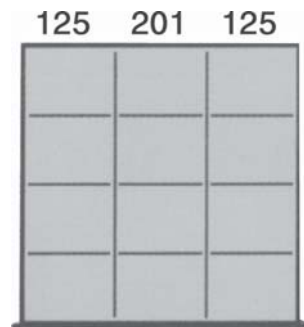

Compartment Separator Set

Article No.	Article Description	QTY
4990 850	FÖRCH ROLLING WORKBENCH PROFI	1
4990 851	UPPER PART F.ROLLING WORKBENCH	1
4990 855	TRAY DIVIDER SET H=50MM F.850	1
4990 856	TRAY DIVIDER SET H=100MM F.850	1

Workbench

Equipment of workbench:

- Dimensions (L x D x H): 1,200 x 600 x 850 mm
- 1 drawer, variable adjustable, (L x D x H): 440 x 540 x 160 mm
- 2 drawers, variable adjustable, (L x D x H): 440 x 540 x 70 mm
- Ball bearing, 80 % extractable
- total load: 500 kg
- load per drawer 30 kg
- Steel sheet cabinet with lockable door, L x D x H: 460x570x420 mm and 2 intermediate bases
- Workbench plate (furniture chipboard) top and bottom side provided with beech wood plate, L x D x H: 1,200 x 600 x35 mm

Frame:

- Feet square pipe 40 x 40 x 2 mm
- Longitudinal bracing square pipe 30 x 30 x 2 mm
- Angle frame sheet 3 mm
- Plastic glider at the feet
- Colour: corpus blue, drawer/door light grey



Article No.	Article Description	QTY
5437 1200	WORKBENCH 1200MM	1

Workbench 1501

- Counter top made of multilayered glued beech wood, 40 mm
- Base frame made of steel sections with panel for bottom attachment
- Drawer made quality sheet steel, ball bearing guiding rails
- Lockable drawer, loadable with overer 40 kg (H x W x D: 150 x 430 x 540 mm)
- Dimension: H x W x D: 840 x 1,500 x 700 mm
- Colour: blue

Article No.	Article Description	QTY
5437 150 1	WORKBENCH 1500MM WITH DRAWER	1



Workbench 1502

- Counter top made of multilayered glued beech wood, 40 mm
- Base frame made of u-section with panel for bottom attachment
- Substruction cabinet with ball bearing drawer, lockable
- Cabinet with 2 lower shelves (H x W x D: 670 x 510 x 630 mm)
- Dimension: H x W x D: 840 x 1,500 x 700 mm
- Colour: blue

Article No.	Article Description	QTY
5437 150 2	WORKBENCH 1500MM W.HANG.LOCKER	1



Workbench 2001

- Counter top made of multilayered glued beech wood, 40 mm
- Base frame made of u-section with panel for bottom attachment
- Substruction cabinet with folding door and 2 lower shelves, lockable
- Dimension H x W x D: 840 x 2,000 x 700 mm
- Colour: blue

Article No.	Article Description	QTY
5437 200 1	WORKBENCH 2000MM WITH LOCKER	1



Vices

- Completely made of steel
- Forged in die
- With break resistance guarantee
- Heavy duty functional components like clamping jaws, anvils and guiding rails are additionally surface hardened



Technical Data

Clamping range for pipes (Outer-Ø)	Fastening hole spacing Width – Length	Weight
16 – 55 mm	76 – 98 mm	9 kg
27 – 70 mm	96 – 120 mm	16 kg
27 – 100 mm	120 – 140 mm	27 kg
27 – 100 mm	120 – 140 mm	29 kg

Article No.	Article Description	QTY
4718 120	PARALLEL VICE 120MM/150MM	1
4718 135	PARALLEL VICE 140MM/200MM	1
4718 150	PARALLEL VICE 160MM/225MM	1
4718 175	PARALLEL VICE 180MM/225MM	1

(Jaw width / spread)

Rotary Disc for Vices

- Completely forged from steel
- Rotary disc Art. No. 4718 150 5 is for vice 160 – 180 mm

Article No.	Article Description	QTY
4718 120 5	ROTARY DISC FOR VICE 120MM	1
4718 135 5	ROTARY DISC FOR VICE 140MM	1
4718 150 5	ROTARY DISC FOR VICE 160/180MM	1



Aluminium Magnet Jaws for Vices

Article No.	Article Description	QTY
4718 120 1	(PAIR)ALUMIN.MAGNET JAWS 120MM	1
4718 125 1	(PAIR)ALUMIN.MAGNET JAWS 140MM	1
4718 150 1	(PAIR)ALUMIN.MAGNET JAWS 160MM	1
4718 175 1	(PAIR)ALUMIN.MAGNET JAWS 180MM	1



Windscreen Support

- Adjustable height

Art. No. 5437 10:

- 4 suction pads
- Loading capacity up to 80 kg
- Dimension H x W x D: 90 x 85 x 115 cm

Art. No. 5437 11:

- 2 foamed material coatings
- Continuous padding that is ideal for smaller windows (side windows)
- Loading capacity up to 120 kg
- Dimension H x W x D: 105 x 67 x 34 / 75 cm

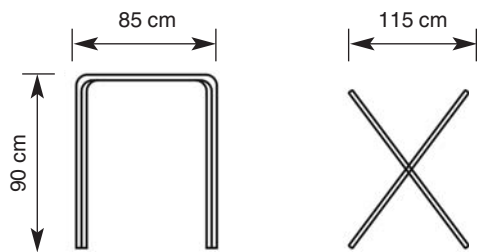

5437 10

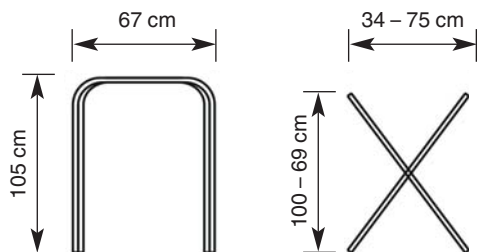

5437 11

Article No.	Article Description	QTY
5437 10	WINDSCREEN SUPPORT STANDARD	1
5437 10 1	RUB.PADS F.WINDSC.SUPP.STANDA.	1
5437 11	WINDSCREEN SUPPORT TRUCK/BUS	1



5437 10



5437 10 1



5437 11

Windscreen Table with Storage Compartment

- 3 adjustable working heights
- 2 rubber sleeves
- full-length insert with storage compartment, ideal for smaller panes of glass (side windows) and painting work
- Load-bearing capacity: up to 70 kg
- Dimensions for lowest and highest working height (H x W x D): 94/104 x 66/49 x 115 cm

Article No.	Article Description	QTY
5437 12	WINDSCR.TABLE W.STOR.COMPARTM.	1

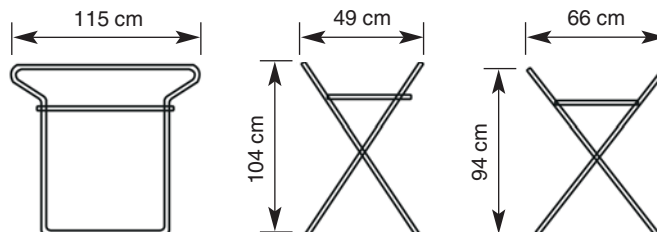

Workshop Organiser Pro

- Complete, extremely stable and robust design for a system of keeping a workshop tidy in body shops and motorbike workshops
- Large choice of storage spaces
- For all sizes of vehicle parts, from motorbike petrol tanks to automobile bumpers
- Greatest possible number of usable surfaces means low space requirements in the workshop
- 6 high quality steerable castors, making it as user-friendly as possible with optimum use of space
- 2 swing-out arms for 'large parts' such as doors, bonnets or windscreens, supported by padded extension bars
- Edge protector on the shelf rims for the safe storage of enamelled parts
- Protective mats in the shelving
- Partition on one half of the shelf for small parts, such as screws and clips
- Identification panel to show which vehicle the parts belong to
- Lateral cantilever arm for keeping seals, etc.

Technical Data

Shelf loading capacity:	Above: 30 kg
	Middle: 30 kg
	Below: 50 kg
Weight:	50 kg

Article No.	Article Description	QTY
9100 35	WORKSHOP ORGANIZER PROFI	1



Workshop Organiser BASE

- Base-body with 4 steerable castors
- 1x shelf and 1x shelf basket
- 2x cantilever arms for fixing a bumper
- Identification panel

Technical Data

Shelf loading capacity:	Above: 30 kg
	Below: 50 kg
Height:	approx. 2,060 mm
Width:	approx. 1,305 mm
Depth:	approx. 860 mm

Article No.	Article Description	QTY
9100 34	WORKSHOP ORGANIZER BASE	1



VARO Barrel Rack for 60 L Barrels

- Robust version due to square tubes (30 × 20 × 2 mm)
- Collecting tray with approx. 70 l volume
- Stackable for any number of barrels on top of each other
- No tilting and positioning of barrels necessary any more
- Storage of canister goods without any problem
- The persistent smooth bottom of the barrel makes a problem-free cleaning possible
- The collecting tray protects your workshop from pollution which can be caused by drops or leakages
- The collecting tray contains 2 recessed grips for comfortable carriage and consists of incombustible PE

Technical Data

Barrel rack H × W × D: 600 × 490 × 640 mm
Collecting tray H × W × D: 290 × 400 × 720 mm



Article No.	Article Description	QTY
9100 111	BARR.RACK W.COLL.TRAY 1 BARREL	1
9100 211	BARR.RACK W.COLL.TRAY 2 BARR.	1
9100 311	BARR.RACK W.COLL.TRAY 3 BARR.	1

Individual Parts VARO Barrel Rack

Article No.	Article Description	QTY
9100 10	BARREL RACK 30/60L	1
9100 11	COLLECTING TRAY F.BARREL RACK	1



Rack for Filling-Star-Machine

- For 60 l brake cleaner plastic and sheet barrel

Technical Data

Dimensions (H x W x D): 810 x 455 x 415 mm

Article No.	Article Description	QTY
9100 32	RACK FOR FILLING-STAR-MACHINE	1



VARO Collecting Tray for 2x 60 L Barrels

- The VARO collecting tray protects your workshop from pollution which can be caused by drops and leakages during decanting of your fluid supplies like oils, brake fluids, antifreeze, cleaning and caring products etc
- The suitable formed floor grid is removable without any tool which makes the emptying of the tray easier
- The load capacity with over 150 kg is higher than needed in practical application (2x 60 l barrel = max. 125 kg)

Technical Data

Dimensions (H x W x D): 290 x 835 x 390 mm

Volume absorption: min. 66 l

Floor grid (H x W x D): 24 x 820 x 380 mm

Weight coupl.: 8.5 kg

Article No.	Article Description	QTY
9100 14	COLLECT.TRAY W. FLOOR GRID TÜV	1



VARO Collecting Tray for 2x 200 L Barrels

- For 2x 200 l or 4x 60 l barrels
- Prototype approved
- Sheet steel, blue lacquered
- Floor grid, zinc-plated
- Ground clearance: 100 mm
- Volume: 225 l

Technical Data

Dimensions (H x W x D): 315 x 1,340 x 860 mm

Article No.	Article Description	QTY
9100 15	OIL COLL. TRAY F.2X 200L BARREL	1



Collecting Tray Flat 55 L

- For oil, petrol, antifreeze, chemicals, and acids
- Extremely flat, only 11 cm high, suitable for deeper positioned vehicles
- Swashing edge is formed inwards, prevents spillage during the transport
- 4 carrying handles for transport
- Outlet device (Ø 70 mm) makes clean emptying of the tray possible

Technical Data

Volume:	approx. 55 litres
Wall strength:	5 mm
Weight:	9 kg
Material:	polyethylene
Length x width x height:	1,030 x 724 x 110 mm



Article No.	Article Description	QTY
9100 19	COLLECTING TRAY FLAT 55L	1

Collecting Tray, Flat 14 L

- For oil, petrol, chemicals and acids
- Extremely flat (13 cm) for deeper positioned vehicles
- Absorption volume approx. 14 l
- Guaranteed break-proof (10 years guarantee)
- Outlet device makes clean emptying of the tray possible
- Can also be used singly due to 2 carrying handles
- Swashing edge is formed inwards, prevents spillage during the transport

Technical Data

Volume:	approx. 14 l
Weight:	2 kg
Height:	13 cm
Diameter:	49 cm
Material:	PE, biodegradable



Article No.	Article Description	QTY
9100 18	COLLECTING TRAY FLAT 14L	1

Multi-Purpose Tray, Plastic

- Suitable for oil, petrol, different acids and chemicals
- With medium socket for small parts cleaning
- Pointed grommet for safe decanting

Technical Data

Volume:	9 l
Weight:	1.0 kg
Measurements HxLxW	15 x 32 x 32 cm
Material:	polyethylene



Article No.	Article Description	QTY
5421 9	MULTI-PURPOSE TRAY, PLASTIC 9L	1

Axle Oil Collection Pan - Truck

- For collecting the planetary drive oil of the driving axles
- Suitable for different wheel rim diameters
- Impact-resistant polyethylene plastic, resistant to gasoline, oil, chemicals, acids and solvents
- With two handles and one discharge

Technical Data

Capacity:	3 l
Dimension (B x W x D):	315 x 155 x 240 mm
Weight:	417 g



Article No.	Article Description	QTY
9100 3000	OIL SUMP TRUCK AXLE 3L	1

Socket Bar System

- 4 different lengths
- Universal and can be assembled with 1/4", 3/8", 1/2" spring clips

Article No.	Article Description	QTY
4498 158	SOCKET BAR 158MM WITHOUT CLIP	1
4498 241	SOCKET BAR 241MM WITHOUT CLIP	1
4498 300	SOCKET BAR 300MM WITHOUT CLIP	1
4498 400	SOCKET BAR 400MM WITHOUT CLIP	1
4498 14	1/4" SPRING CLIP	10
4498 38	3/8" SPRING CLIP	e 10
4498 12	1/2" SPRING CLIP	e 10



TX Socket Wrench Inserts

Art. No. 4495 4440:

- TX socket wrench coupling 1/4"
E 4, 5, 6, 7, 8, 10

Art. No. 4495 4441:

- TX socket wrench coupling 3/8"
E 5, 6, 7, 8, 10, 11, 12, 14, 16

Art. No. 4495 4442:

- TX socket wrench couplings 1/2"
E 10, 11, 12, 14, 16, 18, 20, 24

Article No.	Article Description	QTY
4495 4440	1/4" TX SOCKET WRENCH BAR	1
4495 4441	3/8" TX SOCKET WRENCH BAR	1
4495 4442	1/2" TX SOCKET WRENCH BAR	1



TX Screwdriver Inserts

Art. No. 4495 4455:

- TX screwdriver bar coupling 1/4"
TX 10, 15, 20, 25, 27, 30 with head access hole drilling

Art. No. 4495 4456:

- TX screwdriver bar coupling 3/8"
TX 10, 15, 20, 25, 27, 30, 40, 45

Art. No. 4495 4457:

- TX screwdriver bar coupling 1/2"
TX 20, 25, 27, 30, 40, 45, 50, 55

Article No.	Article Description	QTY
4495 4455	1/4" TX SCREWDRIVER INSERT BAR	1
4495 4456	3/8" TX SCREWDRIVER INSERT BAR	1
4495 4457	1/2" TX SCREWDRIVER INSERT BAR	1



XZN Screwdriver Inserts

- XZN screwdriver bar 1/2"
5, 6, 8, 10, 12
8 x 100, 10 x 100, 12 x 100 mm

Article No.	Article Description	QTY
4495 4460	1/2" XZN SCREWDRIVER INSERT BAR	1



Socket Set 5 Star, 1/4"

- 1/4" socket inserts, 5 star with head access hole drilling, size 10, 15, 20, 25, 27, 30, 40

Application examples:

- VW/Audi, Mercedes-Benz cars, Ford, Volvo (generator, engine control and door covering) Mercedes-Benz truck (e.g. Actros; Atego)
- Agricultural engine injection pumps



Article No.	Article Description	QTY
4495 4401	1/4" SOCKET SET 5 SET HEAD DR.	1

Hexagon Socket–Screwdriver Inserts

Art. No. 4495 4450:

- Hexagon socket screwdriver bar 1/4" SW 1,5, 2, 2,5, 3, 4, 5, 6, 8

Art. No. 4495 4451:

- Hexagon socket screwdriver bar 3/8" SW 3, 4, 5, 6, 8, 10

Art. No. 4495 4452:

- Hexagon socket screwdriver 1/2" SW 4, 5, 6, 7, 8, 10, 12

Art. No. 4495 4452 1:

- Hexagon socket screwdriver bar 1/2" long SW 5, 6, 7, 8, 10



Article No.	Article Description	QTY
4495 4450	1/4"HEX.SOCKET SCREWDRIVER BAR	1
4495 4451	3/8"HEX.SOCKET SCREWDRIVER BAR	1
4495 4452	1/2"HEX.SOCKET SCREWDRIVER BAR	1
4495 4452 1	1/2"HEX.SOCK.SCREWDR.BAR LONG	1

Power Socket Set, 1/2" **ECO**

- Including Mercedes-Benz special socket, size 17

Article No.	Article Description	QTY
4495 4571	POWER SOCKET SET 1/2" ECO	1

Contents:

- 1x MS 17, 1x size 15, 2x size 17, 2x size 19, 1x size 21, 1x size 22



Magnetic Toolbar

- Can be mounted on the wall, tool trolley etc.
- Make clear overview of tools possible

Art. No. 4990 10:

- Light version
- Dimension H x W x D: 40 x 500 x 24 mm
- Including fixing material

Art. No. 4990 11:

- Heavy version
- Dimension H x W x D: 18 x 610 x 25 mm



4990 10

Article No.	Article Description	QTY
4990 10	MAGNET.TOOLBAR LIGHT VERS.50CM	1
4990 11	MAGNET.TOOLBAR HEAVY VERS.61CM	1



4990 11

Magnetic Tool Holder

- With two magnets for the fixation on ferrous surfaces
- Pins for attaching socket wrenches
- The Ring in the middle is suitable for a 1/2" impact wrench
- The two noses at the bottom can be used for attaching e.g. torque wrenches
- Size LxW: 390 x 135 mm
- Load capacity: 15 kg



Article No.	Article Description	QTY
4498 1	TOOL HOLDER WITH 2 MAGNETS	1

Magnet Shell Stainless Steel Ø 150 mm

- Stainless steel shell for storing small parts and tools
- Plastic layered magnet to prevent damages on painted surfaces
- Magnetic objects are being hold even in inclined position due to magnetic force

Article No.	Article Description	QTY
4990 12	MAGNET SHELL ST.STEEL Ø150	1



Magnetic Shell Stainless Steel 140 x 240 mm

- Stainless steel shell for storing small parts and tools
- 2 plastic layered magnets to prevent damages on painted surfaces
- Magnetic objects are being hold even in inclined position due to magnetic force

Article No.	Article Description	QTY
4990 13	MAGNET SHELL ST.STEEL 140X240	1



Magnetic Shell Plastic Ø 150 mm

- Plastic shell for storing small parts and tools
- Plastic layered magnet to prevent damages on painted surfaces
- Magnetic objects are being hold even in inclined position due to magnetic force

Article No.	Article Description	QTY
4990 14	MAGNET SHELL PLASTIC Ø150MM	1



Assembly Board

- Practical board for comfortable works under the vehicle
- 6 oil-resistant and low-noise steering rollers with tread rubber
- Cushioned headrest
- Including tool trays
- With cut out arms for optimum elbowroom
- Load capacity: 120 kg

Article No.	Article Description	QTY
5436 15	PROF.ASSEMBLY BOARD	1
5436 15 1	STEERING ROLLER FOR PROF.BOARD	1



Creeper Board and Folding Seat

For comfortable working at and under the vehicle

- 2 in 1 – creeper board and folding seat
- Quick and easy adjustment of both functions
- Cushioned lying surface, yellow head
- Stable, robust steel frame with 6 big rollers, Ø 63 mm
- Weight: 9 kg
- Load capacity up to 150 kg
- Dimensions L x W x H: Lying position 1, 198 x 450 x 130 mm, sitting height 420 mm, sitting surface 300 x 310 mm

Article No.	Article Description	QTY
5436 3	CREEPER BOARD AND FOLDING SEAT	1
5436 3 1	REPL.WHEEL HEAD AREA	1
5436 3 2	REPL.WHEEL LYING AREA	1



Roller Stool

- With hydraulic height adjustment (360–475 mm) and 5 steering rollers (2x with locking devices)
- Max. load: 110 kg

Article No.	Article Description	QTY
5436 1	ASSEMBLY STOOL HYDR. 360-480MM	1
5436 7	SPARE WHEE.WITHO.BRAKE F.STOOL	1



VAROBOXX

- Mobile logistics in four sizes
- Made of shock- and impact-proof ABS polymer
- Two robust closures
- Carrying handle of plastic integrated in the cover
- Completely compatible with each other
- Without clicking a complicated locking system
- Can be quickly separated from each other
- Available empty or as equipped sets
- Extensive accessories for individual configuration
- Industry-specific inserts for any size

- Securing the VAROBOXXES on Sortimo shelves or the MultiSlide pull-out tray
- Can be used with separate adapter plates as the smallest self-contained vehicle rack in the transporter
- Compatible with Sortimo and Bosch L-Boxx
- Max. load of individual box: 12 kg
- Max. load, carrying handle: 40 kg (when the tower is carried using the carrying handle)
- Approved load on cover: 85 kg

VAROBOXX 1

- Type 102
- Outer dimensions (WxDxH): 442 × 357 × 117 mm
- Inner dimensions (WxDxH): 378 × 313 × 71 mm
- Weight: 2.1 kg



Article No.	Article Description	QTY
9003 1	VAROBOXX SIZE:1 EMPTY	1

VAROBOXX 2

- Type 136
- Outer dimensions (WxDxH): 442 × 357 × 151 mm
- Inner dimensions (WxDxH): 378 × 311 × 107 mm
- Weight: 2.2 kg



Article No.	Article Description	QTY
9003 2	VAROBOXX SIZE:2 EMPTY	1

VAROBOXX 3

- Type 238
- Outer dimensions (WxDxH): 442 × 357 × 252 mm
- Inner dimensions (WxDxH): 378 × 306 × 209 mm
- Weight: 2.8 kg



Article No.	Article Description	QTY
9003 3	VAROBOXX SIZE:3 EMPTY	1

VAROBOXX 4

- Type 374
- Outer dimensions (WxDxH): 442 × 357 × 389 mm
- Inner dimensions (WxDxH): 378 × 296 × 345 mm
- Weight: 3.4 kg



Article No.	Article Description	QTY
9003 4	VAROBOXX SIZE:4 EMPTY	1

VAROBOXX LT 2

- Made from shock- and impact-resistant ABS plastic
- Compatible with all VAROBOXXES
- With carrying attachment
- Open container with quick access to all items
- Ideal for cumbersome items
- Outer measurements (WxDxH): 442 × 357 × 151 mm
- Inner measurements (WxDxH): 378 × 311 × 107 mm
- Weight: 2.3 kg



Article No.	Article Description	QTY
9003 8	VAROBOXX LT SIZE: 2	1

VAROBOXX LT 3

- Made from shock- and impact-resistant ABS plastic
- Compatible with all VAROBOXXES
- With carrying attachment
- Open container with quick access to all items
- Ideal for cumbersome items
- Outer measurements (WxDxH): 442 × 357 × 252 mm
- Inner measurements (WxDxH): 378 × 306 × 209 mm
- Weight: 2.9 kg



Article No.	Article Description	QTY
9003 9	VAROBOXX LT SIZE: 3	1

VAROBOXX 2 with Tool Organizer

- Tool organizer in cover with 10 pockets and holding strap
- Tool organizer in the bottom with 8 slots on the front and 11 slots on the back
- With practical carrying strap
- Professional tool box in VAROBOXX system
- Compatible with VAROMOBIL vehicle equipment and VAROMOVE



Article No.	Article Description	QTY
9003 2 1	VAROBOXX SIZE:2 W.TOOL ORGANIZ	1

(Tools not included in delivery)

VAROBOXX Replacement Parts

Article No.	Article Description	QTY
9005 51	SIDE HANDLE VAROBOXX1	1
9005 52	SIDE HANDLE VAROBOXX2-4	1
9005 53	FRONT HANDLE VAROBOXX	1
9005 54	COVER HANDLE VAROBOXX	1
9005 55	(COUPLE)FASTENINGS VAROBOXX	1
9005 56	HOLDER+SPRING VAROBOXX	1



Accessories **VAROBOXX**

Trolley

- Easy and quick height adjustment due to button
- Extra big profile wheel for exterior works
- Small folding measure
- Big transport space
- Sponge rubber covered grips with foldable extra grips
- Mobile and safe at the same time

Technical Data

Load capacity:	200 kg
Dead weight:	10.4 kg
Dimensions (L x W x H)	
- folded up:	97 x 595 x 1,010 mm
- opened:	600 x 620 x 1,255 mm
Platform size:	590 x 390 mm



Article No.	Article Description	QTY
4990 200 10	TROLLEY 200KG FOLDABLE	1

Transport Roller **VAROBOXX**

- Measurements (LxWxH): 646 x 492 x 184 mm
- Practical mobile platform for all VAROBOXXES – they can simply be clicked together
- Plastic with four castors, two lockable castors
- Maximum load: 100 kg
- Weight: 3.8 kg



Article No.	Article Description	QTY
9005 100	TRANSPORT ROLLER 100KG VAROBOX	1

Mounting Plate, Small **VAROBOXX**

- measurements (LxWxH): 494 x 50 x 612 mm
- The VAROBOXXES are secured with belts
- material: steel sheet
- weight: 3.9 kg
- suitable for all VAROBOXXes



Article No.	Article Description	QTY
9006 1	MOUNTING PLATE SMALL VAROBOX	1

Mounting Plate, Large **VAROBOXX**

- Measurements (LxWxH): 494 x 50 x 918 mm
- The VAROBOXXES are secured with belts
- Material: steel sheet
- Weight: 5.7 kg
- Suitable for all VAROBOXXes

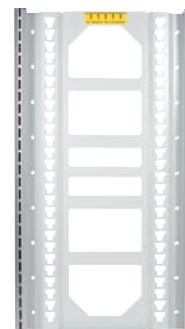

Article No.	Article Description	QTY
9006 2	MOUNTING PLATE BIG VAROBOX	1

Belt for Mounting Plate **VAROBOXX**

- For secure attachment of VAROBOXXES to the mounting plate
- Suitable for all VAROBOXXES

Article No.	Article Description	QTY
9006 4	BELT F.MOUNTING PLATE VAROBOXX	1



Work Surface, Small **VAROBOXX**

- Measurements (LxWxH): 500 × 700 × 18 mm
- Lightweight, flexible and stable multiplex worktop
- Built-in lock for fixing the worktop
- With 1 tower VAROBOXXES on VAROBOXX roller (ordered separately) the workbench is built quickly
- Height adjustment by number of VAROBOXXES

Article No.	Article Description	QTY
9005 50 70	WORK SURFACE SMALL VAROBOXX	1



Work Surface, Large **VAROBOXX**

- Measurements (LxWxH): 1,400 × 700 × 18 mm
- Lightweight, flexible and stable multiplex worktop
- Built-in lock for fixing the worktop
- With 2 towers VAROBOXXES on VAROBOXX roller (ordered separately) the bench is constructed quickly
- Adjustable in height by number of VAROBOXXES

Article No.	Article Description	QTY
9005 140 70	WORK SURFACE LARGE VAROBOXX	1



Holder Prosafe **VAROBOXX**

- The VAROBOXX holder allows you to click the VAROBOXX, VAROBOXX LS, VAROBOXX Rack down on the floor
- The load can be secured during transport using a lashing strap thanks to the integrated lashing point
- Suitable lashing straps: Art. No.: 9006 4 (approx. 1.5 m), 9012 45 1 (approx. 3 m)
- Scope of delivery: 2 pieces

Article No.	Article Description	QTY
9006 5	HOLDER PROSAFE VAROBOXX	1



Work Surface for Lid **VAROBOXX**

- Stable multiplex worktop 14 mm thick
- Can be fitted to the lid of every VAROBOXX, no tools needed
- Divisible for transport to the VAROBOXX
- Weight: 1.45 kg
- Suitable for all VAROBOXXES



Article No.	Article Description	QTY
9005 0 1	WOOD.WORKTOP 2-PIECE VAROBOX	1

Seat Cushion for Lid **VAROBOXX**

- Suitable for all VAROBOXXES

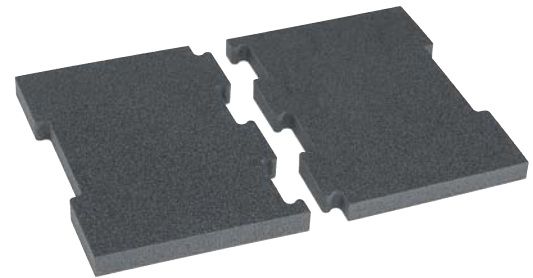

Article No.	Article Description	QTY
9005 0 13	SEAT CUSHION FOR LID VAROBOXX	1

Basic Individual Set **VAROBOXX**

- Made-to-measure storage of equipment and tools

Article No.	Article Description	QTY
9005 1	INDI.BASIC SET VAROBOX 1	1
9005 2	INDIV.BASIC SET VAROBOX 2	1
9005 3	INDIV.BASIC SET VAROBOX 3	1
9005 4	INDIV.BASIC SET VAROBOX 4	1

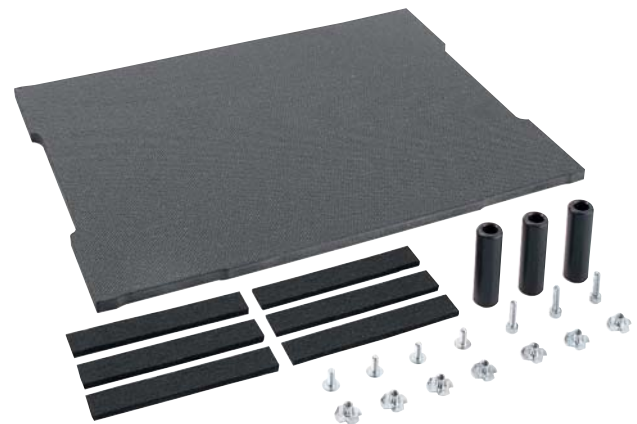

Individual Adhesive Felt **VAROBOXX**

- Dimensions (L x W x H): 120 x 20 x 4 mm
- Contents: 6 strips
- Dampers to prevent damage to the tool or machine
- Elements may be glued individually
- Suitable for all VAROBOXXES

Article No.	Article Description	QTY
9005 0 3	INDIV.GLUE FELT VAROBOX	1



Individual Screw Set **VAROBOXX**

- To supplement the basic set
- To screw the inset boxes or accessories
- Suitable for all VAROBOXXES

Article No.	Article Description	QTY
9005 0 4	INDIV.SCREW SET VAROBOX	1



Individual Separating Sheet, Short **VAROBOXX**

- Measurements (W x H): 200 x 62 mm
- To supplement the basic set
- Suitable for all VAROBOXXES

Article No.	Article Description	QTY
9005 0 5	INDI.PART.PLATE 62X200 VAROBOX	1

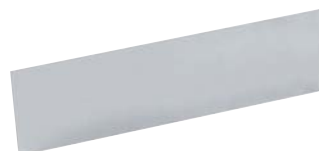

Individual Separating Sheet, Long **VAROBOXX**

- Measurements (W x H): 400 x 62 mm
- To supplement the basic set
- Suitable for all VAROBOXXES

Article No.	Article Description	QTY
9005 0 6	INDI.PART.PLATE 62X400 VAROBOX	1



Individual Holder for Separating Sheet **VAROBOXX**

- To supplement the basic set
- Suitable for all VAROBOXXES

Article No.	Article Description	QTY
9005 0 9	INDI.PART.PLATE HOLDER VAROBOX	1



Individual Position Retainer **VAROBOXX**

- Measurements (L x Ø): 60 x 18 mm
- Position holder for use with the basic set
- To fix the contents
- Suitable for all VAROBOXXES

Article No.	Article Description	QTY
9005 0 10	INDI.POSITION RETAINER VAROBOX	1



Lid Insert **VAROBOXX**

- Measurements (LxWxH): 405 × 30 × 333 mm
- Lid insert made of hard foam to protect the contents of your inset boxes or thermoforming operations against unintentional mixing during transport
- Suitable for all VAROBOXXES

Article No.	Article Description	QTY
9004 0 1	COVER INLAY VAROBOXX	1



Tool Card **VAROBOXX**

- Measurements (LxWxH): 380 × 20 × 315 mm
- To be mounted in the lid of the VAROBOXX, with elastic loops and pockets for tools
- Suitable for all VAROBOXXES

Article No.	Article Description	QTY
9004 0 2	DOCUMENT CARD VAROBOXX	1



Document Card **VAROBOXX**

- Measurements (LxWxH): 380 × 20 × 315 mm
- The document card enables accommodation of calculator, pens, etc. and documents up to size A4
- Suitable for all VAROBOXXES

Article No.	Article Description	QTY
9004 0 3	DOCUMENT CARD VAROBOXX	1



Transparent Bag **VAROBOXX**

- Measurements (LxWxH): 335 × 2 × 206 mm
- Transparent pouch to accommodate up to size DIN A5 operation/use instructions on the underside of the cover
- Suitable for all VAROBOXXES

Article No.	Article Description	QTY
9004 0 4	TRANSPARENT BAG VAROBOXX	1



Universal Adapter Tray **VAROBOXX**

- Suitable for all systainer inserts and deep-drawn components
- Supports a standardised case system for all machines
- Maximum flexibility for integration of your machines in the VAROBOXX
- Not suitable for inserts with small parts
- Suitable for VAROBOXX 2, 3 and LS



Article No.	Article Description	QTY
9004 0 5	UNIV.ADAPTER TRAY VAROBOXX	1

Shoulder Strap **VAROBOXX**

- Ideal supplement for VAROBOXX 1 and 2
- Adjustable strap, from 0.80 m to 1.50 m
- Incl. supporting bracket and assembly instructions



Article No.	Article Description	QTY
9005 0 14	SHOULDER STRAP VAROBOXX	1

Customisable EPP Insert **VAROBOXX 1**

- Consisting of 4 pimped, 15 mm EPP sheets for individual self-cutting
- Insert is suitable for large and small filligree contours, whereby the intersections can vary through several levels
- Set is supplied with instructions and cutter
- Suitable for VAROBOXX 1



Article No.	Article Description	QTY
9004 1 6	CUSTOMIS.EPP INSERT VAROBOXX1	1

Pre-cut Foam **VAROBOXX 1**

- Measurements (LxWxH): 405 × 315 × 50 mm
- Pre-perforated foam for VAROBOXX
- Individual adjustment of the insert
- Allows the safe transport of valuable items
- Suitable for VAROBOXX 1



Article No.	Article Description	QTY
9004 1 3	PRE-CUT FOAM VAROBOXX1	1

Anti-slip Mat **VAROBOXX 1+2**

- Measurements (LxWxH): 397 × 307 × 4 mm
- Soft inlay mat made of rubber
- Protects the VAROBOXX and the material on the floor against damage during transport
- Suitable for VAROBOXX 1 and 2



Article No.	Article Description	QTY
9005 0 12	ANTI-SKID MAT VAROBOX 1+2	1

Deep Drawn Insert 5 Compartments **VAROBOXX 1**

- measurements (LxWxH): 405 × 315 × 62 mm
- tray for small parts made from deep-drawn plastic with 5 compartments
- reasonably priced sorting opportunity for the VAROBOXX
- suitable for VAROBOXX 1



Article No.	Article Description	QTY
9004 1 5	DEEP DRAWN INS.5COMP.VAROBOXX1	1

Deep Drawn Insert 8 Compartments **VAROBOXX 1**

- measurements (LxWxH): 405 × 315 × 62 mm
- tray for small parts made from deep-drawn plastic with 8 compartments
- reasonably priced sorting opportunity for the VAROBOXX
- suitable for VAROBOXX 1



Article No.	Article Description	QTY
9004 1 8	DEEP DRAWN INS.8COMP.VAROBOXX1	1

Deep Drawn Insert 12 Compartments **VAROBOXX 1**

- measurements (LxWxH): 405 × 315 × 62 mm
- tray for small parts made from deep-drawn plastic with 12 compartments
- reasonably priced sorting opportunity for the VAROBOXX
- suitable for VAROBOXX 1



Article No.	Article Description	QTY
9004 1 12	DEEP DRAWN INS.12COM.VAROBOXX1	1

Inset Box Set, red **VAROBOXX 1**

- 2x inset box U3, grey including 6 partitions
- 30x inset box A3, red
- suitable for VAROBOXX 1

Article No.	Article Description	QTY
9004 1 21	INSET BOX SET RED VAROBOXX1	1

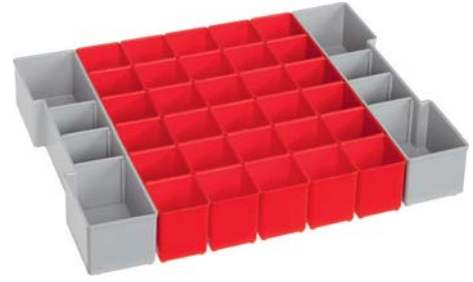

Inset Box Set, yellow **VAROBOXX 1**

- 2x inset box U3, grey including 6 partitions
- 15x inset box B3, yellow
- suitable for VAROBOXX 1

Article No.	Article Description	QTY
9004 1 25	INSET BOX SET YELLOW VAROBOXX1	1

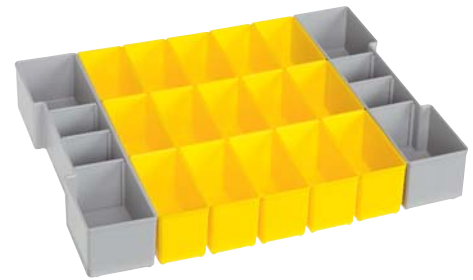

Inset Box Set, yellow/blue **VAROBOXX 1**

- 2x inset box U3, grey including 6 partitions
- 3x inset box B3, yellow
- 6x inset box C3, blue
- suitable for VAROBOXX 1

Article No.	Article Description	QTY
9004 1 22	INSET BOX SET YE/BU VAROBOXX1	1

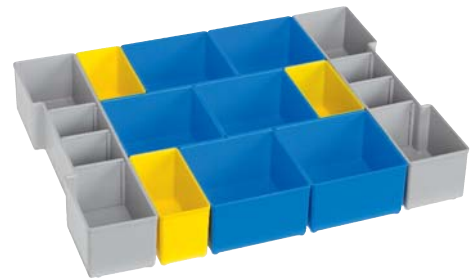

Inset Box Set, blue/light green **VAROBOXX 1**

- 2x inset box U3, grey including 6 partitions
- 3x inset box C3, blue
- 3x inset box D3, green
- suitable for VAROBOXX 1

Article No.	Article Description	QTY
9004 1 26	INS.BOX SET BU/L.GN VAROBOXX1	1



Inset Box Set, light green **VAROBOXX 1**

- 2x inset box U3, grey including 6 partitions
- 5x inset box D3, green
- suitable for VAROBOXX 1

Article No.	Article Description	QTY
9004 1 23	INS.BOX SET L.GREEN VAROBOXX1	1



Inset Box Set, orange/yellow **VAROBOXX 1**

- 2x inset box U3, grey including 6 partitions
- 7x inset box F3, orange
- 1x inset box B3, yellow
- suitable for VAROBOXX 1



Article No.	Article Description	QTY
9004 1 27	INS.BOX SET OG/YE VAROBOXX1	1

Inset Box Set, dark green/yellow/red **VAROBOXX 1**

- 2x inset box U3, grey including 6 partitions
- 2x inset box G3, dark green
- 2x inset box B3, yellow
- 2x inset box A3, red
- suitable for VAROBOXX 1

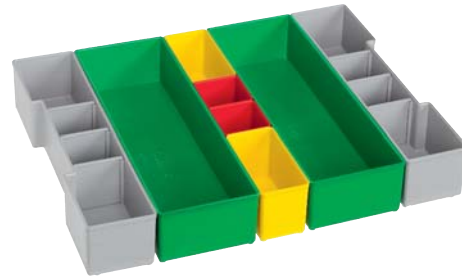

Article No.	Article Description	QTY
9004 1 24	INS.BOX SET GN/YE/RDVAROBOXX1	1











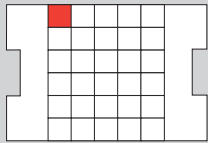
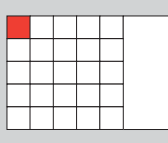
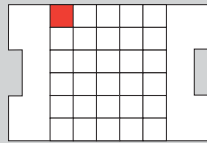

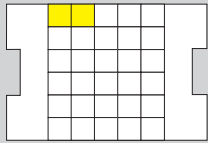
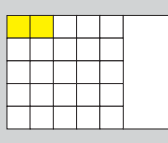
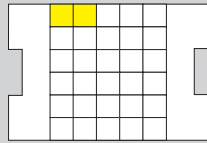

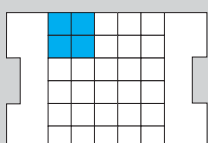
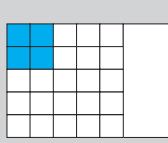
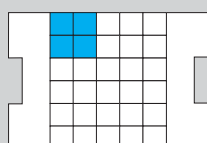
Inset Box Set, all colours **VAROBOXX 1**

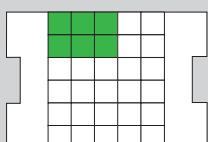
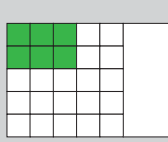
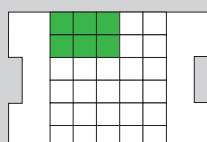
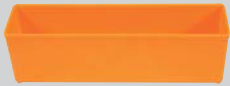
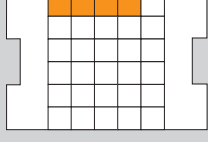
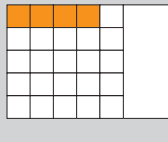
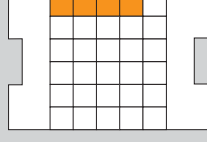
- 2x inset box U3, grey including 6 partitions
- 2x inset box A3, red
- 3x inset box B3, yellow
- 2x inset box C3, blue
- 1x inset box D3, light green
- 2x F3 inset box , orange
- suitable for VAROBOXX 1

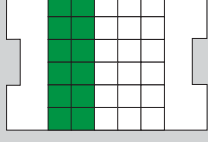
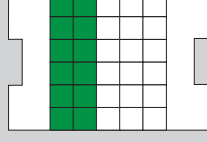

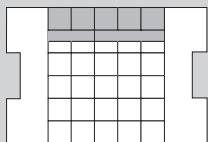
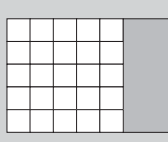
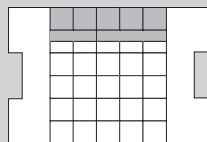
Article No.	Article Description	QTY
9004 1 28	INS.BOX SET ALL COL.VAROBOXX1	1

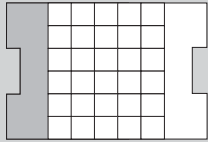
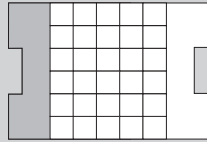
Inset Box matrix

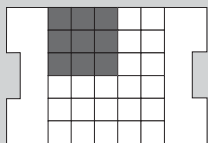
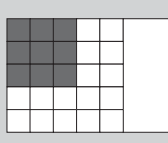
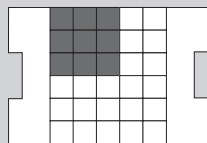
Article No.		Dimensions mm	VAROBOXX 1+2	VAROiBOXX	Inset Box insert VAROBOXX 3+4
Inset Box, red					
9004 1 5 5		W x D x H: 52 x 52 x 63			
Inset Box, yellow					
9004 1 5 10		W x D x H: 104 x 52 x 63			
Inset Box, blue					
9004 1 10 10		W x D x H: 104 x 104 x 63			
Inset Box, light green					
9004 1 10 15		W x D x H: 156 x 104 x 63			
Inset Box, orange					
9004 1 5 20		W x D x H: 208 x 52 x 63			
Inset Box, dark green					
9004 1 10 30		W x D x H: 312 x 104 x 63			
Inset Box, grey					
9008 75 260		W x D x H: 78 x 260 x 63			
Inset Box lateral grey					
9004 1 0		W x H: 312 x 63			
Cutting Disc Spindle					
9004 1 2		W x D x H: 156 x 156 x 63			

Inset Box, red **VAROBOXX 1**

- Type A3
- measurements (WxL): 5 x 5 cm
- suitable for VAROBOXX 1



Article No.	Article Description	QTY
9004 1 5 5	INSET BOX RED 5X5CM VAROBOXX1	1

Inset Box, yellow **VAROBOXX 1**

- Type B3
- measurements (WxL): 5 x10 cm
- suitable for VAROBOXX 1



Article No.	Article Description	QTY
9004 1 5 10	INS.BOX YELL.5X10CM VAROBOXX 1	1

Inset Box, blue **VAROBOXX 1**

- Type C3
- measurements (WxL): 10 x10 cm
- suitable for VAROBOXX 1



Article No.	Article Description	QTY
9004 1 10 10	INS.BOX BLUE10X10CM VAROBOXX 1	1

Inset Box, light green **VAROBOXX 1**

- Type D3
- measurements (WxL): 10 x 15 cm
- suitable for VAROBOXX 1

Article No.	Article Description	QTY
9004 1 10 15	INSETB.L-GR.10X15CM VAROBOXX 1	1



Inset Box, orange **VAROBOXX 1**

- Type F3
- measurements (WxL): 5 x 20 cm
- suitable for VAROBOXX 1

Article No.	Article Description	QTY
9004 1 5 20	INS.BOX ORAN.5X20CM VAROBOXX 1	1



Inset Box, dark green **VAROBOXX 1**

- Type G3
- measurements (WxL): 10 x 30 cm
- suitable for VAROBOXX 1

Article No.	Article Description	QTY
9004 1 10 30	INSETB.D-GR.10X30CM VAROBOXX 1	1



Side Inset Box, grey **VAROBOXX 1**

- Type U3
- suitable for VAROBOXX 1

Article No.	Article Description	QTY
9004 1 0	INSET BOX GREY SIDE.VAROBOXX 1	1



Partition Inset Box, side, grey **VAROBOXX 1**

- Type U3 TW
- suitable for side inset box, grey in VAROBOXX 1

Article No.	Article Description	QTY
9004 1 0 1	DIVI.INSET BOX SIZE VAROBOXX 1	e 200



Cutting Disc Inset Box **VAROBOXX 1**

- Suitable for VAROBOXX 1, VAROiBOXX and VAROBOXX LS drawer
- With Euro-standard hole for POS wall
- Suitable for all discs up to 125 mm Ø
- Dimensions (W × D × H): 156 × 156 × 63 mm

Article No.	Article Description	QTY
9004 1 2	CUTTING DISC INSETB.VAROBOXX1	1



Burner Nozzle Insert **VAROBOXX**

- Measurements (WxDxH): 405 × 315 × 50 mm
- Holes: 22 mm Ø
- Pre-perforated foam material facilitates the safe transportation of fragile contents
- Suitable for VAROBOXX 1

Article No.	Article Description	QTY
9004 1 4	BURNER NOZZLE INSERT VAROBOXX	1



Customisable EPP Insert **VAROBOXX 2 and LS**

- Consisting of 6 pimpled, 15 mm EPP sheets for individual self-cutting
- Insert is suitable for large and small filigree contours, whereby the intersections can vary through several levels
- Set is supplied with instructions and cutter
- Suitable for VAROBOXX 2 and LS

Article No.	Article Description	QTY
9004 2 13	CUSTOMIS.EPP VAROBOXX2	1



Deep Drawn Insert 4 Compartments **VAROBOXX 2**

- tray for small parts made from deep-drawn plastic
- with 4 compartments
- reasonably priced sorting opportunity for the VAROBOXX
- suitable for VAROBOXX 2 and VAROBOXX LS



Article No.	Article Description	QTY
9004 2 7	DEEP DRAWN INS.4COMP.VAROBOXX2	1

Deep Drawn Insert 6 Compartments **VAROBOXX 2**

- tray for small parts made from deep-drawn plastic
- with 6 compartments
- reasonably priced sorting opportunity for the VAROBOXX
- suitable for VAROBOXX 2 and VAROBOXX LS



Article No.	Article Description	QTY
9004 2 9	DEEP DRAWN INS.6COMP.VAROBOXX2	1

Deep Drawn Insert 8 Compartments **VAROBOXX 2**

- tray for small parts made from deep-drawn plastic
- with 8 compartments
- reasonably priced sorting opportunity for the VAROBOXX
- suitable for VAROBOXX 2 and VAROBOXX LS



Article No.	Article Description	QTY
9004 2 8	DEEP DRAWN INS.8COMP.VAROBOXX2	1

Laptop Insert **VAROBOXX 2**

- suitable for laptops up to 365 × 270 mm (approx. 15.4" depending on design)
- below the laptop is space for power supply, mouse, CDs, etc.
- suitable for VAROBOXX 2



Article No.	Article Description	QTY
9004 2 1	LAPTOP INSERT VAROBOXX2	1

Pre-cut Foam **VAROBOXX 2**

- measurements (LxWxH): 405 x 315 x 85 mm
- pre-perforated foam
- option to customize the foam insert to the content
- suitable for VAROBOXX 2

Article No.	Article Description	QTY
9004 2 3	PRE-CUT FOAM VAROBOXX2	1



Cylinder Saw Insert **VAROBOXX 2**

- suitable for VAROBOXX 2
- prepared for hole saws Ø 19/22/30/35/40/44/51/60/68/76/83/92/95/102 and 114 mm
- compartment for shank AS 2, AS 3 and centre drill 6.3 x 80 mm

Article No.	Article Description	QTY
9004 2 5	CYLINDER SAW INSERT VAROBOXX2	1



Angle Grinder Insert **VAROBOXX 2**

- suitable for VAROBOXX 2
- cut-off wheel tray for 115 mm blades with removable screening for 125 mm shelf depth 40 mm
- compartment for guard, auxiliary handle and keys
- **note: suitable for FÖRCH angle grinder, and many other types!**

Article No.	Article Description	QTY
9004 2 2	ANGLE GRINDER INSERT VAROBOXX2	1



Drilling Machine Insert **VAROBOXX 2**

- suitable for VAROBOXX 2
- with compartment for drills and individual drill cartridge
- **note: suitable for FÖRCH impact drill, other types possible**

Article No.	Article Description	QTY
9004 2 10	DRILLING MACH.INSERT VAROBOXX2	1



Anti-slip Mat **VAROBOXX 3**

- measurements (LxWxH): 390 × 301 × 4 mm
- soft inlay mat made of rubber
- protects the VAROBOXX and the material on the floor against damage during transport
- suitable for VAROBOXX 3



Article No.	Article Description	QTY
9005 3 1	ANTI-SKID MAT VAROBOX 3	1

Inset Box Insert **VAROBOXX 3+4**

- suitable for VAROBOXX 3 and 4 in conjunction with partition panel frame Art. No. 9004 3 3

Art. No. 9004 3 1

- inset box insert with inset boxes

Art. No. 9004 3 2

- inset box inserts without inset boxes



9004 3 1

Article No.	Article Description	QTY
9004 3 1	INS.BOX W.INS.BOX.VAROBOXX3+4	1
9004 3 2	INS.BOX INS.W.BOX VAROBOXX3+4	1

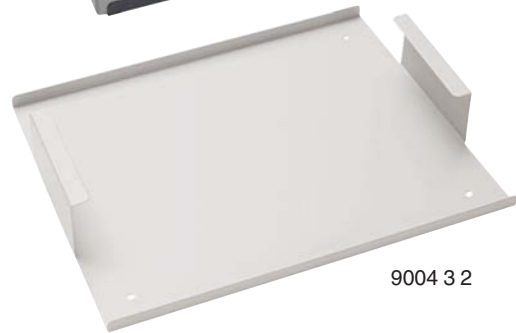

9004 3 2

Partition Panel Frame **VAROBOXX 3+4**

- Partition panel frame for individual division of VAROBOXX using partition panels
- suitable for VAROBOXX 3 and 4

Article No.	Article Description	QTY
9004 3 3	PART.PLATE FRAME VAROBOXX 3+4	1



Slot Pass Partition Plate, short **VAROBOXX 3**

- measurements (WxH): 283 × 130mm
- supplied with 4 clips
- suitable for VAROBOXX 3

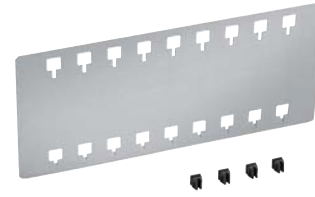

Article No.	Article Description	QTY
9004 3 4	SLOT PASS PART.SHORT VAROBOXX3	1

Slot Pass Partition Plate, long **VAROBOXX 3**

- measurements (WxH): 354 × 130 mm
- supplied with 4 clips
- suitable for VAROBOXX 3

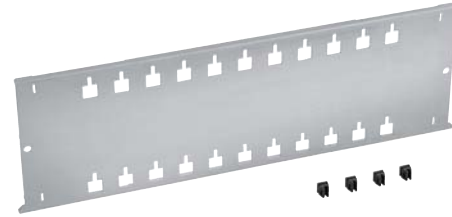

Article No.	Article Description	QTY
9004 3 5	SLOT.PLATE LONG VAROBOXX 3	1

Pass Partition Plate, short **VAROBOXX 3**

- measurements (WxH): 137 × 130 mm
- supplied with 4 clips
- suitable for VAROBOXX 3



Article No.	Article Description	QTY
9004 3 6	PASS PART.PL.SHORT VAROBOXX3	1

Pass Partition Plate, long **VAROBOXX 3**

- measurements (WxH): 173 × 130 mm
- supplied with 4 clips
- suitable for VAROBOXX 3



Article No.	Article Description	QTY
9004 3 7	PASS PART.PL.LONG VAROBOXX3	1

Thermo Insert **VAROBOXX 3**

- measurements (LxWxH): 336 × 249 × 154 mm
- thermo insert for storing and transporting temperature-sensitive materials such as composites and other construction chemicals
- at a starting temperature of 20°C and an ambient temperature of -10° the internal temperature of the full VAROBOXX does not about fall below 0°C for 10 hours
- thermo inlay consists of insulating EPP (Expanded Polypropylene)
- suitable for VAROBOXX 3



Article No.	Article Description	QTY
9004 3 8	THERMO INSERT VAROBOXX3	1

Part.Panel, long f. Thermo Insert **VAROBOXX 3+4**

- measurements (WxH): 140x 355 mm
- for subdivision of thermo insert
- suitable for VAROBOXX 3 and 4



Article No.	Article Description	QTY
9004 3 9	PART.PAN.THERM.LO.VAROBOXX3+4	1

Silicone Cartridge Insert **VAROBOXX 3+4**

- measurements (LxWxH): 295 × 190 × 95 mm
- 1 use for 13 silicone cartridges
- 2 inserts fit in the VAROBOXX
- can be combined with a foam cartridge insert
- suitable for VAROBOXX 3 and 4



Article No.	Article Description	QTY
9004 4 13	SILICONE CARTR.INSERTVAROBOXX4	1

Foam Cartridge Insert **VAROBOXX 3+4**

- measurements (LxWxH): 295 × 190 × 95 mm
- 1 insert for 7 foam cartridges
- 2 inserts fit in the VAROBOXX
- can be combined with a silicone cartridge insert
- suitable for VAROBOXX 3 and 4



Article No.	Article Description	QTY
9004 4 7	FOAM CARTRIDGE INSERTVAROBOXX4	1

Mounting Roll Insert **VAROBOXX 4**

- 2 metal inserts, including fixing set and mounting instructions for transporting suspension files in the VAROBOXX
- suitable for VAROBOXX 4



Article No.	Article Description	QTY
9004 4 9	MOUNT.ROLL INSERT VAROBOXX4	1

Anti-slip Mat **VAROBOXX 4**

- Dimension (W x D x H): 381 x 291 x 4 mm
- Soft rubber insert
- Protects the VAROBOXX and the material against transport damages
- Suitable for VAROBOXX 4



Article No.	Article Description	QTY
9005 4 1	ANTI-SKID MAT VAROBOX 4	1

Thermo Insert **VAROBOXX 4**

- measurements (LxWxH): 326 x 239 x 290 mm
- thermo insert for storing and transporting temperature-sensitive materials such as comribands and other construction chemicals
- at a starting temperature of 20°C and an ambient temperature of -10° the internal temperature of the filled VAROBOXX does not fall below 0°C for 10 hours
- thermo inlay consists of insulating EPP (Expanded Polypropylene)
- suitable for VAROBOXX 4



Article No.	Article Description	QTY
9004 4 1	THERMO INSERT VAROBOXX4	1

Slot Pass Partition Plate, short **VAROBOXX 4**

- measurements (WxH): 283 x255 mm
- for individual classification of the pass partition plate framework
- Supplied with 4 clips
- suitable for VAROBOXX 4

Article No.	Article Description	QTY
9004 4 2	SLO.PART.PLATE SHORT VAROBOXX4	1



Slot Pass Partition Plate, long **VAROBOXX 4**

- measurements (WxH): 354 x255 mm
- for individual classification of the pass partition plate framework
- Supplied with 4 clips
- suitable for VAROBOXX 4

Article No.	Article Description	QTY
9004 4 3	SLOT.PART.PLATE LONG VAROBOXX4	1

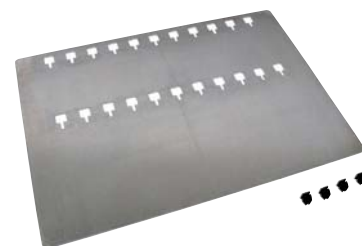

Pass Partition Plate, short **VAROBOXX 4**

- measurements (WxH): 137 x 255 mm
- for individual classification of the pass partition plate framework
- Supplied with 4 clips
- suitable for VAROBOXX 4

Article No.	Article Description	QTY
9004 4 4	PART.PLATE SHORT VAROBOXX4	1



Pass Partition Plate, long **VAROBOXX 4**

- measurements (WxH): 173 x255 mm
- for individual division of the partition panel frame
- Supplied with 4 clips
- suitable for VAROBOXX 4

Article No.	Article Description	QTY
9004 4 5	PART.PLATE LONG VAROBOXX 4	1



Electricians' Tool Holder

- for VAROBOXX 4
- useful arrangement of electricians' tools
- direct access to all tools
- perfect storage and ordering
- with bottom compartment for inset boxes

Article No.	Article Description	QTY
9004 4 10	ELECTR.TOOL HOLDER VAROBOXX4	1

(delivery without contents)

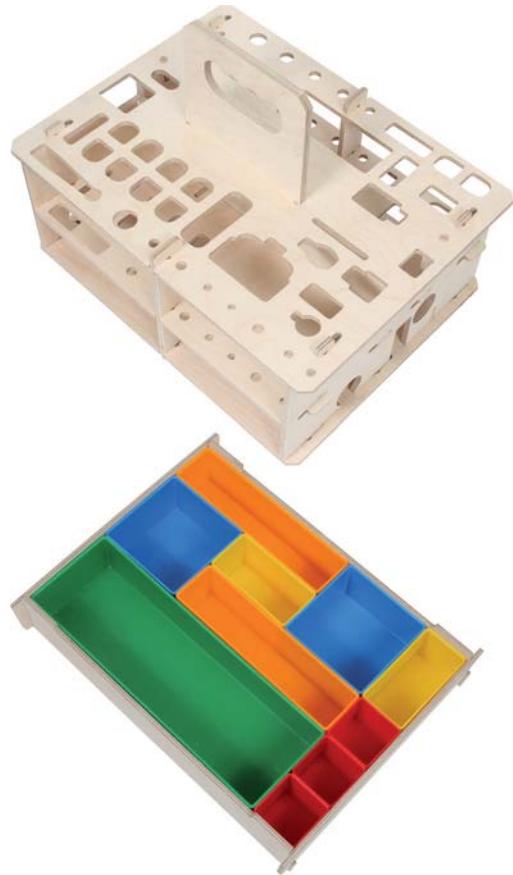

Joiners' Tool Holder

- for VAROBOXX 4
- useful arrangement of joiners' tools
- direct access to all tools
- perfect storage and ordering
- with bottom compartment for inset boxes

Article No.	Article Description	QTY
9004 4 11	JOINERS'S TOOL HOLD.VAROBOXX4	1

(delivery without contents)

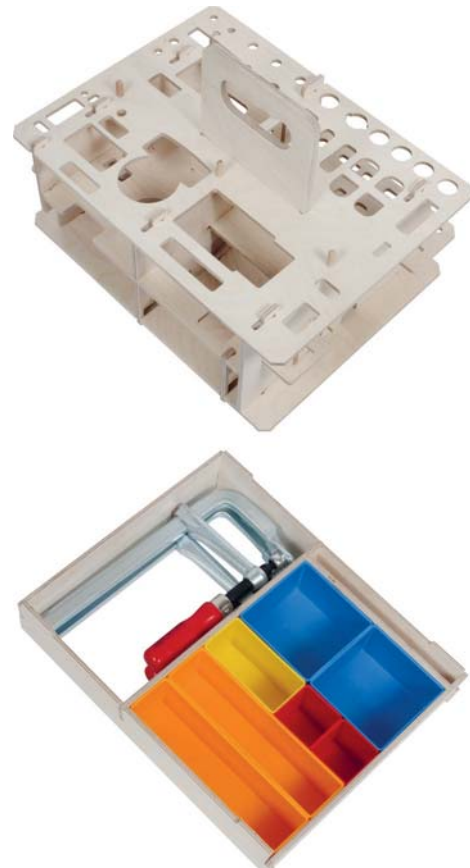

Tool Kit for Electrician's Carry Set

Contents

Article No.	Article Description	Quantity
3790 4	MULTICORE CABLE END PLIERS 143	1
3790 31	AUTOMATIC WIRE STRIPPER/CUTTER	1
3790 50	CABLE JACKET REMOVER NO.15	1
3790 53	ELECTR.CABLE KNIFE NO.28H	1
3791 6 690	VOLTAGE TESTER DIGITAL AC	1
4002 185	COMBINATION PLIERS 185MM	1
4012 160	SIDE CUTTER 160MM	1
4032 200	LONGNOSEPLIE.STRAIGHT200MM	1
4072 160	CABLE STRIPPER 160MM	1
4072 210 5	CABLE CUTTER 210 5*	1
4256 6	A-HEX. SCREWDRIVER MC SW 6	1
4256 7	A-HEX. SCREWDRIVER MC SW 7	1
4256 8	A-HEX. SCREWDRIVER MC SW 8	1
4256 10	A-HEX. SCREWDRIVER MC SW 10	1
4256 13	A-HEX. SCREWDRIVER MC SW 13	1
4260 25	VDE-SCREWDRIVER MK 2.5	1
4260 4	VDE-SCREWDRIVER MC 4	1
4260 55	SCREWDRIVER MC 5.5	1
4260 65	SCREWDRIVER MC 6.5	1
4261 1	VDE-PH SCREWDRIVER MK 1	1
4261 2	VDE-PH SCREWDRIVER MC 2	1
4264 31	VOLT.TESTER GS 3MM	1
4290 1	HOLE PUNCH	1
4319 9	1/4"BI-SAFE+HOLD.RAT.31PCS.5*	1
4379 9	SCREWDRIVER BIT SET 8PCS.5*	1
4650 250	KNIP.COBRA WAPO.PLIERS250MM 5*	1
4700 3	ELEC.SPLI.CHIS.W.H.PR.27X250MM	1
4701 25	FLAT CHISEL DIN 6453 25X200MM	1
4711 10	ELECTRICIAN'S CHISEL 10X200MM	1
4713 6 30	CHALK LINE MARKER PP 30M	1
4713 120	CHALK PEN-HOLDER 12,0MM	1
4717 22 50	ELECTR.SPIRIT LEVEL 22CM	1
4720 5 300	ENGINEER HAMMER DIN 300G 5*	1
4722 5 1000	CLUB HAMMER 1000G 5*	1
4740 200 2	FILE FLAT-HAND 200MM CUT 2	1
4741 200 2	FILE TRIANGULAR 200MM CUT 2	1
4742 200 2	FILE SQUARE 200MM CUT 2	1
4743 200 2	FILE HALF-ROUND 200MM CUT 2	1
4744 200 2	FILE ROUND 200MM CUT 2	1
4762 6	FÖRCH KNIFE 18MM RETR.BLADE	1
5422 60	STAINLESS STEEL SPATULA 60MM	1
5509 5500	TWIST DR. BOX RF1.0-10.0 19PCS	1
5701 145 2	JUNIOR HACKSAW	1
9894 32	'FÖRCH'FOLDING METRE STICK 2M	1



Article No.	Article Description	QTY
4998 9003 4 1	TOOL..RANGE CARRY SET ELECTR.	1

Tool Kit for Carpenter's Carry Set

Contents

Article No.	Article Description	Quantity
4000 160	COMBINATION PLIERS 160MM	1
4010 160	SIDE CUTTER 160MM 5*	1
4159 20	HEX-PLUS BP ALLEN KEY SET 9-PA	1
4200 35	MC-SCREWDRIV.PASS.BL. 3.5 5*	1
4200 45	MC-SCREWDRIV.PASS.BL.4.5 5*	1
4200 55	MC-SCREWDRIV.PASS.BL.5.5 5*	1
4201 1	MC SCREWDR.PH 1 PASS BLADE 5*	1
4201 2	MC SCREWDR.PH 2 PASS BLADE 5*	1
4319 9	1/4"BI-SAFE+HOLD.RAT.31PCS.5*	1
4379 9	SCREWDRIVER BIT SET 8PCS. 5*	1
4650 250	KNIP-COBRA WAPO.PLIERS250MM 5*	1
4680 200	PINCERS 200MM	1
4692 200	ALL-STEEL SCREW CLAMP 200X100	1
4701 25	FLAT CHISEL DIN 6453 25X200MM	1
4704 10	CENTRE PUNCH DIN 7250 120X10MM	1
4706 150	NEEDLE-POINT COM.150MM DIN6486	1
4717 40	LM-PRECISION-SPIRIT LEVEL 40CM	1
4721 22	CABINETMAKER'S HA.FRENCH 22MM	1
4740 250 2	FILE FLAT-HAND 250MM CUT 2	1
4760 9	COMBI-HOSE SHEARS 190MM	1
4762 6	FÖRCH KNIFE 18MM RETR.BLADE	1
4773 220	HAND PLANE RALI 220	1
4774 0 150	MORTISE GAUGE BEECH 0-150MM	1
4774 250	TRY SQUARES/MITRE ROSEWO.250MM	1
4774 250 4	MITRE GAUGE ROSEWOOD 250MM	1
4774 300 2	SLIDING BEVEL/PALI. 300MM	1
4780 10	CHISEL 5139B 10MM	1
4780 12	CHISEL 5139B 12MM	1
4780 16	CHISEL 5139B 16MM	1
4780 20	CHISEL 5139B 20MM	1
4780 26	CHISEL 5139B 26MM	1
5509 5504	BULLET DRILL SET 1-10 19PIECES	1
5670 15	FORSTNER BIT 15	1
5670 25	FORSTNER BIT 25	1
5701 145 2	JUNIOR HACKSAW	1
5704 16 265	PRECISION SAW CARPENTER 265MM	1
5924 2	GRIND.BLOCK - CORK 120X60X35MM	1
6850 3 05	WOOD-COLD-GLUE D3/D4 0.5KG	1
8680 20	BITTING GAUGE UNIVERSAL	1
9894 29	'FÖRCH' PENCIL	1
9894 30	'FÖRCH' CARPENTER'S PENCIL	1
9894 32	'FÖRCH'FOLDING METRE STICK 2M	1

Article No.	Article Description	QTY
4998 9003 4	TOOL.RANGE CARRY SET CARPENTER	1



Hexagon Head Screw 8.8 M5/M6, GA **VAROBOXX**

- Assortment in VAROBOXX 1
- Contents: DIN 933, 934, 125, 127
- Fully threaded
- Strength class 8.8
- **Galvanised steel**

Contents

Article No.	Article Description	Quantity
1011 5 30	HEX HD SCR. 933 8.8 GA 5X 30	150
1011 5 50	HEX HD SCR. 933 8.8 GA 5X 50	100
1011 5 70	HEX HD SCR. 933 8.8 GA 5X 70	50
1011 6 30	HEX HD SCR. 933 8.8 GA 6X 30	150
1011 6 50	HEX HD SCR. 933 8.8 GA 6X 50	50
1011 6 80	HEX HD SCR. 933 8.8 GA 6X 80	50
2001 5	HEX NUT 934-8 GA 5	100
2001 6	HEX NUT 934-8 GA 6	100
2301 5	WASHER 125 A GA 5	200
2301 6	WASHER 125 A GA 6	200
2331 5 12	PANEL REP WASHER GA 5X12	200
2331 6 18	PANEL REP WASHER GA 6X18	200
2501 5	SPRING WASHER 127 GA 5	200
2501 6	SPRING WASHER 127 GA 6	200
9003 1	VAROBOXX SIZE:1 EMPTY	1
9004 0 1	COVER INLAY VAROBOXX	1
9004 1 0	INSET BOX GREY SIDE.VAROBOXX 1	2
9004 1 0 1	DIVI.INSET BOX SIZE VAROBOXX 1	4
9004 1 5 10	INS.BOX YELL.5X10CM VAROBOXX 1	3
9004 1 10 10	INS.BOX BLUE10X10CM VAROBOXX 1	6



Article No.	Article Description	QTY
9003 1011 1	VAROBOXX HEX-SCREW M5/M6 GALV.	1

Hexagon Head Screw 8.8, M8/M10, GA **VAROBOXX**

- Assortment in VAROBOXX 1
- Contents: DIN 933, 934, 125, 127
- Fully threaded
- Strength class 8.8
- **Galvanised steel**

Contents

Article No.	Article Description	Quantity
1011 8 30	HEX HD M.SCREW933 8.8 GA 8X 30	50
1011 8 50	HEX HD M.SCREW933 8.8 GA 8X 50	50
1011 8 80	HEX HD SCR. 933 8.8 GA 8X 80	25
1011 10 30	HEX HD M.SCREW933 8.8 GA 10X30	50
1011 10 50	HEX HD M.SCREW933 8.8 GA 10X50	25
1011 10 80	HEX HD SCR. 933 8.8 GA 10X 80	25
2001 8	HEX NUT 934-8 GA 8	100
2001 10	HEX NUT 934-8 GA 10	100
2301 8	WASHER 125 A GA 8	200
2301 10	WASHER 125 A GA 10	200
2331 8 20	PANEL REP WASHER GA 8X20	200
2331 10 20	PANEL REP WASHER GA 10X20	200
2501 8	SPRING WASHER 127 GA 8	200
2501 10	SPRING WASHER 127 GA 10	200
9003 1	VAROBOXX SIZE:1 EMPTY	1
9004 0 1	COVER INLAY VAROBOXX	1
9004 1 0	INSET BOX GREY SIDE.VAROBOXX 1	2
9004 1 0 1	DIVI.INSET BOX SIZE VAROBOXX 1	4
9004 1 5 10	INS.BOX YELL.5X10CM VAROBOXX 1	3
9004 1 10 10	INS.BOX BLUE10X10CM VAROBOXX 1	6



Article No.	Article Description	QTY
9003 1011	VAROBOXX HEX-SCREW M8/10 GALV.	1

Oval Head Screw 4.8 M4-M6, GA **VAROBOXX**

- Assortment in VAROBOXX 1
- Contents: DIN 7985, 934, 125
- Corresponds to ISO 7045
- Drive: PZ
- Strength class 4.8
- **Galvanised steel**

Contents

Article No.	Article Description	Quantity
1231 4 16	OVAL HD SCREW 7985 GA 4X 16	200
1231 4 20	OVAL HD SCREW 7985 GA 4X 20	200
1231 4 30	OVAL HD SCREW 7985 GA 4X 30	100
1231 5 16	OVAL HD SCREW 7985 GA 5X 16	200
1231 5 20	OVAL HD SCREW 7985 GA 5X 20	200
1231 5 30	OVAL HD SCREW 7985 GA 5X 30	100
1231 6 16	OVAL HD SCREW 7985 GA 6X 16	200
1231 6 20	OVAL HD SCREW 7985 GA 6X 20	200
1231 6 30	OVAL HD SCREW 7985 GA 6X 30	100
2001 4	HEX NUT 934-8 GA 4	500
2001 5	HEX NUT 934-8 GA 5	500
2001 6	HEX NUT 934-8 GA 6	500
2301 4	WASHER 125 A GA 4	500
2301 5	WASHER 125 A GA 5	500
2301 6	WASHER 125 A GA 6	500
9003 1	VAROBOXX SIZE:1 EMPTY	1
9004 0 1	COVER INLAY VAROBOXX	1
9004 1 0	INSET BOX GREY SIDE.VAROBOXX 1	2
9004 1 0 1	DIVI.INSET BOX SIZE VAROBOXX 1	4
9004 1 5 10	INS.BOX YELL.5X10CM VAROBOXX 1	3
9004 1 10 10	INS.BOX BLUE10X10CM VAROBOXX 1	6



Article No.	Article Description	QTY
9003 1231	VAROBOXX OVAL HEAD SCREW M4-M6	1

Oval Head Screw 7985 4.8 M3-M8, GA **VAROBOXX**

- Assortment in VAROBOXX 1
- Contents: DIN 7985
- Corresponds to ISO 7045
- Drive: PZ
- Strength class 4.8
- **Galvanised steel**

Contents

Article No.	Article Description	Quantity
1231 3 20	OVAL HEAD SCREW 7985 GA 3X 20	300
1231 4 10	OVAL HEAD SCREW 7985 GA 4X 10	300
1231 4 16	OVAL HD SCREW 7985 GA 4X 16	200
1231 4 20	OVAL HD SCREW 7985 GA 4X 20	150
1231 4 30	OVAL HD SCREW 7985 GA 4X 30	100
1231 4 40	OVAL HEAD SCREW 7985 GA 4X 40	100
1231 4 50	OVAL HEAD SCREW 7985 GA 4X 50	100
1231 5 16	OVAL HD SCREW 7985 GA 5X 16	100
1231 5 20	OVAL HD SCREW 7985 GA 5X 20	100
1231 5 30	OVAL HD SCREW 7985 GA 5X 30	100
1231 5 40	OVAL HEAD SCREW 7985 GA 5X 40	50
1231 5 50	OVAL HEAD SCREW 7985 GA 5X 50	50
1231 6 16	OVAL HD SCREW 7985 GA 6X 16	100
1231 6 20	OVAL HD SCREW 7985 GA 6X 20	100
1231 6 30	OVAL HD SCREW 7985 GA 6X 30	100
1231 6 40	OVAL HEAD SCREW 7985 GA 6X 40	100
1231 6 50	OVAL HEAD SCREW 7985 GA 6X 50	50
1231 8 20	OVAL HEAD SCREW 7985 GA 8X 20	100
9003 1	VAROBOXX SIZE:1 EMPTY	1
9004 0 1	COVER INLAY VAROBOXX	1
9004 1 0	INSET BOX GREY SIDE.VAROBOXX 1	2
9004 1 0 1	DIVI.INSET BOX SIZE VAROBOXX 1	4
9004 1 5 10	INS.BOX YELL.5X10CM VAROBOXX 1	9
9004 1 10 10	INS.BOX BLUE10X10CM VAROBOXX 1	3



Article No.	Article Description	QTY
9003 1231 1	VAROBOX CSK-PH-SCREW M3-M8 GA	1

Washers, GA VAROBOXX

- Assortment in VAROBOXX 1
- Contents: DIN 125 Shape A, corresponds to ISO 7099/Shape B, corresponds to ISO 7089
- Galvanised steel

Contents

Article No.	Article Description	Quantity
2301 4	WASHER 125 A GA 4	1000
2301 5	WASHER 125 A GA 5	1000
2301 6	WASHER 125 A GA 6	500
2301 8	WASHER 125 A GA 8	300
2301 10	WASHER 125 A GA 10	100
2301 12	WASHER 125 A GA 12	100
2303 4	WASHER DIN 125 B GA 4	1000
2303 5	WASHER DIN 125 B GA 5	1000
2303 6	WASHER DIN 125 B GA 6	1000
2303 8	WASHER DIN 125 B GA 8	500
2303 10	WASHER DIN 125 B GA 10	300
2303 12	WASHER DIN 125 B GA 12	100
9003 1	VAROBOXX SIZE:1 EMPTY	1
9004 0 1	COVER INLAY VAROBOXX	1
9004 1 0	INSET BOX GREY SIDE.VAROBOXX 1	2
9004 1 0 1	DIVI.INSET BOX SIZE VAROBOXX 1	2
9004 1 5 10	INS.BOX YELL.5X10CM VAROBOXX 1	1
9004 1 5 20	INS.BOX ORAN.5X20CM VAROBOXX 1	1
9004 1 10 10	INS.BOX BLUE10X10CM VAROBOXX 1	6



Article No.	Article Description	QTY
9003 2301 2303	VAROBOXX WASHER 125 SHAPE:A/B	1

Nuts/Washers, GA VAROBOXX

- Assortment in VAROBOXX 1
- Contents: DIN 934-8, corresponds to ISO 4032/DIN 125, corresponds to ISO 7089
- Strength class 8
- Galvanised steel

Contents

Article No.	Article Description	Quantity
2001 5	HEX NUT 934-8 GA 5	900
2001 6	HEX NUT 934-8 GA 6	600
2001 8	HEX NUT 934-8 GA 8	300
2001 10	HEX NUT 934-8 GA 10	200
2001 12	HEX NUT 934-8 GA 12	100
2301 5	WASHER 125 A GA 5	900
2301 6	WASHER 125 A GA 6	600
2301 8	WASHER 125 A GA 8	300
2301 10	WASHER 125 A GA 10	200
2301 12	WASHER 125 A GA 12	100
9003 1	VAROBOXX SIZE:1 EMPTY	1
9004 0 1	COVER INLAY VAROBOXX	1
9004 1 0	INSET BOX GREY SIDE.VAROBOXX 1	2
9004 1 0 1	DIVI.INSET BOX SIZE VAROBOXX 1	3
9004 1 10 15	INSETB.L-GR.10X15CM VAROBOXX 1	5



Article No.	Article Description	QTY
9003 2001 2301	VAROBOXX NUT/WASH.DIN125/934-8	1

Self-Tapping Screw, GA **VAROBOXX**

- Assortment in VAROBOXX 1
- Contents: DIN 7981 C
- Corresponds to ISO 7049
- Drive: PH
- Case-hardened
- **Galvanised steel**

Contents

Article No.	Article Description	Quantity
1311 29 95	SELF-TAP.SCREW 7981 GA 2.9X9.5	800
1311 35 65	SELF-TAP.SCREW 7981 GA 3.5X6.5	600
1311 35 95	SELF-TAP.SCREW 7981 GA 3.5X9.5	500
1311 35 13	SELF-TAP.SCREW 7981 GA 3.5X 13	300
1311 35 16	SELF-TAP.SCREW 7981 GA 3.5X 16	300
1311 35 19	SELF-TAP.SCREW 7981 GA 3.5X 19	300
1311 35 22	SELF-TAP.SCREW 7981 GA 3.5X 22	300
1311 39 95	SELF-TAP.SCREW 7981 GA 3.9X9.5	400
1311 39 13	SELF-TAP.SCREW 7981 GA 3.9X 13	300
1311 39 16	SELF-TAP.SCREW 7981 GA 3.9X 16	500
1311 39 22	SELF-TAP.SCREW 7981 GA 3.9X 22	400
1311 39 25	SELF-TAP.SCREW 7981 GA 3.9X 25	400
1311 42 95	SELF-TAP.SCREW 7981 GA 4.2X9.5	300
1311 42 13	SELF-TAP.SCREW 7981 GA 4.2X 13	300
1311 42 16	SELF-TAP.SCREW 7981 GA 4.2X 16	200
1311 42 19	SELF-TAP.SCREW 7981 GA 4.2X 19	200
1311 42 22	SELF-TAP.SCREW 7981 GA 4.2X 22	200
1311 42 25	SELF-TAP.SCREW 7981 GA 4.2X 25	200
9003 1	VAROBOXX SIZE:1 EMPTY	1
9004 0 1	COVER INLAY VAROBOXX	1
9004 1 0	INSET BOX GREY SIDE.VAROBOXX 1	2
9004 1 0 1	DIVI.INSET BOX SIZE VAROBOXX 1	4
9004 1 5 10	INS.BOX YELL.5X10CM VAROBOXX 1	9
9004 1 10 10	INS.BOX BLUE10X10CM VAROBOXX 1	3



Article No.	Article Description	QTY
9003 1311	VAROBOXX SELF-TAPP.SCR.7981 GA	1

Self-Drilling Screw Panhead, GA **VAROBOXX**

- Assortment in VAROBOXX 1
- Contents: DIN 7504 M
- Drive: PH
- Galvanised steel

Contents

Article No.	Article Description	Quantity
1351 35 95	PAN HD SD SCR. 7504M GA3.5X9.5	300
1351 35 13	PAN HD SD SCR. 7504M GA 3.5X13	300
1351 35 16	PAN HD SD SCR. 7504M GA 3.5X16	200
1351 39 13	PAN HD SD SCR. 7504M GA 3.9X13	150
1351 39 16	PAN HD SD SCR. 7504M GA 3.9X16	100
1351 39 19	PAN HD SD SCR. 7504M GA 3.9X19	100
1351 39 25	PAN HD SD SCR. 7504M GA 3.9X25	100
1351 42 13	PAN HD SD SCR. 7504M GA 4.2X13	100
1351 42 16	PAN HD SD SCR. 7504M GA 4.2X16	100
1351 42 19	PAN HD SD SCR. 7504M GA 4.2X19	200
1351 42 22	PAN HD SD SCR. 7504M GA 4.2X22	200
1351 42 25	PAN HD SD SCR. 7504M GA 4.2X25	200
1351 48 16	PAN HD SD SCR. 7504M GA 4.8X16	100
1351 48 19	PAN HD SD SCR. 7504M GA 4.8X19	100
1351 48 22	PAN HD SD SCR. 7504M GA 4.8X22	100
1351 48 25	PAN HD SD SCR. 7504M GA 4.8X25	100
1351 48 32	PAN HD SD SCR. 7504M GA 4.8X32	50
1351 48 38	PAN HD SD SCR. 7504M GA 4.8X38	100
9003 1	VAROBOXX SIZE:1 EMPTY	1
9004 0 1	COVER INLAY VAROBOXX	1
9004 1 0	INSET BOX GREY SIDE VAROBOXX 1	2
9004 1 0 1	DIVI.INSET BOX SIZE VAROBOXX 1	4
9004 1 5 10	INS.BOX YELL.5X10CM VAROBOXX 1	9
9004 1 10 10	INS.BOX BLUE10X10CM VAROBOXX 1	3



Article No.	Article Description	QTY
9003 1351	VAROBOXX CSK-PH-DRILL.SCREW GA	1

Blind Rivet with Flat Head **VAROBOXX**

- Assortment in VAROBOXX 1
- Rivet sleeve: aluminium
- Rivet mandrel: galvanised steel

Contents

Article No.	Article Description	Quantity
2710 3 4	BLIND RIV.TRUSS-HD AL/ST 3X4	100
2710 3 6	BLIND RIV.TRUSS-HD AL/ST 3X6	200
2710 3 8	BLIND RIV.TRUSS-HD AL/ST 3X8	100
2710 3 10	BLIND RIV.TRUSS-HD AL/ST 3X10	100
2710 3 12	BLIND RIV.TRUSS-HD AL/ST 3X12	100
2710 4 6	BLIND RIV.TRUSS-HD AL/ST 4X6	100
2710 4 8	BLIND RIV.TRUSS-HD AL/ST 4X8	100
2710 4 10	BLIND RIV.TRUSS-HD AL/ST 4X10	100
2710 4 12	BLIND RIV.TRUSS-HD AL/ST 4X12	100
2710 4 16	BLIND RIV.TRUSS-HD AL/ST 4X16	100
2710 5 8	BLIND RIV.TRUSS-HD AL/ST 5X8	100
2710 5 10	BLIND RIV.TRUSS-HD AL/ST 5X10	100
2710 5 12	BLIND RIV.TRUSS-HD AL/ST 5X12	100
2710 5 16	BLIND RIV.TRUSS-HD AL/ST 5X16	100
2710 5 18	BLIND RIV.TRUSS-HD AL/ST 5X18	100
2722 1	HAND RIVET GUN MFX150B	1
9003 1	VAROBOXX SIZE:1 EMPTY	1
9004 0 1	COVER INLAY VAROBOXX	1
9004 1 0	INSET BOX GREY SIDE.VAROBOXX 1	2
9004 1 0 1	DIVI.INSET BOX SIZE VAROBOXX 1	4
9004 1 5 10	INS.BOX YELL.5X10CM VAROBOXX 1	9
9004 1 10 30	INSETB.D-GR.10X30CM VAROBOXX 1	1



Article No.	Article Description	QTY
9003 2710	VAROBOXX FHD-BLIND RIVET AL/ST	1

Wood Screws 4/4.5 TX, Ribbed GA **VAROBOXX**

- Assortment in VAROBOXX 1
- Partly thread
- Wood screws are especially suitable for solid wood
- Yellow galvanised steel

Contents

Article No.	Article Description	Quantity
1628 4 20	FSK-TX20 WOSCR.FT YELLOW 4X 20	250
1628 4 25	FSK-TX20 WOSCR.FT YELLOW 4X 25	200
1628 4 30	FSK-TX20 WOSCR.PT YELLOW 4X 30	200
1628 4 35	FSK-TX20 WOSCR.PT YELLOW 4X 35	125
1628 4 40	FSK-TX20 WOSCR.PT YELLOW 4X 40	250
1628 4 45	FSK-TX20 WOSCR.PT YELLOW 4X 45	125
1628 4 50	FSK-TX20 WOSCR.PT YELLOW 4X 50	125
1628 4 60	FSK-TX20 WOSCR.PT YELLOW 4X 60	200
1628 45 45	FSK-TX25 WOSCR.PT YELLOW4.5X45	200
1628 45 50	FSK-TX25 WOSCR.PT YELLOW4.5X50	200
1628 45 60	FSK-TX25 WOSCR.PT YELLOW4.5X60	100
1628 45 70	FSK-TX25 WOSCR.PT YELLOW4.5X70	100
1628 45 80	FSK-TX25 WOSCR.PT YELLOW4.5X80	100
4303 20	1/4"TX-BITS 25MM TX 20	10
4303 25	1/4"TX-BITS 25MM TX 25	10
9003 1	VAROBOXX SIZE:1 EMPTY	1
9004 0 1	COVER INLAY VAROBOXX	1
9004 1 0	INSET BOX GREY SIDE.VAROBOXX 1	2
9004 1 0 1	DIVI.INSET BOX SIZE VAROBOXX 1	5
9004 1 5 10	INS.BOX YELL.5X10CM VAROBOXX 1	3
9004 1 10 10	INS.BOX BLUE10X10CM VAROBOXX 1	6



Article No.	Article Description	QTY
9003 1628 1	VAROBOXX WOODSCR.TX 4/4.5MM GA	1

Wood Screws 5/6 TX Ribbed, GA **VAROBOXX**

- Assortment in VAROBOXX 1
- Partly thread
- Wood screws are especially suitable for sold wood
- Drive: TX
- **Yellow galvanised steel**

Contents

Article No.	Article Description	Quantity
1628 5 50	FSK-TX25 WOSCR.PT YELLOW 5X 50	100
1628 5 60	FSK-TX25 WOSCR.PT YELLOW 5X 60	100
1628 5 70	FSK-TX25 WOSCR.PT YELLOW 5X 70	50
1628 5 80	FSK-TX25 WOSCR.PT YELLOW 5X 80	50
1628 5 90	FSK-TX25 WOSCR.PT YELLOW 5X 90	100
1628 5 100	FSK-TX25 WOSCR.PT YELLOW 5X100	100
1628 6 60	FSK-TX25 WOSCR.PT YELLOW 6X 60	50
1628 6 70	FSK-TX25 WOSCR.PT YELLOW 6X 70	100
1628 6 80	FSK-TX25 WOSCR.PT YELLOW 6X 80	100
1628 6 90	FSK-TX25 WOSCR.PT YELLOW 6X 90	100
1628 6 100	FSK-TX25 WOSCR.PT YELLOW 6X100	100
4303 25	1/4"TX-BITS 25MM TX 25	10
9003 1	VAROBOXX SIZE:1 EMPTY	1
9004 0 1	COVER INLAY VAROBOXX	1
9004 1 0	INSET BOX GREY SIDE.VAROBOXX 1	2
9004 1 0 1	DIVI.INSET BOX SIZE VAROBOXX 1	5
9004 1 10 10	INS.BOX BLUE10X10CM VAROBOXX 1	3
9004 1 10 15	INSETB.L-GR.10X15CM VAROBOXX 1	3



Article No.	Article Description	QTY
9003 1628	VAROBOXX WOODSCR.TX 5/6MM GA	1

Woodscrews 4 / 5 TX SK Milled Ribs, GA **VAROBOXX**

- Assortment in VAROBOXX 1
- Part thread
- Construction woodscrews have been developed specially for use in solid timber
- Drive: TX
- **Zinc-plated steel**

Contents

Article No.	Article Description	Quantity
1629 4 40	FSK-TX20 WOODSCR.PT GA 4X40	125
1629 4 50	FSK-TX20 WOODSCR.PT GA 4X50	100
1629 4 60	FSK-TX20 WOODSCR.PT GA 4X60	100
1629 45 35	FSK-TX25 WOODSCR.PT GA 4.5X35	50
1629 45 50	FSK-TX25 WOODSCR.PT GA 4.5X50	100
1629 45 70	FSK-TX25 WOODSCR.PT GA 4.5X70	75
1629 5 40	FSK-TX25 WOODSCR.PT GA 5X40	100
1629 5 45	FSK-TX25 WOODSCR.PT GA 5X45	100
1629 5 50	FSK-TX25 WOODSCR.PT GA 5X50	150
1629 5 60	FSK-TX25 WOODSCR.PT GA 5X60	100
1629 5 70	FSK-TX25 WOODSCR.PT GA 5X70	100
1629 5 80	FSK-TX25 WOODSCR.PT GA 5X80	100
1629 5 90	FSK-TX25 WOODSCR.PT GA 5X90	100
1629 5 100	FSK-TX25 WOODSCR.PT GA 5X100	100
4303 25	1/4"TX-BITS 25MM TX 25	10
9003 1	VAROBOXX SIZE:1 EMPTY	1
9004 0 1	COVER INLAY VAROBOXX	1
9004 1 0	INSET BOX GREY SIDE.VAROBOXX 1	2
9004 1 0 1	DIVI.INSET BOX SIZE VAROBOXX 1	5
9004 1 5 10	INS.BOX YELL.5X10CM VAROBOXX 1	2
9004 1 10 10	INS.BOX BLUE10X10CM VAROBOXX 1	5
9004 1 10 15	INSETB.L-GR.10X15CM VAROBOXX 1	1



Article No.	Article Description	QTY
9003 1629	VAROBOXX CSH-TX WOODSCR. 4-5MM	1

Woodscrews 3.5 / 4 TX SK Milled Ribs, GA **VAROBOXX**

- Assortment in VAROBOXX 1
- Part thread
- Construction woodscrews have been developed specially for use in solid timber
- Drive: TX
- **Zinc-plated steel**

Contents

Article No.	Article Description	Quantity
1629 35 12	FSK-TX20 WOODSCR.FT GA 3.5X12	500
1629 35 16	FSK-TX20 WOODSCR.FT GA 3.5X16	500
1629 35 20	FSK-TX20 WOODSCR.FT GA 3.5X20	500
1629 35 35	FSK-TX20 WOODSCR.PT GA 3.5X35	250
1629 35 40	FSK-TX20 WOODSCR.PT GA 3.5X40	250
1629 35 45	FSK-TX20 WOODSCR.PT GA 3.5X45	250
1629 35 50	FSK-TX20 WOODSCR.PT GA 3.5X50	250
1629 4 20	FSK-TX20 WOODSCR.FT GA 4X20	250
1629 4 25	FSK-TX20 WOODSCR.FT GA 4X25	250
1629 4 30	FSK-TX20 WOODSCR.PT GA 4X30	250
1629 4 35	FSK-TX20 WOODSCR.PT GA 4X35	250
1629 4 40	FSK-TX20 WOODSCR.PT GA 4X40	250
1629 4 45	FSK-TX20 WOODSCR.PT GA 4X45	250
1629 4 50	FSK-TX20 WOODSCR.PT GA 4X50	125
4303 15	1/4"TX-BITS 25MM TX 15	10
4303 20	1/4"TX-BITS 25MM TX 20	10
9003 1	VAROBOXX SIZE:1 EMPTY	1
9004 0 1	COVER INLAY VAROBOXX	1
9004 1 0	INSET BOX GREY SIDE.VAROBOXX 1	2
9004 1 0 1	DIVI.INSET BOX SIZE VAROBOXX 1	5
9004 1 5 10	INS.BOX YELL.5X10CM VAROBOXX 1	3
9004 1 10 10	INS.BOX BLUE10X10CM VAROBOXX 1	6



Article No.	Article Description	QTY
9003 1629 1	VAROBOXX CSH-TX WOODSC.3.5-4MM	1

Chipboard Screw 3-4 PZ CSK-Head, GA **VAROBOXX**

- Assortment in VAROBOXX 1
- Drive: PZ
- **Galvanised steel**

Contents

Article No.	Article Description	Quantity
1601 3 20	CSK PZ1 CHIPBSCR. GA 3X 20	500
1601 3 25	CSK PZ1 CHIPBSCR. GA 3X 25	250
1601 3 30	CSK PZ1 CHIPBSCR. GA 3X 30	250
1601 35 16	CSK PZ2 CHIPBSCR. GA 3.5X 16	500
1601 35 20	CSK PZ2 CHIPBSCR. GA 3.5X 20	500
1601 35 25	CSK PZ2 CHIPBSCR. GA 3.5X 25	500
1601 35 30	CSK PZ2 CHIPBSCR. GA 3.5X 30	500
1601 35 35	CSK PZ2 CHIPBSCR. GA 3.5X 35	500
1601 4 17	CSK PZ2 CHIPBSCR. GA 4X 17	500
1601 4 20	CSK PZ2 CHIPBSCR. GA 4X 20	250
1601 4 25	CSK PZ2 CHIPBSCR. GA 4X 25	250
1601 4 30	CSK PZ2 CHIPBSCR. GA 4X 30	500
1601 4 35	CSK PZ2 CHIPBSCR. GA 4X 35	250
1601 4 40	CSK PZ2 CHIPBSCR. GA 4X 40	250
4302 1	1/4"PZ-BITS 25MM SIZE 1	10
4302 2	1/4"PZ-BITS 25MM SIZE 2	10
9003 1	VAROBOXX SIZE:1 EMPTY	1
9004 0 1	COVER INLAY VAROBOXX	1
9004 1 0	INSET BOX GREY SIDE.VAROBOXX 1	2
9004 1 0 1	DIVI.INSET BOX SIZE VAROBOXX 1	5
9004 1 5 10	INS.BOX YELL.5X10CM VAROBOXX 1	3
9004 1 10 10	INS.BOX BLUE10X10CM VAROBOXX 1	6



Article No.	Article Description	QTY
9003 1601 1	VAROBOXX CHIPB.CSK-PZ 3-4MM GA	1

Chipboard Screw 4-6 PZ CSK-Head, GA **VAROBOXX**

- Assortment in VAROBOXX 1
- Drive: PZ
- Galvanised steel

Contents

Article No.	Article Description	Quantity
1601 4 45	CSK PZ2 CHIPBSCR. GA 4X 45	125
1601 4 50	CSK PZ2 CHIPBSCR. GA 4X 50	100
1601 4 55	CSK PZ2 CHIPBSCR. GA 4X 55	80
1601 45 45	CSK PZ2 CHIPBSCR. GA 4.5X 45	100
1601 45 50	CSK PZ2 CHIPBSCR. GA 4.5X 50	100
1601 45 60	CSK PZ2 CHIPBSCR. GA 4.5X 60	50
1601 5 50	CSK PZ2 CHIPBSCR. ZP 5X 50	75
1601 5 60	CSK PZ2 CHIPBSCR. ZP 5X 60	100
1601 5 70	CSK PZ2 CHIPBSCR. GA 5X 70	100
1602 6 60	CSK PZ3 CHIPBSCR.PT GA 6X 60	100
1602 6 70	CSK PZ3 CHIPBSCR.PT GA 6X 70	80
1602 6 80	CSK PZ3 CHIPBSCR.PT GA 6X 80	50
1602 6 100	CSK PZ3 CHIPBSCR.PT GA 6X100	75
4302 2	1/4"PZ-BITS 25MM SIZE 2	10
4302 3	1/4"PZ-BITS 25MM SIZE 3	10
9003 1	VAROBOXX SIZE:1 EMPTY	1
9004 0 1	COVER INLAY VAROBOXX	1
9004 1 0	INSET BOX GREY SIDE.VAROBOXX 1	2
9004 1 0 1	DIVI.INSET BOX SIZE VAROBOXX 1	5
9004 1 5 10	INS.BOX YELL.5X10CM VAROBOXX 1	2
9004 1 10 10	INS.BOX BLUE10X10CM VAROBOXX 1	5
9004 1 10 15	INSETB.L-GR.10X15CM VAROBOXX 1	1



Article No.	Article Description	QTY
9003 1601	VAROBOXX CHIPB.CSK-PZ 4-6MM GA	1

Chipboard Screw TX CSK-Head, GA **VAROBOXX**

- Assortment in VAROBOXX 1
- Drive: TX
- Yellow galvanized steel

Contents

Article No.	Article Description	Quantity
1600 4 60	CSK TX15 CH.SCR.PT YGA 4X 60	100
1600 45 45	CSK TX25 CH.SCR.PT YGA 4.5X 45	100
1600 45 50	CSK TX25 CH.SCR.PT YGA 4.5X 50	100
1600 45 60	CSK TX25 CH.SCR.PT YGA 4.5X 60	80
1600 45 80	CSK TX25 CH.SCR.PT YGA 4.5X 80	50
1600 5 50	CSK TX25 CH.SCR.PT YCR 5X 50	75
1600 5 70	CSK TX25 CH.SCR.PT YGA 5X 70	50
1600 5 90	CSK TX25 CH.SCR.PT YGA 5X 90	50
1600 6 60	CSK TX25 CH.SCR.PT YGA 6X 60	50
1600 6 70	CSK TX25 CH.SCR.PT YGA 6X 70	50
1600 6 80	CSK TX25 CH.SCR.PT YGA 6X 80	50
1625 35 20	CSK TX15 CHI.SCR.FT YGA.3.5X20	500
1625 35 30	CSK TX15 CHI.SCR.FT YGA.3.5X30	250
1625 35 35	CSK TX15 CHI.SCR.FT YGA 3.5X35	250
1625 4 20	CSK TX15 CHI.SCR.FT YGA 4X20	500
1625 4 25	CSK TX15 CHI.SCR.FT YGA 4X25	250
1625 4 30	CSK TX15 CHI.SCR.FT YGA 4X30	250
1625 4 35	CSK TX15 CHI.SCR.FT YGA 4X35	125
1625 4 40	CSK TX15 CHI.SCR.FT YGA 4X40	125
1625 4 50	CSK TX15 CHI.SCR.FT YGA 4X50	100
4303 15	1/4"TX-BITS 25MM TX 15	10
4303 25	1/4"TX-BITS 25MM TX 25	10
9003 1	VAROBOXX SIZE:1 EMPTY	1
9004 0 1	COVER INLAY VAROBOXX	1
9004 1 0	INSET BOX GREY SIDE.VAROBOXX 1	2
9004 1 0 1	DIVI.INSET BOX SIZE VAROBOXX 1	5
9004 1 5 10	INS.BOX YELL.5X10CM VAROBOXX 1	15



Article No.	Article Description	QTY
9003 1600	VAROBOXX CHIPB.CSK-TX YELL.GA	1

Chipboard Screw TX CSK-Head PT, GA

VAROBOXX

- Assortment in VAROBOXX 1
- Drive: TX
- Galvanised steel

Contents

Article No.	Article Description	Quantity
1610 45 45	CSK-TX25 CHIPB.SCR.PT GA4.5X45	125
1610 45 50	CSK-TX25 CHIPB.SCR.PT GA4.5X50	100
1610 45 60	CSK-TX25 CHIPB.SCR.PT GA4.5X60	80
1610 45 80	CSK-TX25 CHIPB.SCR.PT GA4.5X80	100
1610 5 50	CSK-TX25 CHIPB.SCR.PT GA 5X 50	100
1610 5 70	CSK-TX25 CHIPB.SCR.PT GA 5X 70	50
1610 5 90	CSK-TX25 CHIPB.SCR.PT GA 5X 90	200
1610 5 100	CSK-TX25 CHIPB.SCR.PT GA 5X100	100
1610 6 60	CSK-TX25 CHIPB.SCR.PT GA 6X 60	50
1610 6 70	CSK-TX25 CHIPB.SCR.PT GA 6X 70	100
1610 6 80	CSK-TX25 CHIPB.SCR.PT GA 6X 80	100
1610 6 100	CSK-TX25 CHIPB.SCR.PT GA 6X100	100
4303 25	1/4"TX-BITS 25MM TX 25	10
9003 1	VAROBOXX SIZE:1 EMPTY	1
9004 0 1	COVER INLAY VAROBOXX	1
9004 1 0	INSET BOX GREY SIDE.VAROBOXX 1	2
9004 1 0 1	DIVI.INSET BOX SIZE VAROBOXX 1	5
9004 1 5 10	INS.BOX YELL.5X10CM VAROBOXX 1	2
9004 1 10 10	INS.BOX BLUE10X10CM VAROBOXX 1	2
9004 1 10 15	INSETB.L-GR.10X15CM VAROBOXX 1	3



Article No.	Article Description	QTY
9003 1610	VAROBOXX CHIP.SCR.CSK-TX PT GA	1

Chipboard Screw TX CSK-Head, FT, GA

VAROBOXX

- Assortment in VAROBOXX 1
- Drive: TX
- Galvanised steel

Contents

Article No.	Article Description	Quantity
1626 3 20	CSK-TX10 CHIPB.SCR.FT GA 3X20	500
1626 3 25	CSK-TX10 CHIPB.SCR.FT ZP 3X25	500
1626 3 30	CSK-TX10 CHIPB.SCR.FT GA 3X30	250
1626 3 35	CSK-TX10 CHIPB.SCR.FT ZP 3X35	250
1626 35 20	CSK-TX15 CHIPB.SCR.FT GA3.5X20	500
1626 35 30	CSK-TX15 CHIPB.SCR.FT GA3.5X30	250
1626 35 35	CSK-TX15 CHIPB.SCR.FT GA3.5X35	250
1626 35 40	CSK-TX15 CHIPB.SCR.FT GA3.5X40	400
1626 4 16	CSK-TX15 CHIPB.SCR.FT GA 4X16	250
1626 4 20	CSK-TX15 CHIPB.SCR.FT GA 4X20	250
1626 4 25	CSK-TX15 CHIPB.SCR.FT GA 4X25	250
1626 4 30	CSK-TX15 CHIPB.SCR.FT GA 4X30	500
1626 4 35	CSK-TX15 CHIPB.SCR.FT ZP 4X35	250
1626 4 40	CSK-TX15 CHIPB.SCR.FT GA 4X40	250
1626 4 45	CSK-TX15 CHIPB.SCR.FT ZP 4X45	100
1626 4 50	CSK-TX15 CHIPB.SCR.FT GA 4X50	100
4303 10	1/4"TX-BITS 25MM TX 10	10
4303 15	1/4"TX-BITS 25MM TX 15	10
9003 1	VAROBOXX SIZE:1 EMPTY	1
9004 0 1	COVER INLAY VAROBOXX	1
9004 1 0	INSET BOX GREY SIDE.VAROBOXX 1	2
9004 1 0 1	DIVI.INSET BOX SIZE VAROBOXX 1	5
9004 1 5 10	INS.BOX YELL.5X10CM VAROBOXX 1	7
9004 1 10 10	INS.BOX BLUE10X10CM VAROBOXX 1	4



Article No.	Article Description	QTY
9003 1626	VAROBOXX CHIP.CSK FULL-THR.GA	1

Chipboard Screw PZ Panhead, GA **VAROBOXX**

- Assortment in VAROBOXX 1
- Drive: PZ
- Galvanised steel

Contents

Article No.	Article Description	Quantity
1611 4 20	CHIB.SCRW.PAN-H.PZ2 GA 4X 20	125
1611 4 25	CHIB.SCRW.PAN-H.PZ2 GA 4X 25	250
1611 4 30	CHIB.SCRW.PAN-H.PZ2 GA 4X 30	200
1611 4 35	CHIB.SCRW.PAN-H.PZ2 GA 4X 35	125
1611 4 40	CHIB.SCRW.PAN-H.PZ2 GA 4X 40	100
1611 4 45	CHIB.SCRW.PAN-H.PZ2 GA 4X 45	100
1611 4 50	CHIB.SCRW.PAN-H.PZ2 GA 4X 50	100
1611 45 20	CHIB.SCRW.PAN-H.PZ2 GA 4.5X 20	250
1611 45 35	CHIB.SCRW.PAN-H.PZ2 GA 4.5X 35	125
1611 45 40	CHIPB.SCR.PAN-H.PZ2 GA 4.5X 40	100
1611 45 50	CHIB.SCRW.PAN-H.PZ2 GA 4.5X 50	80
1611 45 60	CHIB.SCRW.PAN-H.PZ2 GA 4.5X 60	50
1611 5 30	CHIB.SCRW.PAN-H.PZ2 GA 5X 30	125
1611 5 40	CHIB.SCRW.PAN-H.PZ2 GA 5X 40	100
1611 5 50	CHIB.SCRW.PAN-H.PZ2 GA 5X 50	75
4302 2	1/4" PZ-BITS 25MM SIZE 2	10
5614 6 160	SDS+HADR-DUAL 4W 6 X 160/100	1
5614 8 160	SDS+HADR-DUAL 4W 8 X 160/100	1
8108 6	UNIVERSAL PLUG GX PREMIUM 6MM	200
8108 8	UNIVERSAL PLUG GX PREMIUM 8MM	100
9003 1	VAROBOXX SIZE:1 EMPTY	1
9004 0 1	COVER INLAY VAROBOXX	1
9004 1 0	INSET BOX GREY SIDE.VAROBOXX 1	2
9004 1 0 1	DIVI.INSET BOX SIZE VAROBOXX 1	4
9004 1 5 10	INS.BOX YELL.5X10CM VAROBOXX 1	11
9004 1 10 10	INS.BOX BLUE10X10CM VAROBOXX 1	2



Article No.	Article Description	QTY
9003 1611	VAROBOXX CHI.SC.PAN-HEAD PZ GA	1

Chipboard Screw TX Panhead, GA **VAROBOXX**

- Assortment in VAROBOXX 1
- Drive: TX
- Galvanised steel

Contents

Article No.	Article Description	Quantity
1612 4 20	PAN-H TX15 CHIPB. GA 4X20	150
1612 4 25	PAN-H TX15 CHIPB. GA 4X25	250
1612 4 30	PAN-H TX15 CHIPB. ZP 4X30	200
1612 4 35	PAN-H TX15 CHIPB. GA 4X35	150
1612 4 40	PAN-H TX15 CHIPB. GA 4X40	125
1612 4 45	PAN-H TX15 CHIPB. GA 4X45	125
1612 4 50	PAN-H TX15 CHIPB. ZP 4X50	100
1612 45 20	PAN-H TX25 CHIPB. GA 4.5X 20	250
1612 45 35	PAN-H TX25 CHIPB. GA 4.5X 35	125
1612 45 40	PAN-H TX25 CHIPB. GA 4.5X 40	100
1612 45 50	PAN-H TX25 CHIPB. GA 4.5X 50	100
1612 45 60	PAN-H TX25 CHIPB. GA 4.5X 60	80
1612 5 30	PAN-H TX25 CHIPB. GA 5 X30	150
1612 5 40	PAN-H TX25 CHIPB. GA 5 X40	100
1612 5 50	PAN-H TX25 CHIPB. GA 5 X50	75
4303 15	1/4"TX-BITS 25MM TX 15	10
4303 25	1/4"TX-BITS 25MM TX 25	10
5614 6 160	SDS+HADR-DUAL 4W 6 X 160/100	1
5614 8 160	SDS+HADR-DUAL 4W 8 X 160/100	1
8108 6	UNIVERSAL PLUG GX PREMIUM 6MM	200
8108 8	UNIVERSAL PLUG GX PREMIUM 8MM	100
9003 1	VAROBOXX SIZE:1 EMPTY	1
9004 0 1	COVER INLAY VAROBOXX	1
9004 1 0	INSET BOX GREY SIDE.VAROBOXX 1	2
9004 1 0 1	DIVI.INSET BOX SIZE VAROBOXX 1	4
9004 1 5 10	INS.BOX YELL.5X10CM VAROBOXX 1	11
9004 1 10 10	INS.BOX BLUE10X10CM VAROBOXX 1	2



Article No.	Article Description	QTY
9003 1612	VAROBOXX CHIP.SC.PAN-HEAD TX GA	1

Rais.Counters.Head Scr.PZ7995 Ø15mm,A2

VAROBOXX

- Assortment in VAROBOXX 1
- Stainless Steel A2
- Head-Ø 4.5 mm
- Drive: PZ2

Contents

Article No.	Article Description	Quantity
1742 45 25	PLUMB.SEAL.SCR.15A2/A2 4.5X25	200
1742 45 35	PLUMB.SEAL.SCR.15A2/A2 4.5X35	100
1742 45 45	PLUMB.SEAL.SCR.15A2/A2 4.5X45	100
1742 45 60	PLUMB.SEAL.SCR.15A2/A2 4.5X60	75
1742 45 80	PLUMB.SEAL.SCR.15A2/A2 4.5X80	100
1742 45 100	PLUMB.SEAL.SCR.15A2/A2 4.5X100	50
1742 45 120	PLUMB.SEAL.SCR.15A2/A2 4.5X120	50
1742 45 150	PLUMBER SCREW 15A2/A2 4.5X150	20
4312 5 2	1/4"PZ-BIT 25MM SZ.2 BLACK 5*	10
9003 1	VAROBOXX SIZE:1 EMPTY	1
9004 0 1	COVER INLAY VAROBOXX	1
9004 1 0	INSET BOX GREY SIDE.VAROBOXX 1	2
9004 1 0 1	DIVI.INSET BOX SIZE VAROBOXX 1	4
9004 1 5 20	INS.BOX ORAN.5X20CM VAROBOXX 1	3
9004 1 10 10	INS.BOX BLUE10X10CM VAROBOXX 1	3
9004 1 10 15	INSETB.L-GR.10X15CM VAROBOXX 1	1



Article No.	Article Description	QTY
9003 1742	VAROBOXX RS.CO.U.HD SC15 A2/A2	1

Rais.Counters.Head Scr.PZ7995 Ø15mm A2/CU

VAROBOXX

- Assortment 1 in VAROBOXX 1
- Copper-plated stainless steel A2
- Head-Ø 4.5 mm
- Drive: PZ2

Contents

Article No.	Article Description	Quantity
1743 45 25	PLUMB.SEAL.SCRE.15A2/CU 4.5X25	200
1743 45 35	PLUMB.SEAL.SCRE.15A2/CU 4.5X35	200
1743 45 45	PLUMB.SEAL.SCRE.15A2/CU 4.5X45	100
1743 45 60	PLUMB.SEAL.SCRE.15A2/CU 4.5X60	75
1743 45 70	PLUMB.SEAL.SCRE.15A2/CU 4.5X70	100
1743 45 80	PLUMB.SEAL.SCRE.15A2/CU 4.5X80	100
1743 45 100	PLUMB.SEAL.SCR.15A2/CU 4.5X100	50
1743 45 120	PLUMB.SEAL.SCR.15A2/CU 4.5X120	50
1743 45 130	PLUMB.SEAL.SCR.15A2/CU 4.5X130	25
4312 5 1	1/4"PZ-BIT 25MM SZ.1 BLUE 5*	10
4312 5 2	1/4"PZ-BIT 25MM SZ.2 BLACK 5*	10
9003 1	VAROBOXX SIZE:1 EMPTY	1
9004 0 1	COVER INLAY VAROBOXX	1
9004 1 0	INSET BOX GREY SIDE.VAROBOXX 1	2
9004 1 0 1	DIVI.INSET BOX SIZE VAROBOXX 1	4
9004 1 5 20	INS.BOX ORAN.5X20CM VAROBOXX 1	3
9004 1 10 10	INS.BOX BLUE10X10CM VAROBOXX 1	3
9004 1 10 15	INSETB.L-GR.10X15CM VAROBOXX 1	1



Article No.	Article Description	QTY
9003 1743	VAROBOXX RS.CO.U.HD SC15 A2/CU	1

1K-PU Spray Gun Foam, 500 Plus **VAROBOXX**

Contents Art. No. 9003P 6800 8106:

Article No.	Article Description	Quantity
6800 8104	1K-PU-FOAM GUN METAL	1
6800 8106	1K-PU GUN FOAM 500+GREY	16
9003 4	VAROBOXX SIZE:4 EMPTY	1
9004 4 1	THERMO INSERT VAROBOXX4	1

Contents Art. No. 9003P 6800 8108:

Article No.	Article Description	Quantity
6800 8104	1K-PU-FOAM GUN METAL	1
6800 8108	1K-PU GUN FOAM 500+WHITE	16
9003 4	VAROBOXX SIZE:4 EMPTY	1
9004 4 1	THERMO INSERT VAROBOXX4	1



Article No.	Article Description	QTY
9003P 6800 8106	VAROBOXX 1K-PU GUN FOAM GREY	1
9003P 6800 8108	VAROBOXX 1K-PU GUN FOAM WHITE	1

Hammer Tacker Type 11 + 50,000 Staples

VAROBOXX

- Hammer tacker type 11 Prebena
- 50,000 staples type 140 10 mm
- In practical VAROBOXX size 1

Article No.	Article Description	QTY
9003 8350 1	VAROB. HAMMER T.TYPE11+STAPLES	1



Mortar Injection Set, **VAROBOXX**

• Assortment in VAROBOXX 2

Contents

Article No.	Article Description	Quantity
8150 345 5	INJECTION MORTAR FIT Z-B 345SF	2
8153 6	FIT MIXING NOZZLES	4
8153 24	CLEANING BRUSH 24MM	1
8153 345	FIT CARTR. APPL. GUN 235+345ML	1
8163 2	FIT-INJECTION GUN COAX 410ML	1
9003 2	BLOW-OUT PUMP 310MM	1
9004 0 1	VAROBOXX SIZE:2 EMPTY COVER INLAY VAROBOXX	1

Article No.	Article Description	QTY
9003 8150	VAROBOXX MORTAR INJECTION SET	1



Injection Mortar FIT Express **VAROBOXX**

High strength, fast setting 2-part mortar for expansion-free fastening of threaded rods and armoured irons down to -10 °C component temperature

- Can be worked down to -20 °C
- Styrene-free, hence odourless
- Side-by-Side cartridge containing 345 ml
- FÖRCH Fit fastens securely even with small edge distances and axial spacings
- Suitable for fastening high loads on concrete, solid and perforated brickwork and wood
- Can be used with perforated sleeves in perforated brickwork
- Suitable for dry and wet concrete, may also be applied in water-filled drill holes
- Waterproof
- High resistance to chemical action
- Can be used as a repair adhesive for concrete parts

Notes:

- Storage location must be cool, at least +5 °C, dry and dark
- Storage temperature: +5 °C to max. +35 °C
- Shelf life: see packaging

Contents

Article No.	Article Description	Quantity
8150 345 1	INJ.MORTAR FIT EXPRESS 345	6
8153 6	FIT MIXING NOZZLES	12
8153 345	FIT CARTR. APPL. GUN 235+345ML	1
9003 2	VAROBOXX SIZE:2 EMPTY	1
9004 0 1	COVER INLAY VAROBOXX	1

Article No.	Article Description	QTY
9003 8150 345	VAROBOXX INJ.MORT.FIT EXPRESS	1



Anchor Rods / Perforated Sleeves, **VAROBOXX**

- Product assortment in VAROBOXX 1
- Perforated sleeves made from nylon for hollow materials
- Anchor rods approved in accordance with general building inspectorate approval Z-21.3-1953 and Z-21.3-1977 in M8 and M10 dimensions for FIT Z-B and FIT Z-M

Contents

Article No.	Article Description	Quantity
8157 8 110	ANCHOR RODS TYPE C M8X110 GV	20
8157 10 130	ANCHOR RODS TYPE C M10X130 GV	10
8157 10 130 1	ANCHOR RODS TYPE C M10X130 A4	20
8158 13 100 1	FILTER BUSHING SH 13/100	10
8158 15 100 1	FILTER BUSHING SH 15/100	10
8158 20 85	FIT-FILTER BUSH. PLASTIC20X 85	10
8159 8 80	FIT INT. THR. SLEEVE GAL M8X80	10
8159 10 80	FIT IN. THR. SLEEVE GAL M10X80	10
8161 8 110	COMP. ANCH. ROD GAL 8/110	20
9003 1	VAROBOXX SIZE:1 EMPTY	1
9004 0 1	COVER INLAY VAROBOXX	1
9004 1 8	DEEP DRAWN INS.8COMP.VAROBOXX1	1

Article No.	Article Description	QTY
9003 8157	VAROBOXX ANCH.R./PERFOR.SLEEVE.	1



Universal Plug **VAROBOXX**

- Assortment in VAROBOXX 1

Contents

Article No.	Article Description	Quantity
8000 6	NYLON-EXPANSION ANCHOR F 6	100
8000 8	NYLON-EXPANSION ANCHOR F 8	50
8000 10	NYLON-EXPANSION ANCHOR F 10	25
8000 12	NYLON-EXPANSION ANCHOR F 12	20
8010 6 60	HOLLOW PLUG B 6 H 60	50
8010 8 80	HOLLOW PLUG B 8 H 80	25
8010 10 90	HOLLOW PLUG B 10 H 90	20
8020 6 40	NAIL PLUG PZ CSK HEAD 6X40	40
8020 6 60	NAIL PLUG PZ CSK HEAD 6X60	25
8055 39	PLASTERBOARD PLUG	25
8055 39 1	DUO-BIT F.PLASTERBOARD PLUG	1
8100 6	ALL-PURPOSE PLUG 6	100
8100 8	ALL-PURPOSE PLUG 8	50
8100 10	ALL-PURPOSE PLUG 10	25
8100 12	ALL-PURPOSE PLUG 12	20
8108 6	UNIVERSAL PLUG GX PREMIUM 6MM	100
8108 8	UNIVERSAL PLUG GX PREMIUM 8MM	50
8108 10	UNIVERSAL PLUG GX PREMIUM 10MM	25
8108 12	UNIVERSAL PLUG GX PREMIUM 12MM	15
8130 6	LIGHTWEIGHT CONCRETE ANCHOR 6	20
8130 8	LIGHTWEIGHT CONCRETE ANCHOR 8	10
8137 50	ISO-SPIRAL DOWEL 50	15
9003 1	VAROBOXX SIZE:1 EMPTY	1
9004 0 1	COVER INLAY VAROBOXX	1
9004 1 0	INSET BOX GREY SIDE.VAROBOXX 1	2
9004 1 0 1	DIVI.INSET BOX SIZE VAROBOXX 1	4
9004 1 5 10	INS.BOX YELL.5X10CM VAROBOXX 1	15



Article No.	Article Description	QTY
9003 8000	VAROBOXX DOWEL LIGHT-CONSTRUC.	1

Hollow Plug Metal **VAROBOXX**

- Assortment in VAROBOXX 1
- For fixing medium-heavy components on plasterboards and other board materials
- Suitable for electricians, heating, ventilation and sanitary installations, drywall and interior constructions
- Preassembled screw
- Rational, easy to spread with pliers
- Drive: PH

Contents

Article No.	Article Description	Quantity
8145 2	MOUNT.PLIERS F.HOLL.PLUG M4-M8	1
8145 4 38	LK-PH2 METAL HOLLOW PLUG 4X38	100
8145 4 45	LK-PH2 METAL HOLLOW PLUG 4X45	50
8145 5 52	LK-PH2 METAL HOLLOW PLUG 5X52	50
8145 5 65	LK-PH2 METAL HOLLOW PLUG 5X65	50
8145 6 52	LK-PH2 METAL HOLLOW PLUG 6X52	25
8145 6 65	LK-PH2 METAL HOLLOW PLUG 6X65	25
8145 8 53	LK-PH2 METAL HOLLOW PLUG 8X53	25
8145 8 66	LK-PH2 METAL HOLLOW PLUG 8X66	25
9003 1	VAROBOXX SIZE:1 EMPTY	1
9004 0 1	COVER INLAY VAROBOXX	1
9004 1 0	INSET BOX GREY SIDE.VAROBOXX 1	1
9004 1 0 1	DIVI.INSET BOX SIZE VAROBOXX 1	1
9004 1 10 10	INS.BOX BLUE10X10CM VAROBOXX 1	6
9004 1 10 30	INSETB.D-GR.10X30CM VAROBOXX 1	1



Article No.	Article Description	QTY
9003 8145	VAROBOXX HOLLOW PLUG METAL	1

Frame Screws Flat Head gv **VAROBOXX**

- Assortment in VAROBOXX 1
- Tested by ift-Rosenheim
- Head-Ø 12.5 mm
- Drive: TX 30
- Galvanised steel

Contents

Article No.	Article Description	Quantity
1751 92	FL-HE-TX30-FRAME SCR.ZN7.5X 92	50
1751 112	FL-HE-TX30-FRAME SCR.ZN7.5X112	50
1751 132	FL-HE-TX30-FRAME SCR.ZN7.5X132	50
1751 152	FL-HE-TX30-FRAME SCR.ZN7.5X152	25
1751 182	FL-HE-TX30-FRAME SCR.ZN7.5X182	50
1751 212	FL-HE-TX30-FRAME SCR.ZN7.5X212	25
4314 5 30	1/4"BIT 25MM TX30 RED 5*	10
4355 5	E6.3-1/4 BIT-HOLD.SNOW-WHIT 50	1
5613 6 260 1	SDS+HA.DR.TRIAL 6X260/120 5*	2
5613 65 260 1	SDS+HA.DR.TRIAL 6.5X260/120 5*	2
9003 1	VAROBOXX SIZE:1 EMPTY	1
9004 0 1	COVER INLAY VAROBOXX	1
9004 1 0	INSET BOX GREY SIDE.VAROBOXX 1	2
9004 1 5 10	INS.BOX YELL.5X10CM VAROBOXX 1	1
9004 1 5 20	INS.BOX ORAN.5X20CM VAROBOXX 1	3
9004 1 10 10	INS.BOX BLUE10X10CM VAROBOXX 1	1
9004 1 10 15	INSETB.L-GR.10X15CM VAROBOXX 1	2



Article No.	Article Description	QTY
9003 1751	VAROBOXX FR.SCR.FLAT HEAD GV	1

Frame Screws Ribbed Head, GA **VAROBOXX**

- Assortment in VAROBOXX 1
- Tested by ift-Rosenheim
- Head dia. 11 mm
- Drive: TX 30
- Galvanised steel

Contents

Article No.	Article Description	Quantity
1756 92	CSK-TX30-FRAME SCR. ZN 7.5X 92	75
1756 112	CSK-TX30-FRAME SCR. ZN 7.5X112	75
1756 132	CSK-TX30-FRAME SCR. ZN 7.5X132	75
1756 152	CSK-TX30-FRAME SCR. ZN 7.5X152	40
1756 182	CSK-TX30-FRAME SCR. ZN 7.5X182	40
1756 212	CSK-TX30 FRAME SCR. ZN 7.5X212	40
1758 0	CAP F.CSK-FRAME SCR.WHITE	200
1758 3	CAP F.CSK-FRAME SCR.DKLBRAUN	200
1758 9	CAP F.CSK-FRAME SCR.LIGHT-GRAY	200
4303 30	1/4"TX-BITS 25MM TX 30	10
4355 3	E6.3-1/4 BIT MAGNET HOLDER50MM	1
5613 6 260 1	SDS+HA.DR.TRIAL 6X260/120 5*	2
5613 65 260 1	SDS+HA.DR.TRIAL 6.5X260/120 5*	2
9003 1	VAROBOXX SIZE:1 EMPTY	1
9004 0 1	COVER INLAY VAROBOXX	1
9004 1 0	INSET BOX GREY SIDE.VAROBOXX 1	2
9004 1 5 10	INS.BOX YELL.5X10CM VAROBOXX 1	3
9004 1 5 20	INS.BOX ORAN.5X20CM VAROBOXX 1	2
9004 1 10 10	INS.BOX BLUE10X10CM VAROBOXX 1	1
9004 1 10 15	INSETB.L-GR.10X15CM VAROBOXX 1	2



Article No.	Article Description	QTY
9003 1756	VAROBOXX FSK.TX30 FRAME SCR.GA	1

Frame Screws Cylinder Head, GA **VAROBOXX 1**

- Assortment in VAROBOXX 1
- Tested by ift-Rosenheim
- Head dia. 7.5 mm
- Drive: TX 25
- Galvanised steel

Contents

Article No.	Article Description	Quantity
1757 92	TX25-FR.SC.WITHO.HD ZN 7.5X 92	100
1757 112	TX25-FR.SC.WITHO.HD ZN 7.5X112	100
1757 132	TX25-FR.SC.WITHO.HD ZN 7.5X132	100
1757 152	TX25-FR.SC.WITHO.HD ZN 7.5X152	50
1757 182	TX25-FR.SC.WITHO.HD ZN 7.5X182	100
1757 212	TX25-FR.SC.WITHO.HD ZN 7.5X212	50
4303 25	1/4"TX-BITS 25MM TX 25	10
4355 3	E6.3-1/4 BIT MAGNET HOLDER50MM	1
5613 6 260 1	SDS+HA.DR.TRIAL 6X260/120 5*	2
5613 65 260 1	SDS+HA.DR.TRIAL 6.5X260/120 5*	2
9003 1	VAROBOXX SIZE:1 EMPTY	1
9004 0 1	COVER INLAY VAROBOXX	1
9004 1 0	INSET BOX GREY SIDE.VAROBOXX 1	2
9004 1 5 10	INS.BOX YELL.5X10CM VAROBOXX 1	1
9004 1 5 20	INS.BOX ORAN.5X20CM VAROBOXX 1	3
9004 1 10 10	INS.BOX BLUE10X10CM VAROBOXX 1	1
9004 1 10 15	INSETB.L-GR.10X15CM VAROBOXX 1	2



Article No.	Article Description	QTY
9003 1757	VAROBOXX TX25FRAME SC.WITHO.HD	1

Frame Screws Counters.Head, gv **VAROBOXX**

- Assortment in VAROBOXX 1
- Tested by ift-Rosenheim
- Head- Ø. 8.5 mm
- Drive: TX 30

Contents

Article No.	Article Description	Quantity
1759 92	TX30-FR.SC.WITHO.HD ZN 7.5X 92	100
1759 112	TX30-FR.SC.WITHO.HD ZN 7.5X112	100
1759 132	TX30-FR.SC.WITHO.HD ZN 7.5X132	100
1759 152	TX30-FR.SC.WITHO.HD ZN 7.5X152	50
1759 182	TX30-FR.SC.WITHO.HD ZN 7.5X182	100
1759 212	TX30-FR.SC.WITHO.HD ZN 7.5X212	50
4314 5 30	1/4"BIT 25MM TX30 RED 5*	10
4355 5	E6.3-1/4 BIT-HOLD.SNOW-WHIT 50	1
5613 6 260 1	SDS+HA.DR.TRIAL 6X260/120 5*	2
5613 65 260 1	SDS+HA.DR.TRIAL 6.5X260/120 5*	2
9003 1	VAROBOXX SIZE:1 EMPTY	1
9004 0 1	COVER INLAY VAROBOXX	1
9004 1 0	INSET BOX GREY SIDE.VAROBOXX 1	2
9004 1 5 10	INS.BOX YELL.5X10CM VAROBOXX 1	1
9004 1 5 20	INS.BOX ORAN.5X20CM VAROBOXX 1	3
9004 1 10 10	INS.BOX BLUE10X10CM VAROBOXX 1	1
9004 1 10 15	INSETB.L-GR.10X15CM VAROBOXX 1	2



Article No.	Article Description	QTY
9003 1759	VAROBOXX TX30 FR.SCR.C.HD GV	1

AIR Glazing Blocks Plastic **VAROBOXX**

- Range in VAROBOXX 1
- Ageing resistant
- High load capacity 150 – 160 kg
- Compatible with sealants
- Block length: 100 mm
- **Material: Polypropylene**

Contents

Article No.	Article Description	Quantity
5613 6 260 1	SDS+HA.DR.TRIAL 6X260/120 5*	1
5613 65 260 1	SDS+HA.DR.TRIAL 6.5X260/120 5*	1
8330 65	BLOCK TROWEL WOOD.HANDLE 65MM	1
8331 24 2	GLAZING BLOCK AIR BLUE 24X2	100
8331 24 3	GLAZING BLOCK AIR RED 24X3	50
8331 24 4	GLAZING BLOCK AIR YELLOW 24X4	50
8331 24 5	GLAZING BLOCK AIR GREEN 24X5	50
8331 24 6	GLAZING BLOCK AIR BLACK 24X6	50
9003 1	VAROBOXX SIZE:1 EMPTY	1
9004 0 1	COVER INLAY VAROBOXX	1
9004 1 0	INSET BOX GREY SIDE.VAROBOXX 1	1
9004 1 10 15	INSETB.L-GR.10X15CM VAROBOXX 1	6



Article No.	Article Description	QTY
9003 8331	VAROBOXX GLAZING BLOCKS PLAST.	1

Glazing Blocks Wood **VAROBOXX**

- Assortment VAROBOXX 1
- According to the technical guidelines of the glazier trade
- Block length: 80 mm
- **Material: Beech wood**

Contents

Article No.	Article Description	Quantity
5613 6 260 1	SDS+HA.DR.TRIAL 6X260/120 5*	1
5613 65 260 1	SDS+HA.DR.TRIAL 6.5X260/120 5*	1
8330 65	BLOCK TROWEL WOOD.HANDLE 65MM	1
8333 20 1	GLAZING BLOCK WOOD NATURE 20X1	100
8333 20 2	GLAZING BLOCK WOOD RED 20X2	100
8333 20 3	GLAZING BLOCK WOOD GREEN 20X3	100
8333 20 4	GLAZING BLOCK WOOD YELLOW 20X4	100
8333 20 5	GLAZING BLOCK WOOD BLUE 20X5	50
8333 20 6	GLAZING BLOCK WOOD BLACK 20X6	50
9003 1	VAROBOXX SIZE:1 EMPTY	1
9004 0 1	COVER INLAY VAROBOXX	1
9004 1 0	INSET BOX GREY SIDE.VAROBOXX 1	1
9004 1 10 15	INSETB.L-GR.10X15CM VAROBOXX 1	6



Article No.	Article Description	QTY
9003 8333	VAROBOXX GLAZING BLOCKS WOOD	1

Windowsill Screw Sheet Metal Thread, A2

VAROBOXX

- Assortment in VAROBOXX 1
- Contents: similar to DIN 7981
- Drive: PZ 2 / TX 20
- Partly with attached permanently elastic polyamide washer
- Partly with extra big head

Contents

Article No.	Article Description	Quantity
1730 1 39 25	TX-KK-WIN.SCR.SH-THR.3.9X25 A2	50
1732 1 39 25	TX-KK-WIN.SCR. WO-SH.3.9X25 A2	200
1734 1 39 25	KK-WIN.S.DR.T SH-THR.3.9X25 A2	200
1736 1 39 19	WIND.SC.SH-THR.3.9X19 A2	200
1736 1 39 25	WIND.SC.SH-THR.3.9X25 A2	125
1736 2 39 19	WIND.SC.SH-THR.3.9X19 A2 BRUN.	250
1736 2 39 25	WIND.SC.SH-THR.3.9X25 A2 BRUN.	250
1736 3 39 19	WIND.SC.SH-THR.3.9X19 A2 WHITE	250
1736 3 39 25	WIND.SC.SH-THR.3.9X25 A2 WHITE	250
1737 1 39 25	WIND.SC.WO-THR.3.9X25 A2	250
1737 2 39 25	WIND.SC.WO-THR.3.9X25 A2 BRUN.	250
1737 3 39 25	WIND.SC.WO-THR.3.9X25 A2 WHITE	200
1738 1 39 22	WIN.SCR.BIG HD SH-ME.3.9X22 A2	200
1738 2 39 22	W.SC.BIG HD SH-M.3.9X22 A2 BRU	200
1738 3 39 22	W.SC.BIG HD SH-M.3.9X22 A2 WHI	200
4302 2	1/4"PZ-BITS 25MM SIZE 2	10
9003 1	VAROBOXX SIZE:1 EMPTY	1
9004 0 1	COVER INLAY VAROBOXX	1
9004 1 0	INSET BOX GREY SIDE.VAROBOXX 1	2
9004 1 0 1	DIVI.INSET BOX SIZE VAROBOXX 1	5
9004 1 5 10	INS.BOX YELL.5X10CM VAROBOXX 1	3
9004 1 10 10	INS.BOX BLUE10X10CM VAROBOXX 1	6



Article No.	Article Description	QTY
9003 1736	VAROBOXX WINDOWSILL SCREW A2	1

Electrical Installation **VAROBOXX**

• Assortment in VAROBOXX 1

Contents

Article No.	Article Description	Quantity
3706 25 2	TER.CHOC STRIP WHI.UP TO2.5QMM	10
3713 05 135	CBL END SLE.ISO.DIN/B 0.5N WHI	400
3713 075 14	CBL END SLE.ISO.DIN 0.75N GREY	400
3713 1 14	CBL END SLE.ISO.DIN/B 1N RED	400
3713 15 14	CBL END SLE.ISO.DIN/B 1.5N BLA	400
3713 25 15	CBL END SLE.ISO.DIN/A 2.5NBLUE	300
3733 3	HEAT SHRINK TUBING IK 100MM3/1	25
3733 6	HEAT SHRINK TUBING IK 100MM6/2	25
3733 9	HEAT SHRINK TUBING IK 100MM9/3	25
3733 12	HEAT SHRINK TUBING IK100MM12/4	25
3740 1	RO(10M)ISOT.0.15X12MM VDE BLAC	1
3740 2	RO(10M)ISOT.0.15X12MM VDE RED	1
3740 4	RO(10M)ISOT.0.15X12MM VDE BLUE	1
3740 5	RO(10M)ISOT.0.15X12MM VDE YELL	1
3790 4	MULTICORE CABLE END PLIERS 143	1
4264 31	VOLT.TESTER GS 3MM	1
8448 1 16	THREAD.CABLE JOINT METRIC M16	20
8448 1 20	THREAD.CABLE JOINT METRIC M20	10
8448 1 25	THREAD.CABLE JOINT METRIC M25	5
8448 2 16	COUNTERNUT METRIC M16	25
8448 2 20	COUNTERNUT METRIC M20	20
8448 2 25	COUNTERNUT METRIC M25	10
8450 1 3	PLUG-IN GREY 1.0-2.5MM ² 3-POLE	50
8450 1 5	PLUG-IN GREY 1.0-2.5MM ² 5-POLE	50
8450 4 3	CONNECT.TERM.RELEASE.3-POLE	25
8450 4 5	CONNECT.TERM.RELEASE.5-POLE	20
8450 7 8	CONN.CLAMP 0,5-2,5MM ² 8POL.	25
9003 1	VAROBOXX SIZE:1 EMPTY	1
9004 0 1	COVER INLAY VAROBOXX	1
9004 1 0	INSET BOX GREY SIDE.VAROBOXX 1	2
9004 1 0 1	DIVI.INSET BOX SIZE VAROBOXX 1	2
9004 1 5 5	INSET BOX RED 5X5CM VAROBOXX1	8
9004 1 5 10	INS.BOX YELL.5X10CM VAROBOXX 1	10



Article No.	Article Description	QTY
9003 8450 8848	VAROBOXX ELECTR.INSTALLATION	1

Cable Ties Black **VAROBOXX**

- Assortment in VAROBOXX 2
- Material: Polyamide 6.6
- Material class: UL94V-2
- Temperature resistant from -55 °C up to +100 °C

Contents

Article No.	Article Description	Quantity
3750 25 102	CABLE TIE 2.6X98 BLACK	300
3750 35 145	CABLE TIE 3.5X145 BLACK	300
3750 35 215	CABLE TIE 3.5X200 BLACK	1000
3750 47 285	CABLE TIE 4.7X285 BLACK	300
3750 47 360	CABLE TIE 4.7X360 BLACK	100
9003 2	VAROBOXX SIZE:2 EMPTY	1
9004 0 1	COVER INLAY VAROBOXX	1

Article No.	Article Description	QTY
9003 3750	VAROBOXX CABLE TIES BLACK	1



Cable Ties White **VAROBOXX**

- In assortment VAROBOXX 2
- Material: polyamide 6.6
- Material class: UL94V-2
- Temperature resistant from -55° to +100°

Contents

Article No.	Article Description	Quantity
3751 25 102	CABLE TIE 2.6X98 WHITE	300
3751 35 145	CABLE TIE 3.5X145 WHITE	300
3751 35 215	CABLE TIE 3.5X200 WHITE	1000
3751 47 285	CABLE TIE 4.7X285 WHITE	300
3751 47 360	CABLE TIE 4.7X360 WHITE	100
9003 2	VAROBOXX SIZE:2 EMPTY	1
9004 0 1	COVER INLAY VAROBOXX	1

Article No.	Article Description	QTY
9003 3751	VAROBOXX CABLE TIE WHITE	1



Cable Connector Electro **VAROBOXX**

• In assortment VAROBOXX 1

Contents

Article No.	Article Description	Quantity
3700 851	CRIMP CNCTR-RED INS FEMALE 6,3	50
3700 852	CRIMP CNCTR-BLUE INS FEM.6.3MM	50
3700 901	CRIMP CNCTR-RED FEMALE 6,3 901	100
3700 902	CRIMP CNCTR-BLUE FEM.6.3MM 902	100
3700 906	CRIMP CNCTR-RED FEMALE 4,8 906	100
3700 907	CRIMP CNCTR-RED FEMALE 2,8 907	100
3700 908	CRIMP CNCTR-RED MALE 2,8 908	100
3700 909	CRIMP CNCTR-RED MALE 4,8 909	100
3700 910	CRIMP CNCTR-BLUE MALE 4,8 910	100
3700 912	CRIMP CNCTR-RED RING M4 912	100
3700 913	CRIMP CNCTR-RED RING M5 913	100
3700 915	CRIMP CNCTR-BLUE RING M4 915	100
3700 916	CRIMP CNCTR-BLUE RING M5 916	100
3700 917	CRIMP CNCTR-BLUE RING M6 917	100
3700 918	CRIMP CNCTR-BLUE RING M8 918	100
3700 924	CRIMP CNCTR-RED MALE BULLET 4M	100
3700 925	CRIMP CNCTR-BLUE MALE BULLET 5	100
3700 926	CRIMP CNCTR RED 4MM 926	50
3700 927	CRIMP CNCTR-BLUE FEMALE BULLET	50
3700 933	CRIMP CNCTR-RED M6 933	100
3700 934	CRIMP CNCTR-BLUE FEMALE 4,8	100
3700 936	CRIMP CNCTR-BLUE MALE 6,3 936	100
3700 937	CRIMP CNCTR-RED MALE 6,3 937	100
3700 939	CRIMP CNCTR-BLUE BUTT 939	100
3700 941	BUTT CONNECTOR RED 941	100
3701 957	CONNECTOR SNAP-ON BLUE 957	50
3701 962	CONNECTOR SNAP-ON RED 962	50
3790 11	CRIMP PLIERS INSULATED 900	1
9003 1	VAROBOXX SIZE:1 EMPTY	1
9004 0 1	COVER INLAY VAROBOXX	1
9004 1 0	INSET BOX GREY SIDE.VAROBOXX 1	1
9004 1 0 1	DIVI.INSET BOX SIZE VAROBOXX 1	2
9004 1 5 5	INSET BOX RED 5X5CM VAROBOXX1	24
9004 1 10 30	INSETB.D-GR.10X30CM VAROBOXX 1	1

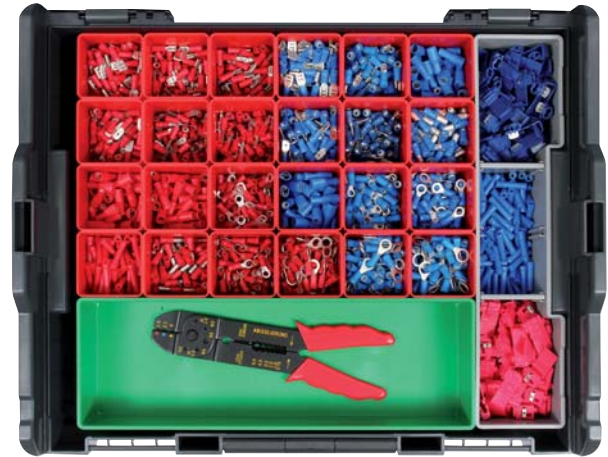

Article No.	Article Description	QTY
9003 3700	VAROBOXX CABLE CONNECT.ELECTR.	1

Hanger Bolts M8, GA **VAROBOXX**

- In assortment VAROBOXX 1
- Drive: TX 25
- Galvanised steel

Contents

Article No.	Article Description	Quantity
1861 8 60	HANGER BOLTS TX25 ZP 8X60	100
1861 8 80	HANGER BOLTS TX25 ZP 8X80	100
1861 8 100	HANGER BOLTS TX25 ZP 8X100	50
1861 8 120	HANGER BOLTS TX25 ZP 8X120	100
1861 8 140	HANGER BOLTS TX25 ZP 8X140	50
1861 8 160	HANGER BOLTS TX25 ZP 8X160	50
4303 25	1/4"TX-BITS 25MM TX 25	10
4666 3 8	HANGER SCREWDRIVER BIT M8	1
5613 10 160	SDS+HA-DR TRIAL 10X160/100 5*	3
8100 10	ALL-PURPOSE PLUG 10	150
9003 1	VAROBOXX SIZE:1 EMPTY	1
9004 0 1	COVER INLAY VAROBOXX	1
9004 1 0	INSET BOX GREY SIDE.VAROBOXX 1	2
9004 1 0 1	DIVI.INSET BOX SIZE VAROBOXX 1	1
9004 1 5 20	INS.BOX ORAN.5X20CM VAROBOXX 1	3
9004 1 10 10	INS.BOX BLUE10X10CM VAROBOXX 1	3
9004 1 10 15	INSETB.L-GR.10X15CM VAROBOXX 1	1



Article No.	Article Description	QTY
9003 1861 1	VAROBOXX HANGER SCR.TX25 M8 GA	1

Hanger Bolts M10, GA **VAROBOXX**

- In assortment VAROBOXX 1
- Drive: TX 25
- Galvanised steel

Contents

Article No.	Article Description	Quantity
1861 10 60	HANGER BOLTS TX25 ZP 10X 60	50
1861 10 80	HANGER BOLTS TX25 ZP 10X 80	50
1861 10 100	HANGER BOLTS TX25 ZP 10X100	25
1861 10 120	HANGER BOLTS TX25 ZP 10X120	50
1861 10 140	HANGER BOLTS TX25 ZP 10X140	25
1861 10 160	HANGER BOLTS TX25 ZP 10X160	25
4303 25	1/4"TX-BITS 25MM TX 25	10
4666 3 10	HANGER SCREWDRIVER BIT M10	1
5613 12 160	SDS+HA-DR TRIAL 12X160/100 5*	3
8100 12	ALL-PURPOSE PLUG 12	75
9003 1	VAROBOXX SIZE:1 EMPTY	1
9004 0 1	COVER INLAY VAROBOXX	1
9004 1 0	INSET BOX GREY SIDE.VAROBOXX 1	2
9004 1 0 1	DIVI.INSET BOX SIZE VAROBOXX 1	1
9004 1 5 20	INS.BOX ORAN.5X20CM VAROBOXX 1	3
9004 1 10 10	INS.BOX BLUE10X10CM VAROBOXX 1	3
9004 1 10 15	INSETB.L-GR.10X15CM VAROBOXX 1	1



Article No.	Article Description	QTY
9003 1861	VAROBOXX HANGER SC.TX25 M10 GA	1

Quick Fastener HakoFix Type 27 **VAROBOXX**

- In assortment VAROBOXX 1
- Stud bolt DIN 976 shape A
- Galvanised steel

Contents

Article No.	Article Description	Quantity
1828 8 40	STUD BOLT DIN 976 4.6 GA 8X 40	100
1828 8 50	STUD BOLT DIN 976 4.6 GA 8X 50	50
1828 8 60	STUD BOLT DIN 976 4.6 GA 8X 60	50
1828 8 70	STUD BOLT DIN 976 4.6 GA 8X 70	50
1828 8 80	STUD BOLT DIN 976 4.6 GA 8X 80	50
1828 8 100	STUD BOLT DIN 976 4.6 GA 8X100	25
1828 10 50	STUD BOLT DIN976 4.6 GA 10X 50	40
1828 10 60	STUD BOLT DIN976 4.6 GA 10X 60	25
1828 10 80	STUD BOLT DIN976 4.6 GA 10X 80	25
2001 8	HEX NUT 934-8 GA 8	200
2001 10	HEX NUT 934-8 GA 10	100
8668 1 8	HAKOFIX QUICK FASTEN.TYPE27 M8	80
8668 1 10	HAKOFIX QUICK FASTEN.TYPE27M10	60
9003 1	VAROBOXX SIZE:1 EMPTY	1
9004 0 1	COVER INLAY VAROBOXX	1
9004 1 0	INSET BOX GREY SIDE.VAROBOXX 1	2
9004 1 5 10	INS.BOX YELL.5X10CM VAROBOXX 1	9
9004 1 10 10	INS.BOX BLUE10X10CM VAROBOXX 1	3



Article No.	Article Description	QTY
9003 8668 27	VAROBOXX HAKOFIX TYPE 27	1

Articulated Pipe Clamp M8 **VAROBOXX**

- In assortment VAROBOXX 4
- Connection: M8

Contents

Article No.	Article Description	Quantity
8601 15 19	PIPE CLAMP 3/8" 15-19 M8	100
8601 20 23	PIPE CLAMP 1/2" 20-23 M8	100
8601 25 28	PIPE CLAMP 3/4" 25-28 M8	75
8601 32 35	PIPE CLAMP 1" 32-35 M8	50
9003 4	VAROBOXX SIZE:4 EMPTY	1
9004 0 1	COVER INLAY VAROBOXX	1
9004 1 8	DEEP DRAWN INS.8COMP.VAROBOXX1	1
9004 3 2	INS.BOX INS.W.BOX VAROBOXX3+4	1
9004 3 3	PART.PLATE FRAME VAROBOXX 3+4	1
9004 4 2	SLO.PART.PLATE SHORT VAROBOXX4	1
9004 4 5	PART.PLATE LONG VAROBOXX 4	2

Article No.	Article Description	QTY
9003 8601	VAROBOXX PIPE CLAMP 3/8"-1" M8	1



Torro Hose Clamps W 2

- Assortment in VAROBOXX 1
- Housing not welded or riveted
- Does not twist away when tightened
- Short housing saddle ensures optimum fit and uniform contact pressure over the entire circumference
- Hexagon screw with slot head or slot/cross head combination
- Stamped band with raised edges prevents damage to the hose wall

Contents

Article No.	Article Description	Quantity
3200 8 12	HOSE CL TOR 7.5MM SW6 W2 8-12	50
3200 10 16	HOSE CL TOR 7.5MM SW6 W2 10-16	50
3200 12 20	HOSE CL TOR 9MM SW7 W2 12-22	25
3200 16 25	HOSE CL TOR 9MM SW7 W2 16-27	25
3200 20 32	HOSE CL TOR 9MM SW7 W2 20-32	40
3200 25 40	HOSE CL TOR 9MM SW7 W2 25-40	25
3200 32 50	HOSE CL TOR 9MM SW7 W2 32-50	25
3200 40 60	HOSE CL TOR 9MM SW7 W2 40-60	10
3200 60 80	HOSE CL TOR 9MM SW7 W2 60-80	5
3200 70 90	HOSE CL TOR 9MM SW7 W2 70-90	5
9003 1	VAROBOXX SIZE:1 EMPTY	1
9004 0 1	COVER INLAY VAROBOXX	1
9004 1 0	INSET BOX GREY SIDE VAROBOXX 1	2
9004 1 0 1	DIVI.INSET BOX SIZE VAROBOXX 1	2
9004 1 10 10	INS.BOX BLUE10X10CM VAROBOXX 1	3
9004 1 10 15	INSETB.L-GR.10X15CM VAROBOXX 1	3



Article No.	Article Description	QTY
9003 3200	VAROBOX HOSE CLAMP W2 TORRO	1

Work Lights Set Sun- / Multimatch FÖRCH*****

- Powerful CRI COB-LED battery lights
- 5 pieces

Your Advantage / Benefit

- Work independently of the mains
- Stable, sturdy and waterproof
- Long service life
- Colour temperature close to daylight
- Glass lens resistant to solvents, can be cleaned daily

Application

- For optimal colour recognition in the evaluation of various paint mixtures of a hue
- Ideal for use at in cleaning / polishing and painting preparatory work as the lamp makes sanding marks, polishing holograms and other surface defects visible



Article No.	Article Description	QTY
9003 5423	VAROBOXX DAYL.SET SUN/MUL 5*	1

Scope of delivery:

- 1x Art. No. 5423 93: Work light Multimatch 25 W FÖRCH 5*
- 1x Art. No. 5423 94: Work light Sunmatch 5 W FÖRCH 5*

Cylinder Saws HSS bi-metal **VAROBOXX**

- In VAROBOXX 2
- Max. cutting depth: 38 mm
- Application in cast iron, steel, copper, bronze, aluminum, plastics, plasterboard and wood
- 1 each cylinder saw Ø 19, 22, 30, 35, 40, 44, 51, 60, 68, 76, 83, 92, 95, 102 and 114 mm
- 1 each shank AS 2 (Ø 19–30 mm) and AS 3 (Ø 35–114 mm)
- 1 centre drill

Contents

Article No.	Article Description	Quantity
5750 19	BI-METAL CYLINDER CUTTER 19	1
5750 22	BI-METAL CYLINDER CUTTER 22	1
5750 30	BI-METAL CYLINDER CUTTER 30	1
5750 35	BI-METAL CYLINDER CUTTER 35	1
5750 40	BI-METAL CYLINDER CUTTER 40	1
5750 44	BI-METAL CYLINDER CUTTER 44	1
5750 51	BI-METAL CYLINDER CUTTER 51	1
5750 60	BI-METAL CYLINDER CUTTER 60	1
5750 68	BI-METAL CYLINDER CUTTER 68	1
5750 76	BI-METAL CYLINDER CUTTER 76	1
5750 83	BI-METAL CYLINDER CUTTER 83	1
5750 92	BI-METAL CYLINDER CUTTER 92	1
5750 95	BI-METAL CYLINDER CUTTER 95	1
5750 102	BI-METAL CYLINDER CUTTER 102	1
5750 114	BI-METAL CYLINDER CUTTER 114	1
5751 2	SHANK AS 2	1
5751 3	SHANK AS 3	1
5751 80	CENTRE DRILL 6.35X80MM	1
9003 2	VAROBOXX SIZE:2 EMPTY	1
9004 0 1	COVER INLAY VAROBOXX	1
9004 2 5	CYLINDER SAW INSERT VAROBOXX2	1

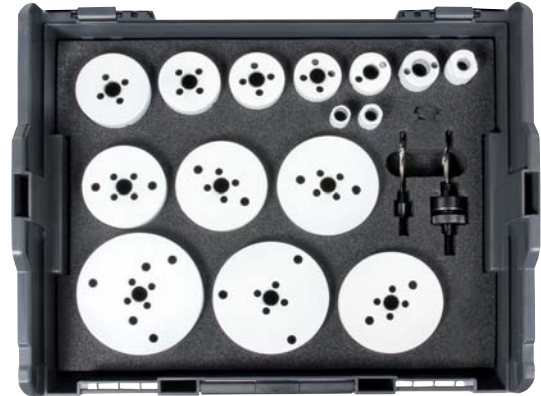

Article No.	Article Description	QTY
9003 5750	VAROBOXX CYLINDER SAWS 19-114	1

Impact Drilling Screwdriver 630 Watt **VAROBOXX**

- range in VAROBOXX 2
- with quick chuck, forward and reverse running, speed regulation and percussion
- direct-bit recording in the drive spindle for screwing
- spiral drill bit set TIN from 1.0 to 10.0, 19 pce.

Contents

Article No.	Article Description	Quantity
5325 570	FÖRCH-IMPACT HAMMER DRILL 630W	1
5509 5503	DRILL SET TIN 1.0-10.0 19-PCS	1
9003 2	VAROBOXX SIZE:2 EMPTY	1
9004 0 1	COVER INLAY VAROBOXX	1
9004 2 10	DRILLING MACH.INSERT VAROBOXX2	1

Article No.	Article Description	QTY
9003 5325	VAROBOXX IMP.SCR.DRIVER FÖRCH	1



Vitas 45 **VAROBOXX** compressor

- in VAROBOXX 4
- Compact and lightweight construction
- Ideal for repair and finishing work
- Drywall construction, interior construction, carpenters and joiners, plumbing
- Ideal for the pressure and leak testing of pipe systems
- Rubberised feet for optimum safety against overturning
- Oil-free compressor

Contents

Article No.	Article Description	Quantity
5357 45	COMPRESSOR VITAS 45	1
9003 4	VAROBOXX SIZE:4 EMPTY	1
9004 4 14	PE-FOAMBASE FOR VAROBOXX4	1

Article No.	Article Description	QTY
9003 5357 1	VAROBOXX COMPRESSOR VITAS 45	1



Cutting and Grinding Pack 36-pce **VAROBOXX**

- Assortment in VAROBOXX 1
- Package with custom range of components for cutting, grinding and rough machining
- Cercore cutting disc with highest cutting performance and service life
- Cool Vision rough machining disc for precise work
- Hard vulcanised fibre discs for highest stripping performance
- Efficient lamellar disc with plastic backing plate that can be cut to size
- Red non-woven web and vulcanised fibre discs with ceramic grain
- Cutting, grinding and rough machining discs for steel, stainless steel and non-ferrous metals
- Safety at work with earplugs and Eta Klar safety goggles
- Suitable angle grinder: Art. No. 5325 5, 125 27

Contents

Article No.	Article Description	Quantity
5400 907 1	"ETA" CLEAR SAFETY GLASSES	1
5402 4 10	P(10P)EAR PLUGS SZ.L	1
5803 125 12	PROF.CUTTING DISC ALU 125X1.2	5
5803 7 125 60	GRIND.DISC ALU 125X6.0	1
5804 125 30	GRIND.DISC GREEN FLOW 125X3.0	2
5808 5 125 10	CUTT.DISC ST/INOX 125X1.0 5*	5
5808 5 125 10 1	CUTT.DI.ST/SS CERCORE125/10 5*	5
5809 125 40	GRINDING D.COOL VISION 125X4.0	2
5811 125 19	CUT.+GRIND. DISC 2IN1 125X1.9	2
5814 5 125 70	GRIND.DISC STE/INOX 125X7.0 5*	1
5901 1	BACK UP PAD M14 125MM	1
5901 2 36	VUL.FIB.DISC CERAM.D125 P36 5*	5
5902 125 36	TOUGH VULCAN FIBRE D. D125 P36	1
5949 5 125 40	LAM. D. EFFICIENT 125 P40 5*	1
5959 125 4	NYL/CER GR.FL.GWT RED125MM 5*	1
5972 125 40	LAMELL.DISC INOX 5* 125 S P40	1
5973 125 7	STR.FL.C.D.R.GWT 125X22 5*	1
9003 1	VAROBOXX SIZE:1 EMPTY	1
9004 0 1	COVER INLAY VAROBOXX	1
9004 1 0	INSET BOX GREY SIDE.VAROBOXX 1	1
9004 1 2	CUTTING DISC INSETB.VAROBOXX1	4



Article No.	Article Description	QTY
9003 5808 35	VAROBOXX CUTT-GRINDPAP.36-PCE	1

Tyre Mould Repair Case 4.5 mm/6 mm

VAROBOXX

- Range in VAROBOXX 4
- Including consumables, tools and protective equipment
- Combined internal / external repair of tread punctures in radial and cross-ply tyres
- Self-vulcanisation in connection with special cement
- Suitable for run-flat tyres
- TÜV certified repair methods
- 5 years shelf life of the mushroom plugs
- Made In Germany



Contents

Article No.	Article Description	Quantity
3407 7	STITCHER 3.5MM	1
3560 1 1 0	BRUSH WITH TIN SREW TOP	2
3560 1 3	LIQUID BUFFER SPRAY 500ML	1
3560 1 6	TB(25G)SPECIAL BLUE CEMENT	1
3560 1 7	CAN(225G)SPECIAL BLUE CEMENT	1
3560 1 9	CAN(175G)INNER-LINER SEALER	1
3560 3 45 8	PCK(8)TYRE REPAIR PLUGS 4.5MM	1
3560 3 60 8	PCK(8)TYRE REPAIR PLUGS 6.0MM	1
3560 5 1 38	GRINDING BALL W. SHAFT Ø38MM	1
3560 5 6	HM-BUR FOR TYRE REPAIR 6MM	1
3560 5 45	HM-BUR FOR TYRE REPAIR 4.5MM	1
3560 99	RUN FLAT TYRE TEMPLATE	1
4000 180	COMBINATION PLIERS 180MM	1
4761 1	UNIVERSAL KNIFE WITH CUTTER 1	1
5325 570	FÖRCH-IMPACT HAMMER DRILL 630W	1
5400 2221	SAFETY GOGGLES FUN-CLEAR	1
5405 91 9	FINE KNITTED GLOVE PU GREY 9	1
5410 75 1	MICROFIBRE CLOTH BLUE 40X40CM	1
5861 1 60 1	ROUND BRUSH ST B20MM D60MM	1
9003 4	VAROBOXX SIZE:4 EMPTY	1
9004 0 1	COVER INLAY VAROBOXX	1
9004 1 0	INSET BOX GREY SIDE.VAROBOXX 1	2
9004 1 5 10	INS.BOX YELL.5X10CM VAROBOXX 1	2
9004 1 10 10	INS.BOX BLUE10X10CM VAROBOXX 1	2
9004 1 10 15	INSETB.L-GR.10X15CM VAROBOXX 1	1
9004 1 10 30	INSETB.D-GR.10X30CM VAROBOXX 1	1
9004 3 2	INS.BOX INS.W.BOX VAROBOXX3+4	1
9004 3 3	PART.PLATE FRAME VAROBOXX 3+4	1
9004 4 2	SLO.PART.PLATE SHORT VAROBOXX4	2

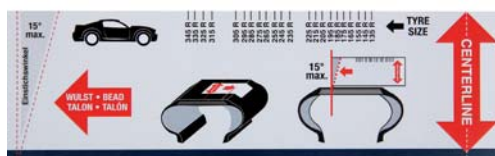
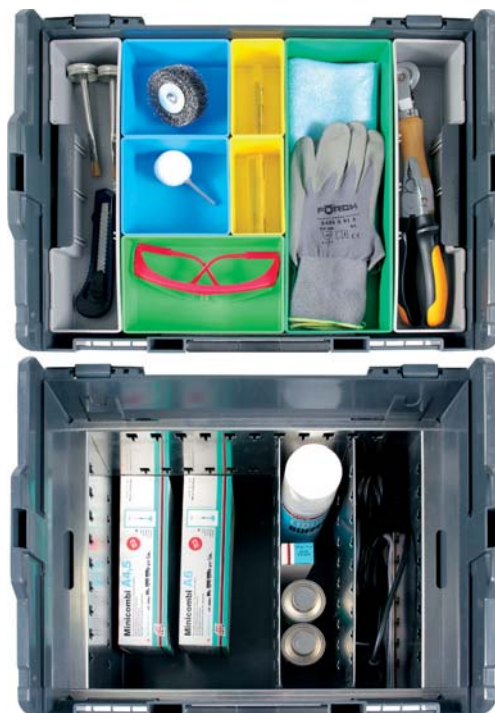

Article No.	Article Description	QTY
9003 3560	VAROBOXX TYR.M.REP.CASE4.5+6MM	1

Grinding Wheels GSV Alox / Flex **VAROBOXX**

- range in VAROBOXX 1
- with DL angle grinder

Contents

Article No.	Article Description	Quantity
5353 7107	MINI ANGLE GRIND.6MM INT.7107	1
5912 50 40	SOFT-FLEX 45'GSV 50 P40	4
5912 50 80	SOFT-FLEX 45'GSV 50 P80	4
5912 50 120	SOFT-FLEX 45'GSV 50 P120	4
5973 51 3	FLEECE COMP.DISC GSV 51 MEDIUM	3
5976 50	GSV HOLDER 6MM-SHAFT D50MM	1
5976 50 7	GSV NYLON ABRASIVE RED D50MM	2
5976 50 15	GSV FLEECE D50MM MEDIUM	5
5976 50 16	GSV FLEECE D50MM FINE	5
5976 50 17	GSV FLEECE D50MM VERY FINE	5
5976 50 36	GSV FIBRE DISC AL/OX D50MM P36	5
5976 50 60	GSV FIBRE DISC AL/OX D50MM P60	5
5976 50 80	GSV FIBRE DISC AL/OX D50MM P80	5
9003 1	VAROBOXX SIZE:1 EMPTY	1
9004 0 1	COVER INLAY VAROBOXX	1
9004 1 0	INSET BOX GREY SIDE.VAROBOXX 1	1
9004 1 0 1	DIVI.INSET BOX SIZE VAROBOXX 1	2
9004 1 5 10	INS.BOX YELL.5X10CM VAROBOXX 1	4
9004 1 10 10	INS.BOX BLUE 10X10CM VAROBOXX 1	4
9004 1 10 30	INSETB.D-GR.10X30CM VAROBOXX 1	1



Article No.	Article Description	QTY
9003 5976	VAROBOXX GRIND.WH.DL-WS GSV	1

Forming Gas Test Case, 9 Pieces **VAROBOXX**

- for detection with forming gas 95 / 5 (95% nitrogen, 5% hydrogen)
- the forming gas escapes at the unsealed spot and can be easily sniffed with the electronic leak detector included in this pack
- filling of the air conditioning unit with test gas possible either via the discharge side (e.g.at a service connections) or at both discharge sides at the same time and after one another
- simultaneous test pressure in the unit e.g. when the expansion valve is shut
- test gas bottle (nitrogen or forming gas) does not have to remain in the vehicle and may be separated from the filled unit. This enables further work to be carried out on other vehicles whilst autonomously and simultaneously testing the pressure loss on the first vehicle
- bottle manometer max. 20 bar
- 3-way valve with pressure manometer max. 34 bar
- the forming gas is not included in the delivery

Article No.	Article Description	QTY
9003 5380	VAROBOXX FORMING GAS TEST CASE	1

Contents:

- 1x Art. No. 5380 161: forming gas leak detection unit
- 1x Art. No. 5380 162: pressure regulator forming gas
- 1x Art. No. 5380 606: blue air conditioning hose 3 m, IG ¼" SAE
- 1x Art. No. 5380 690: service coupling ND blue AG ¼" SAE
- 1x Art. No. 5380 163: high pressure test armature 3-way valve
- 1x Art. No. 5380 604: blue air conditioning hose 90 cm IG ¼" SAE
- 1x Art. No. 5380 607: red air conditioning hose 3 m, IG ¼" SAE
- 1x Art. No. 5380 691: service coupling HD red AG ¼" SAE
- 1x Art. No. 9003 2: VAROBOXXGr. 2 empty



Pro Air-conditioning Repair Set, 81 Pieces

- For the line and hose repair of air-conditioning systems
- Thanks to the compact design, work is also possible in the confined space of an engine compartment
- Fittings are designed to handle pressure up to approx. 100 bar
- Repairs on air-conditioning systems may only be performed by specialist staff
- Observe legal regulations (Chemicals Climate Protection Ordinance)

Your Advantage / Benefit

- Suitable for air-conditioning systems with R134a, R1234yf and R12
- Professional repair by means of pressed connections
- Repair is possible without removing lines
- Hose to pipe connections can be repaired

Application

Line diameter conversion:

- 5/16" = 8 mm
- 3/8" = 10 mm
- 1/2" = 12 mm
- 5/8" = 16 mm
- 3/4" = 19 mm

The procedure is described in detail in the operating instructions.



Article No.	Article Description	Quantity
3102 4000	CLAMP,PLIERS F.PERFORATED CLIP	1
4628 19	FORKED RING-RATCHET SPANNER 19	1
4715 160	CALIPER 150MM	1
4750 2 3	PROFIGRAT SET TELE.W.BLADE7PCS	1
4941 3 30	COMPACT PIPE CUTTER 3-30 MM	1
5380 81 0	TOOL KIT FOR FITTING 11-PCE	1
5380 81 2	GRIND.FLEECE FOR PIPELINE	1
5380 81 12	PIPE-PIPE FITTING 1/2"	2
5380 81 12 1	PIPE-HOSE FITTING 1/2"	2
5380 81 12 1 1	PIPE-HOSE, MOUNTING FUSE 1/2"	2
5380 81 12 1 2	PCK(2)PIPE HOSE CLAMP 1/2"	2
5380 81 12 2	PCK(4)PIPELINE 1/ 2" X30.5CM	1
5380 81 34	PIPE-PIPE FITTING 3/4"	2
5380 81 34 1	PIPE HOSE FITTING 3/4"	2
5380 81 34 1 1	PIPE HOSE MOUNTING FUSE 3/4"	2
5380 81 34 1 2	PCK(2)PIPE HOSES CLAMP 3/4"	2
5380 81 34 2	PCK(4)PIPELINE 3/4" X30.5CM	1
5380 81 38	PIPE-PIPE FITTING 3/8"	2
5380 81 38 1	PIPE-HOSE FITTING 3/8"	2
5380 81 38 2	PCK(6)PIPELINE 3/ 8" X30.5CM	1

Article No.	Article Description	Quantity
5380 81 58	PIPE-PIPE FITTING 5/8"	2
5380 81 58 1	PIPE HOSE FITTING 5/8"	2
5380 81 58 1 1	PIPE-HOSE MOUNTING FUSE 5/8"	2
5380 81 58 1 2	PCK(2)PIPE HOSE CLAMP 5/8"	2
5380 81 58 2	PCK(4)PIPELINE 5/8" X30.5CM	1
5380 81 516	PIPE-PIPE FITTING 5/16"	2
5380 81 516 1	PIPE-PIPE FITTING 5/16"	2
5380 81 516 1 1	PIPE-HOSE, MOUNTING FUSE 5/16"	2
5380 81 516 1 2	PCK(2)PIPE-HOSE CLAMP 5/16"	2
5380 81 516 2	PCK(8)PIPELINE 5/16" X30.5CM	1
9003 1	VAROBOXX SIZE:1 EMPTY	2
9003 2	VAROBOXX SIZE:2 EMPTY	1
9004 0 1	COVER INLAY VAROBOXX	3
9004 1 0	INSET BOX GREY SIDE.VAROBOXX 1	1
9004 1 5 5	INSET BOX RED 5X5CM VAROBOXX1	6
9004 1 5 10	INS.BOX YELL.5X10CM VAROBOXX 1	13
9004 1 5 20	INS.BOX ORAN.5X20CM VAROBOXX 1	1
9004 2 7	DEEP DRAWN INS.4COMP.VAROBOXX2	1
9004 5380 81	AIR COND.REPKIT VAROBOXX1	1
9008 7	VAROBOXX WALL BRACKET	1

Article No.	Article Description	QTY
9003 5380 81	PRO AIR-COND.REPAIR SET 81-PCE	1

Pro Air-cond.Repair Set 81-PCE, Accessories

- the pipe-hose Fitting 3/8" (Art. No. 5380 81 38 1) can be applied with the pipe-hose-mounting fuse 5/16" (Art. No. 5380 81 516 1 1) and the pipe-hose-clamp 5/16"(Art. No. 5380 81 516 1 2)

Article No.	Article Description	QTY
5380 81 0	TOOL KIT FOR FITTING 11-PCE	1
5380 81 1 1	MAN.MOUNT.PLIERS FOR FITTING	1
5380 81 1 516	MOUNTING BRACKET 5/16"	1
5380 81 1 38	MOUNTING BRACKETS 3/8"	1
5380 81 1 12	MOUNTING BRACKETS 1/2"	1
5380 81 1 58	MOUNTING BRACKETS 5/8"	1
5380 81 1 34	MOUNTING BRACKETS 3/4"	1
5380 81 2	GRIND.FLEECE FOR PIPELINE	1
5380 81 516	PIPE-PIPE FITTING 5/16"	1
5380 81 38	PIPE-PIPE FITTING 3/8"	1
5380 81 12	PIPE-PIPE FITTING 1/2"	1
5380 81 58	PIPE-PIPE FITTING 5/8"	1
5380 81 34	PIPE-PIPE FITTING 3/4"	1
5380 81 516 1	PIPE-PIPE FITTING 5/16"	1
5380 81 516 1 1	PIPE-HOSE, MOUNTING FUSE 5/16	1
5380 81 516 1 2	PCK(2)PIPE-HOSE CLAMP 5/16	1
5380 81 38 1	PIPE-HOSE FITTING 3/8"	1
5380 81 12 1	PIPE-HOSE FITTING 1/2"	1
5380 81 12 1 1	PIPE-HOSE, MOUNTING FUSE 1/2"	1
5380 81 12 1 2	PCK(2)PIPE HOSE CLAMP 1/2"	1
5380 81 58 1	PIPE HOSE FITTING 5/8"	1
5380 81 58 1 1	PIPE-HOSE MOUNTING FUSE 5/8"	1
5380 81 58 1 2	PCK(2)PIPE HOSE CLAMP 5/8"	1
5380 81 34 1	PIPE HOSE FITTING 3/4"	1
5380 81 34 1 1	PIPE HOSE MOUNTING FUSE 3/4"	1
5380 81 34 1 2	PCK(2)PIPE HOSES CLAMP 3/4"	1
5380 81 516 2	PCK(8)PIPELINE 5/16" X30.5CM	1
5380 81 38 2	PCK(6)PIPELINE 3/ 8" X30.5CM	1
5380 81 12 2	PCK(4)PIPELINE 1/ 2" X30.5CM	1
5380 81 58 2	PCK(4)PIPELINE 5/8" X30.5CM	1
5380 81 34 2	PCK(4)PIPELINE 3/4" X30.5CM	1
4628 19	FORKED RING-RATCHET SPANNER 19	1
4750 2 3	PROFIGRAT SET TELE.W.BLADE7PCS	1
4941 3 30	COMPACT PIPE CUTTER 3-30 MM	1
3102 4000	CLAMP,PLIERS F.PERFORATED CLIP	1
4715 160	CALIPER 150MM	1

Contents Art. No. 5380 81 0:

- 1x Art. No. 5380 81 1 1: Manual mounting pliers
- 1x Art. No. 5380 81 1 516: Mounting brackets 5/16"
- 1x Art. No. 5380 81 1 38: Mounting brackets 3/8"
- 1x Art. No. 5380 81 1 12: Mounting brackets 1/2"
- 1x Art. No. 5380 81 1 58: Mounting brackets 5/8"
- 1x Art. No. 5380 81 1 34: Mounting brackets 3/4"



5380 81 1 1



5380 81 1 516
5380 81 1 38



5380 81 2



5380 81 516
5380 81 38
5380 81 12
5380 81 58
5380 81 34



5380 81 516 1
5380 81 38 1
5380 81 12 1
5380 81 58 1
5380 81 34 1



5380 81 516 1 1
5380 81 12 1 1
5380 81 58 1 1
5380 81 34 1 1



5380 81 516 1 2
5380 81 12 1 2
5380 81 58 1 2
5380 81 34 1 2



5380 81 516 2
5380 81 38 2
5380 81 12 2
5380 81 58 2
5380 81 34 2



4628 19



4715 160



3102 4000



4750 2 3



4941 3 30

Air-Conditioning Repair Set, 17 Parts

- For pipe diameters 8, 10, 12, 16 and 18 cm
- For hose diameters 8, 12, 16 and 18 cm
- Ideal for quick air-conditioning pipe and hose repair
- Repairs on air-conditioning systems may only be performed by special staff
- Adhere to legal regulations (Chemical Protection Ordinance)



Your Advantage / Benefit

- Suitable for air-conditioning with R134a, R1234yf and R12
- Cost-efficient repair
- Complete set with tools for line and hose repair
- No special installation tools
- Tight radii possible
- No bending of pipes necessary

Application

Caution: The procedure is described in detail in the operating instructions.

1. Empty the system as specified and search for the leak.
2. Establish access to the installation space (remove all the piping when required)
3. Measure the pipe or hose diameter (see whether repair with set is possible)
4. Choose repair version
 - 4.1 Air-conditioning pipe repair
 - Cut off and prepare pipe
 - Combine the repair hose with the connecting piece
 - Place the union nut with the cutting ring onto the air conditioning pipe
 - Assemble the Connection
 - 4.2 Air-conditioning hose repair
 - Cut off the hose (The cutting point should overlap with the leak.)
 - Place fitting and clamps between the hose ends
 - Crimp the connection
5. Check the vehicle for tightness and refill with cooling agent as prescribed.

Inhalt Stückliste

Article No.	Article Description	Quantity
4681 200	RABITZ PLIERS DIN 9242 200MM	1
4760 3 1	ALL-PURPOSE SCISSORS 215MM	1
4941 22	MINI-PIPE CUTTER 3-22MM	1
4941 100	INTERNAL/EXTERNAL CUTTER	1
5380 78 8	PIPE/HOSE CONNECTOR SET D.8MM	1
5380 78 8 0	HOSE FIT.CONNECTOR SET D.8MM	1
5380 78 8 1	COOL.AGENT HOSE I D.8MMX235MM	1
5380 78 10	PIPE/HOSE CONNECTOR SET D.10MM	1
5380 78 12	PIPE/HOSE CONNECTOR SET D.12MM	1
5380 78 12 0	HOSE-FIT.CONNECT.SET D. 12MM	1
5380 78 12 1	COOL.AGENT HOSE I D.10MMX235MM	1
5380 78 16	PIPE/HOSE CONNECTOR SET D.16MM	1
5380 78 16 0	HOSE FIT.CONNECTOR SET D.16MM	1
5380 78 16 1	COOL.AGENT HOSE I D.13MMX235MM	1
5380 78 18	PIPE/HOSE CONNECTOR SET D.18MM	1
5380 78 18 0	HOSE FIT.CONNECTOR SET D.18MM	1
5380 78 18 1	COOL.AGENT HOSE I D.16MMX235MM	1
9003 1	VAROBOXX SIZE:1 EMPTY	1
9004 0 1	COVER INLAY VAROBOXX	1
9004 1 0	INSET BOX GREY SIDE.VAROBOXX 1	2
9004 1 0 1	DIVI.INSET BOX SIZE VAROBOXX 1	1
9004 1 5 10	INS.BOX YELL.5X10CM VAROBOXX 1	9
9004 1 10 30	INSETB.D-GR.10X30CM VAROBOXX 1	1

Article No.	Article Description	QTY
9003 5380 78	AIR COND.PIPE REPAIR SET 17PCS	1

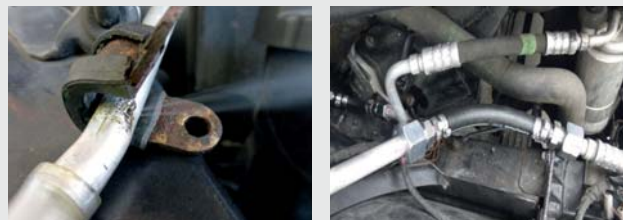

Related Products

- Forming Gas Test Case, 9-pce
Art. No. 9003 5380



- Air Conditioner Rinse Set
Art. No. 5380 701



- "Delta" Safety Glasses
Art. No. 5400 904 1



- Thermo-Chemical-Gloves PVC
Art. No. 5405 131 8 -10



Air-Conditioning Repair Set, 17 Parts, Accessories

Article No.	Article Description	QTY
5380 78 8	PIPE/HOSE CONNECTOR SET D.8MM	1
5380 78 8 0	HOSE FIT.CONNECTOR SET D.8MM	1
5380 78 8 1	COOL.AGENT HOSE I D.8MMX235MM	e 10
5380 78 10	PIPE/HOSE CONNECTOR SET D.10MM	1
5380 78 12	PIPE/HOSE CONNECTOR SET D.12MM	1
5380 78 12 0	HOSE-FIT.CONNECT.SET D. 12MM	1
5380 78 12 1	COOL.AGENT HOSE I D.10MMX235MM	e 10
5380 78 16	PIPE/HOSE CONNECTOR SET D.16MM	1
5380 78 16 0	HOSE FIT.CONNECTOR SET D.16MM	1
5380 78 16 1	COOL.AGENT HOSE I D.13MMX235MM	e 10
5380 78 18	PIPE/HOSE CONNECTOR SET D.18MM	1
5380 78 18 0	HOSE FIT.CONNECTOR SET D.18MM	1
5380 78 18 1	COOL.AGENT HOSE I D.16MMX235MM	e 10
4681 200	RABITZ PLIERS DIN 9242 200MM	1 s
4760 3 1	ALL-PURPOSE SCISSORS 215MM	1
4941 100	INTERNAL/EXTERNAL CUTTER	1
4941 22	MINI-PIPE CUTTER 3-22MM	1

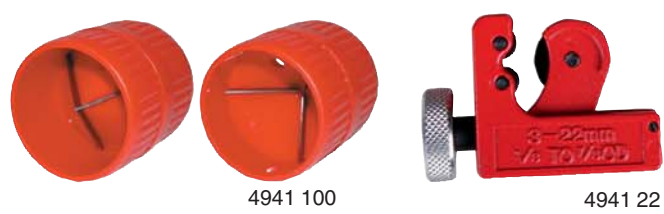
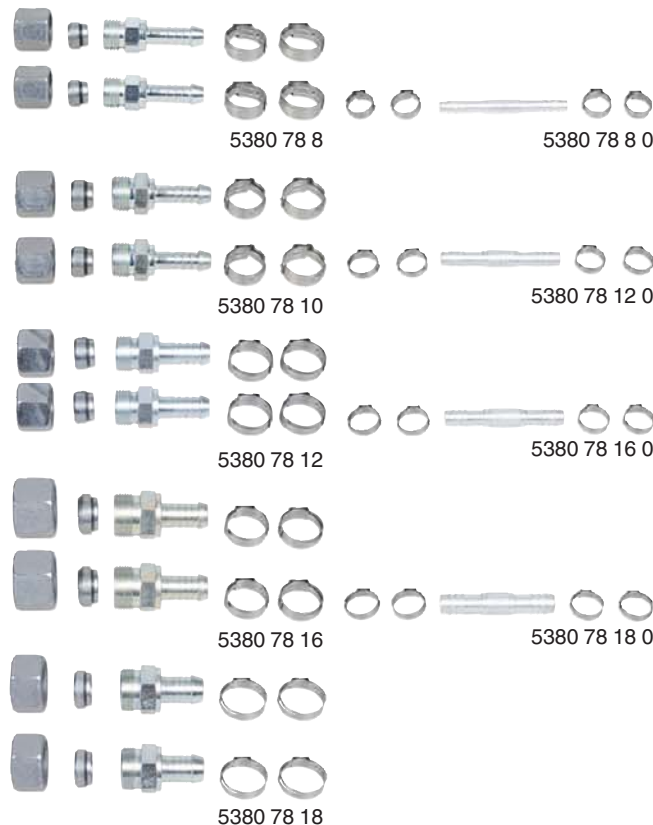

Radiator Hose Repair Kit, 129-Piece

- Assortment in VAROBOXX 1
- 129 parts
- Repair kit for rubber hosed in all common diameters (16, 20, 24, 25, 26 and 32 mm)
- The wide range of accessories makes quick and professional repair in all areas of the cooling water circuit possible
- With the supplied pieces of tubing also heavy damages can be handled by attaching a new piece of tubing

Application:

- Cut out the defective piece of tubing and repair using the supplied hose connector or connecting piece

Contents

Article No.	Article Description	Quantity
3200 12 20	HOSE CL TOR 9MM SW7 W2 12-22	4
3200 16 25	HOSE CL TOR 9MM SW7 W2 16-27	4
3200 23 35	HOSE CL TOR 9MM SW7 W2 23-35	4
3200 25 40	HOSE CL TOR 9MM SW7 W2 25-40	4
3919 050 20	BLIND PLUG	4
3919 051 20	SAFETY CLAMP	25
3919 052 20	O-RING 3.5X20MM	25
3919 150	RADIATOR HOSE GW Ø15MM L220MM	2
3919 200	RADIATOR HOSE GW Ø20MM L220MM	2
3919 250	RADIATOR HOSE GW Ø25MM L220MM	2
3919 320	RADIATOR HOSE GW Ø32MM L220MM	2
3919 885 19 8	T-HOSE CNCTR.RED.TYPE TRS 19/8	1
3919 900 4	HOSE CONNECTING PIECE GS4MM	2
3919 901 10	HOSE CONNECTING PIECE GS10MM	1
3919 902 12	HOSE CONNECTING PIECE GS12MM	1
3919 903 15	HOSE CONNECTING PIECE GS15MM	1
3919 904 19	HOSE CONNECTING PIECE GS19MM	1
3919 905 22	HOSE CONNECTING PIECE GS22MM	1
3919 911 10	L-HOSE CONNECT.PIECE LS 10	1
3919 912 12	L-HOSE CONNECT.PIECE LS 12	1
3919 913 15	L-HOSE CONNECT.PIECE LS 15	1
3919 914 19	L-HOSE CONNECT.PIECE LS 19	1
3919 920 10 12	REDUCING ADAPT.TYPE GRS 10/12	1
3919 921 12 15	REDUCING ADAPT.TYPE GRS 12/15	1
3919 922 15 19	REDUCING ADAPT.TYPE GRS 15/19	1
3919 928 4	T-HOSE CONNECT.PIECE TS 4	2
3919 929 6	T-HOSE CONNECT.PIECE TS 6	1
3919 930 8	T-HOSE CONNECT.PIECE TS 8	1
3919 931 10	T-HOSE CONNECT.PIECE TS 10	1
3919 932 12	T-HOSE CONNECT.PIECE TS 12	1
3919 933 15	T-HOSE CONNECT.PIECE TS 15	1
3919 934 19	T-HOSE CONNECT.PIECE TS 19	1
3919 935 12 8	T-HOSE CNCTR.REDUCE.TRS 12/8	1
3919 936 19 10	T-HOSE CNCTR.REDUCE.TRS 19/10	1
3919 941 25 20	T-HOSE CONNECTING PIECE 25/20	1
3919 942 32 20	T-HOSE CONNECTING PIECE 32/20	1
3919 943 38 20	T-HOSE CONNECTING PIECE 38/20	1
3919 946 20	CONNECTING PIECE FEMALE	1
3919 947 20	L-CONNECTNG PIECE FEMALE+MALE	1
3919 948 20	L-CONNECT.PIECE FEMALE+FEMALE	1
3919 949 20	CONNECTING PIECE MALE	1
3919 952 12	CONNECT.PIECE-HOSE CNCTR. 12MM	3
3919 953 15	CONNECT.PIECE-HOSE CNCTR. 15MM	3
3919 954 19	CONNECT.PIECE-HOSE CNCTR. 19MM	3
3919 955 22	CONNECT.PIECE-HOSE CNCTR. 22MM	3
3919 956 25	CONNECT.PIECE-HOSE CNCTR. 25MM	3
3919 957 32	CONNECT.PIECE-HOSE CNCTR. 32MM	3
9003 1	VAROBOXX SIZE:1 EMPTY	2
9004 0 1	COVER INLAY VAROBOXX	2
9004 1 0	INSET BOX GREY SIDE.VAROBOXX 1	2
9004 1 0 1	DIVI.INSET BOX SIZE VAROBOXX 1	1
9004 1 5 10	INS.BOX YELL.5X10CM VAROBOXX 1	25
9004 1 10 10	INS.BOX BLUE10X10CM VAROBOXX 1	3



Article No.	Article Description	QTY
3919 1	RADIATOR HOSE REPAIR KIT	1

Universal Clips **VAROBOXX**

- range in VAROBOXX 1
- 850 piece
- fasteners suitable for 80% of vehicles

Contents

Article No.	Article Description	Quantity
3040 1001	CLAMPING NUT PLAST.11.1X14.1	25
3040 1002	TURN LOCK PLAST. 6.4X14 B25	25
3040 1021	MOULDING CLIP WITH RED RING	25
3040 1025	INNER LINING CLIP YELLOW 1025	25
3040 1027	GEOMET CLAMPWASHER 321 SILVER	25
3040 1031	SHEET METAL SCREW 4.8X16 TX25	25
3040 1034	FIR TREE CLIP 20X2.5X20 1034	25
3040 1208	MOUNTING DOOR LINING 1208	50
3040 1228	FIR TREE CLIP BL 11X32X24 1228	50
3040 1245	MOULDING CLAMP LATERAL	25
3040 1272	EXPANDING RIVET 8X18X14 1272	10
3040 1544	EXPANDING RIVET 8X16X11 1544	25
3040 1839	SCREW 5X16 1839	25
3040 3001	EXPRIVET PLAST. 7.9X12.0 B16	25
3040 3002	EXPRIVET PLAST.5.8X11.4 B10	25
3040 3003	EXPRIVET PLAST.5.5X11.0 B16	25
3040 3007	EXPRIV. PLAST.7.8X11.0 B12.3	25
3040 3008	EXPRIVET PLAST.8.0X15.0 B19	25
3040 3009	EXPRIVET PLAST.8.0X15.0 B13	25
3040 3010	EXPRIV.W.CAP PLAST.6.5X20 B20	25
3040 3011	EXPRIV.W.CAP PLAST.6.5X17 B20	25
3040 3012	PLST.SPREAD NUT 7.4X6.6 3012	25
3040 3014	EXPRIVET PLAST. 5.0X11.5 B10	25
3040 3015	PLST.SPREAD NUT 7.0X7.0 3015	25
3040 3016	EXPRIV.W.CAP PLAST.6.5X15 B15	25
3040 3021	PLST.SPREAD NUT 7.0X7.0 3021	25
3040 3023	EXPRIV.W.CAP PLAST.8.7X14 B20	25
3040 3057	EXP.RIVET PLASTIC 6.4X14 B22	50
3040 3062	SCREW RIVET PLASTIC 8.2X18X14	50
3040 4003	PLASTIC RIVETS 6.3X25.2MM	20
3040 4005	PLASTIC RIVETS 6.0X19.3MM	20
9003 1	VAROBOXX SIZE:1 EMPTY	1
9004 0 1	COVER INLAY VAROBOXX	1
9004 1 0	INSET BOX GREY SIDE.VAROBOXX 1	2
9004 1 0 1	DIVI.INSET BOX SIZE VAROBOXX 1	4
9004 1 5 5	INSET BOX RED 5X5CM VAROBOXX1	20
9004 1 5 10	INS.BOX YELL.5X10CM VAROBOXX 1	5



Article No.	Article Description	QTY
9003 3040	VAROBOXX CLIPS UNIVERSAL	1

Blade Fuses and Joint Connector **VAROBOXX**

- Assortment in VAROBOXX 1
- 500 pieces

Contents

Article No.	Article Description	Quantity
3702 539	HS-SOLD.BUTT CNCTR BLUE 539	10
3702 541	HS-SOLD.BUTT CNCTR RED 541	10
3702 839	H SRNK BUTT CONNECT.BLUE 839	10
3702 841	H SRNK BUTT CONNECT.RED 841	10
3733 3	HEAT SHRINK TUBING IK 100MM3/1	10
3808 5	MINI BLADE FUSE 5A	25
3808 10	MINI BLADE FUSE 10A	25
3808 15	MINI BLADE FUSE 15A	25
3808 20	MINI BLADE FUSE 20A	25
3808 25	MINI BLADE FUSE 25A	25
3808 30	MINI BLADE FUSE 30A	25
3810 5	BLADE FUSE STD 5A	25
3810 10	BLADE FUSE STD 10A	25
3810 15	BLADE FUSE STD 15A	25
3810 20	BLADE FUSE STD 20A	25
3810 25	BLADE FUSE STD 25A	25
3810 30	BLADE FUSE STD 30A	25
3814 5	MICRO BLADE FUSE 5A	25
3814 10	MICRO BLADE FUSE 10A	25
3814 15	MICRO BLADE FUSE 15A	25
3814 20	MICRO BLADE FUSE 20A	25
3814 25	MICRO BLADE FUSE 25A	25
3814 30	MICRO BLADE FUSE 30A	25
9003 1	VAROBOXX SIZE:1 EMPTY	1
9004 0 1	COVER INLAY VAROBOXX	1
9004 1 25	INSET BOX SET YELLOW VAROBOXX1	1



Article No.	Article Description	QTY
9003 3808 3814	VAROBOXX BL.FUSES/JNT CONNECT.	1

Assorted Lashing Straps Lightweight 9-pce

VAROBOXX

- Product assortment in VAROBOXX 2
- Manufactured and tested in accordance with DIN EN 12195-2
- For securing light to medium weight items
- Claw hook

Contents

Article No.	Article Description	Quantity
4981 1000	RAT.STRAP500/1000KG POIN.H.6M	4
4981 2000 1	RAT.STRAP1000/2000KG POINT. 6M	4
9003 2	VAROBOXX SIZE:2 EMPTY	1

Article No.	Article Description	QTY
9003 4981 1	VAROBOXX LASH.STR.LIGHT WEIGHT	1



Assorted Lashing Straps Heavy Duty 9-pce

VAROBOXX

- Product assortment in VAROBOXX 4
- Manufactured and tested in accordance with DIN EN 12195-2
- For securing heavy items
- Claw hook

Contents

Article No.	Article Description	Quantity
4981N 4000 1	RA.STRAP 2-4T. POINT H. 8M ECO	4
4981N 5000 1	R.STRAP 2.5-5T.S.HO.8M ECO	4
9003 4	VAROBOXX SIZE:4 EMPTY	1

Article No.	Article Description	QTY
9003 4981 2	VAROBOXX LASH.STR.HEAVY DUTY	1



Load Securing Kit VAROBOXX

- Assortment in VAROBOXX 3
- Load securing kit for many applications
- For securing lightweight to medium-weight goods

Contents

Article No.	Article Description	Quantity
4762 18 3	CUTTERKNIFE 18MM	1
4980 250	LASH.STRAP 200/ 400KG 25MM 3M	2
4981 2000 1	RAT.STRAP1000/2000KG POINT. 6M	4
4984 3 600 150	ANTI-SKID MAT 600X150X3MM	10
4984 7 50 80	EDGE PROTECTION 50/80MM BLACK	10
4984 8 130 110	ANTI-SKID MAT 130X110X8MM	10
4984 8 300 200	ANTI-SKID MAT 300X200X8MM	6
4984 900	END FIT. F.AIRL.TRACK W.EYELET	5
9003 3	VAROBOXX SIZE:3 EMPTY	1

Article No.	Article Description	QTY
9003 498	VAROBOXX LOAD SECURING KIT	1



VAROIBOXX

- transparent lid for quick identification of contents
- strong design – high quality „Made in Germany“
- any division using inset boxes possible
- for division using inset boxes at least one grey inset box item no. 9008 75 260 is required
- optimally combined with VAROBOXX LS
- External dimensions (WxDxH): 367 × 316 × 72 mm
- internal dimensions (WxDxH): approx. 340 × 260 × 63 mm
- Max. load of each single box: 5 kg
- weight: 0.9 kg



Article No.	Article Description	QTY
9008 1	VAROIBOXX EMPTY	1

Drawer VAROBOXX LS

- stable high-quality „Made in Germany“ design
- any division using inset box possible
- for division with inset boxes at least one grey inset box item no. 9008 75 260 is required
- optimally combined with VAROBOXX LS
- external dimensions (W × D × H): 367 × 316 × 72 mm
- Internal dimensions (W × D × H): 353 × 268 × 70 mm
- Max. load of the drawer: 5 kg
- weight approx.: 550 g



Article No.	Article Description	QTY
9003 5 1	VAROBOXX LS/RACK DRAWER	1

Rack, Block of 3 **VAROiBOXX**

- compatible with all VAROBOXSES
- click system in bottom segment, other segments separable using a screwdriver
- individual segment easily extendable with rack
- drawer suitable for VAROBOXX or VAROBOXX LS drawer
- made from shock and impact resistant ABS plastic
- may also be used as a vehicle or workshop shelf
- outer dimension (W x D x H): 442 x 337 x 307 mm
- weight: 3.70 kg

Article No.	Article Description	QTY
9008 3	VAROiBOXX RACK BLOCK OF 3	1



Rack, Block of 5 **VAROiBOXX**

- compatible with all VAROBOXSES
- click system in bottom segment, other segments separable using a screwdriver
- individual segment easily extendable with rack
- drawer suitable for VAROBOXX or VAROBOXX LS drawer
- made from shock and impact resistant ABS plastic
- may also be used as a vehicle or workshop shelf
- outer dimension (W x D x H): 442 x 337 x 475 mm
- weight: 5.75 kg

Article No.	Article Description	QTY
9008 5	VAROiBOXX RACK BLOCK OF 5	1



Rack, Individual Segment **VAROiBOXX**

- compatible with all VAROBOXSES
- click system
- expandable
- insertion compartment suitable for VAROiBOXX or VAROBOXX LS drawer
- made from shock and impact-resistant ABS plastic
- can also be used as a vehicle or workshop shelf
- External dimensions (WxDxH): 442 × 340 × 100 mm
- Weight: 0.98 kg



Article No.	Article Description	QTY
9008 4	VAROiBOXX RACK INDIV.SEGMENT	1

Rack, Lid **VAROiBOXX**

- for VAROBOXX rack individual segment
- made from shock and impact-resistant ABS plastic
- external dimensions (WxDxH): 442 × 340 × 100 mm
- Weight: 0.88 kg



Article No.	Article Description	QTY
9008 6	VAROiBOXX RACK LID	1

Wall Bracket, **VAROiBOXX**

- Suitable for securing the VAROiBOXX to walls or inside vehicles
- Ideal in conjunction with the VAROiBOXX first aid boxes Art. no. 9007 13157 and 9007 13169
- Made from ABS plastic
- Dimensions: 325 × 355 × 47 mm
- Weight: 0.394 kg

Art. No. 9008 7 2:

- Mounting set suitable for the VAROMOBIL module



Article No.	Article Description	QTY
9008 7	VAROiBOXX WALL BRACKET	1
9008 7 2	VAROiBOXX MOUNT.SET WALL BRACK	1

Thermoformed Insert, 4 Compartments, **VAROiBOXX**

- Tray for small parts made from deep-drawn plastic
- With 4 compartments (4 compartments 156 × 115 mm)
- Cost-effective way to organise the VAROiBOXX
- Suitable for VAROiBOXX and the VAROBOXX LS drawer

Article No.	Article Description	QTY
9008 1 4	VAROiBOXX THERMOF.INS.4COMP.	1



Thermoformed Insert, 7 Compartments, **VAROiBOXX**

- Tray for small parts made from deep-drawn plastic
- With 7 compartments
- Cost-effective way to organise the VAROiBOXX
- Suitable for VAROiBOXX and VAROBOXX LS drawer

Article No.	Article Description	QTY
9008 1 7	VAROiBOXX THERMOF.INS.7COMP.	1



Thermoformed Insert, 8 Compartments, **VAROiBOXX**

- Tray for small parts made from deep-drawn plastic
- With 8 compartments (8 compartments 118 × 76,5 mm)
- Cost-effective way to organise the VAROiBOXX
- Suitable for VAROiBOXX and the VAROBOXX LS drawer

Article No.	Article Description	QTY
9008 1 8	VAROiBOXX THERMOF.INS.8COMP.	1



Thermoformed Insert, 9 Compartments, **VAROiBOXX**

- Tray for small parts made from deep-drawn plastic
- With 9 compartments (4 compartments 324 × 32 mm / 4 compartments 230 × 18 mm / 1 compartment 90 × 88 mm)
- Cost-effective way to organise the VAROiBOXX
- Suitable for VAROiBOXX and the VAROBOXX LS drawer

Article No.	Article Description	QTY
9008 1 9	VAROiBOXX THERMOF.INS.9COMP.	1



Thermoformed Insert, 12 Compartments, **VAROiBOXX**

- Tray for small parts made from deep-drawn plastic
- With 12 compartments (12 compartments 77 × 77 mm)
- Cost-effective way to organise the VAROiBOXX
- Suitable for VAROiBOXX and the VAROBOXX LS drawer

Article No.	Article Description	QTY
9008 1 12	VAROiBOXX THERMOF.INS.12COMP.	1



Thermoformed Insert, 14 Compartments, **VAROiBOXX**

- Tray for small parts made from deep-drawn plastic
- With 14 compartments (12 compartments 67 × 49 mm / 1 compartment 92 × 32 mm / 1 compartment 280 × 92 mm)
- Cost-effective way to organise the VAROiBOXX
- Suitable for VAROiBOXX and the VAROBOXX LS drawer

Article No.	Article Description	QTY
9008 1 14	VAROiBOXX THERMOF.INS.14COMP.	1



Thermoformed Insert, 16 Compartments, **VAROiBOXX**

- Tray for small parts made from deep-draw formed plastic
- With 16 compartments
- Cost-effective way to organise the VAROiBOXX
- Suitable for VAROiBOXX and the VAROBOXX LS drawer

Article No.	Article Description	QTY
9008 1 16	VAROiBOXX THERMOF.INS.16COMP.	1



Thermoformed Insert, 18 Compartments, **VAROiBOXX**

- Tray for small parts made from deep-drawn plastic
- With 18 compartments (18 compartments 71 × 43 mm)
- Cost-effective way to organise the VAROiBOXX
- Suitable for VAROiBOXX and the VAROBOXX LS drawer

Article No.	Article Description	QTY
9008 1 18	VAROiBOXX THERMOF.INS.18COMP.	1



Thermoformed Insert, 20 Compartments, **VAROiBOXX**

- Tray for small parts made from deep-drawn plastic
- With 20 compartments (each 2 compartments 169.75 / 157.75 / 145.75 / 133.75 / 121.75 / 109.75 / 97.45 / 85.75 / 72.45 / 64.93 x 26.80 mm)
- Cost-effective way to organise the VAROiBOXX
- Suitable for VAROiBOXX and the VAROBOXX LS drawer



Article No.	Article Description	QTY
9008 1 20	VAROiBOXX THERMOF.INS.20COMP.	1

Inset Box, Grey **VAROiBOXX**

- Type I3
- Dimensions (W x D x H): 260 x 78 x 63 mm
- suitable for VAROiBOXX



Article No.	Article Description	QTY
9008 75 260	VAROiBOXX INSET.B.GREY7.5X26MM	1

Partition Inset Box, Grey **VAROiBOXX**

- Type I3
- suitable for VAROiBOXX



Article No.	Article Description	QTY
9008 75 260 1	PART.INSERT BOX GREY VARIOBOXX	1

Inset Box Set, Red **VAROiBOXX**

Article No.	Article Description	QTY
9008 2 28	INSET BOX RED VARIOBOXX	1

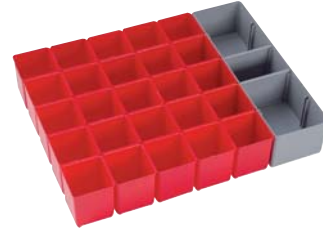

Inset Box Set, Yellow/Red **VAROiBOXX**

Article No.	Article Description	QTY
9008 2 16	INSET BOX YELL/RD VARIOBOXX	1

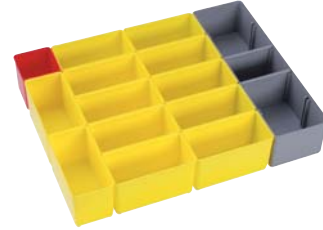

Inset Box Set, Blue/Yellow/Red **VAROiBOXX**

Article No.	Article Description	QTY
9008 2 14	INSET BOX BU/YE/RD VARIOBOXX	1



Inset Box Set, Grey/Yellow/Red **VAROiBOXX**

Article No.	Article Description	QTY
9008 2 17	INSET BOX GN/YE/RD VARIOBOXX	1

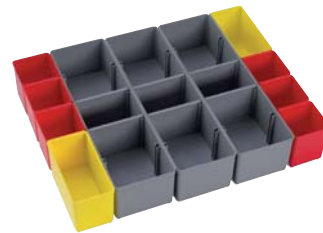

Inset Box Set, All Colours **VAROiBOXX**

Article No.	Article Description	QTY
9008 2 12	INSET BOX ALL COLOU.VARIOBOXX	1



Hexagon Head Bolts DIN 931, 8.8 GV **VAROiBOXX**

- 290 pieces
- Complies with ISO 4014
- with shank
- Strength class 8.8
- **Galvanised steel**

Contents

Article No.	Article Description	Quantity
1001 6 30	HEX HD BOLT 931 8.8 GA 6X 30	50
1001 6 40	HEX HD BOLT 931 8.8 GA 6X 40	50
1001 6 50	HEX HD BOLT 931 8.8 GA 6X 50	20
1001 6 60	HEX HD BOLT 931 8.8 GA 6X 60	20
1001 8 35	HEX HD BOLT 931 8.8 GA 8X 35	20
1001 8 40	HEX HD BOLT 931 8.8 GA 8X 40	20
1001 8 50	HEX HD BOLT 931 8.8 GA 8X 50	20
1001 8 60	HEX HD BOLT 931 8.8 GA 8X 60	20
1001 10 40	HEX HD BOLT 931 8.8 GA 10X 40	20
1001 10 45	HEX HD BOLT 931 8.8 GA 10X 45	20
1001 10 50	HEX HD BOLT 931 8.8 GA 10X 50	20
1001 10 60	HEX HD BOLT 931 8.8 GA 10X 60	10
9008 1	VAROiBOXX EMPTY	1
9008 1 12	VAROiBOXX THERMOF.INS.12COMP.	1

Article No.	Article Description	QTY
9007 1001	VAROiBOXX HEX HD BOLT931 8.8GV	1



Hexagon Head Bolts DIN 933 8.8, GV **VAROiBOXX**

- 350 pieces
- Complies with ISO 4017
- With thread to head
- Strength class 8.8
- **Galvanised steel**

Contents

Article No.	Article Description	Quantity
1011 6 16	HEX HD M.SCREW933 8.8 GA 6X 16	50
1011 6 20	HEX HD M.SCREW933 8.8 GA 6X 20	50
1011 6 25	HEX HD M.SCREW933 8.8 GA 6X 25	25
1011 6 30	HEX HD SCR. 933 8.8 GA 6X 30	25
1011 8 16	HEX HD SCR. 933 8.8 GA 8X 16	50
1011 8 20	HEX HD SCREW933 8.8 GA 8X 20	50
1011 8 25	HEX HD M.SCREW933 8.8 GA 8X 25	25
1011 8 40	HEX HD M.SCREW933 8.8 GA 8X 40	20
1011 10 20	HEX HD SCR. 933 8.8 GA 10X 20	20
1011 10 25	HEX HD M.SCREW933 8.8 GA 10X25	20
1011 10 30	HEX HD M.SCREW933 8.8 GA 10X30	20
1011 10 40	HEX HD M.SCREW933 8.8 GA 10X40	20
9008 1	VAROiBOXX EMPTY	1
9008 1 12	VAROiBOXX THERMOF.INS.12COMP.	1



Article No.	Article Description	QTY
9007 1011	VAROiBOXX HEX HD BOLT933 8.8GV	1

Hexagon Head Bolts DIN 933, **Stainl.St.A2 VAROiBOXX**

- 380 pieces
- Complies with ISO 4017
- **Stainless steel A2**

Contents

Article No.	Article Description	Quantity
1015 6 16	HEX HD SCR. 933 A2 6X 16	50
1015 6 20	HEX HD SCR. 933 A2 6X 20	50
1015 6 25	HEX HD SCR. 933 A2 6X 25	25
1015 6 30	HEX HD SCR. 933 A2 6X 30	25
1015 8 16	HEX HD SCR. 933 A2 8X 16	50
1015 8 20	HEX HD SCR. 933 A2 8X 20	50
1015 8 25	HEX HD SCR. 933 A2 8X 25	25
1015 8 40	HEX HD SCR. 933 A2 8X 40	25
1015 10 20	HEX HD SCR. 933 A2 10X 20	20
1015 10 25	HEX HD SCR. 933 A2 10X 25	20
1015 10 30	HEX HD SCR. 933 A2 10X 30	20
1015 10 40	HEX HD SCR. 933 A2 10X 40	20
9008 1	VAROiBOXX EMPTY	1
9008 1 12	VAROiBOXX THERMOF.INS.12COMP.	1



Article No.	Article Description	QTY
9007 1015	VAROiBOXX HEX HD BOLT 933 A2	1

Screws / Nuts / Washers, GA **VARO iBOXX**

- 1,210 pieces
- Zinc-plated steel

Contents

Article No.	Article Description	Quantity
1011 6 20	HEX HD M.SCREW933 8.8 GA 6X 20	50
1011 6 50	HEX HD SCR. 933 8.8 GA 6X 50	50
1011 8 20	HEX HD SCREW933 8.8 GA 8X 20	50
1011 8 50	HEX HD M.SCREW933 8.8 GA 8X 50	20
1011 10 25	HEX HD M.SCREW933 8.8 GA 10X25	20
1011 10 50	HEX HD M.SCREW933 8.8 GA 10X50	20
2001 6	HEX NUT 934-8 GA 6	300
2001 8	HEX NUT 934-8 GA 8	150
2001 10	HEX NUT 934-8 GA 10	50
2301 6	WASHER 125 A GA 6	300
2301 8	WASHER 125 A GA 8	150
2301 10	WASHER 125 A GA 10	50
9008 1	VAROIBOXX EMPTY	1
9008 1 12	VAROIBOXX THERMOF.INS.12COMP.	1



Article No.	Article Description	QTY
9007 1	VAROIBOXX SCR./NUTS/WASHERS GA	1

Hex Socket Cap Screws DIN 912 8.8, GV

VAROIBOXX

- 310 pieces
- Complies with ISO 4762
- With socket head
- Strength class 8.8
- Galvanised steel

Contents

Article No.	Article Description	Quantity
1151 6 16	HEX SO. CAP 912 8.8 ZI 6X16	50
1151 6 20	HEX SO. CAP 912 8.8 ZI 6X20	50
1151 6 25	HEX SO. CAP 912 8.8 ZI 6X25	25
1151 6 30	HEX SO. CAP 912 8.8 ZI 6X30	25
1151 8 16	HEX SO. CAP 912 8.8 ZI 8X16	25
1151 8 20	HEX SO. CAP 912 8.8 ZI 8X20	25
1151 8 25	HEX SO. CAP 912 8.8 ZI 8X25	25
1151 8 40	HEX SO. CAP 912 8.8 ZI 8X40	25
1151 10 20	HEX SO. CAP 912 8.8 ZI 10X20	25
1151 10 25	HEX SO. CAP 912 8.8 ZI 10X25	20
1151 10 30	HEX SO. CAP 912 8.8 ZI 10X30	20
1151 10 40	HEX SO. CAP 912 8.8 ZI 10X40	20
9008 1	VAROIBOXX EMPTY	1
9008 1 12	VAROIBOXX THERMOF.INS.12COMP.	1

Article No.	Article Description	QTY
9007 1151	VAROIBOXX HEX SO.C.SC912 8.8GV	1



Hex Socket Cap Screws DIN 912, A2 VAROIBOXX

- 330 parts
- Complies with ISO 4762
- Stainless steel A2

Contents

Article No.	Article Description	Quantity
1155 6 16	HEX SO. CAP 912 A2 6X16	50
1155 6 20	HEX SO. CAP 912 A2 6X20	25
1155 6 25	HEX SO. CAP 912 A2 6X25	25
1155 6 30	HEX SO. CAP 912 A2 6X30	25
1155 8 16	HEX SO. CAP 912 A2 8X16	50
1155 8 20	HEX SO. CAP 912 A2 8X20	25
1155 8 25	HEX SO. CAP 912 A2 8X25	25
1155 8 40	HEX SO. CAP 912 A2 8X40	20
1155 10 20	HEX SO. CAP 912 A2 10X20	25
1155 10 25	HEX SO. CAP 912 A2 10X25	20
1155 10 30	HEX SO. CAP 912 A2 10X30	20
1155 10 40	HEX SO. CAP 912 A2 10X40	20
9008 1	VAROIBOXX EMPTY	1
9008 1 12	VAROIBOXX THERMOF.INS.12COMP.	1

Article No.	Article Description	QTY
9007 1155	VAROIBOXX HEX SO.CAP SC 912 A2	1



Hex Socket CSK CAP Screws DIN7991 8.8

GV VAROIBOXX

- 450 parts
- Complies with ISO 10462
- With countersunk head
- Strength class 8.8
- Galvanised steel

Contents

Article No.	Article Description	Quantity
1161 6 16	HEX SO. COUNT 7991 8.8ZP 6X16	50
1161 6 20	HEX SO. COUNT 7991 8.8ZP 6X20	50
1161 6 25	HEX SO. COUNT 7991 8.8ZP 6X25	50
1161 6 30	HEX SO. COUNT 7991 8.8ZP 6X30	25
1161 8 16	HEX SO. COUNT 7991 8.8ZP 8X16	50
1161 8 20	HEX SO. COUNT 7991 8.8ZP 8X20	50
1161 8 25	HEX SO. COUNT 7991 8.8ZP 8X25	50
1161 8 40	HEX SO. COUNT 7991 8.8ZP 8X40	25
1161 10 20	HEX SO. COUNT 7991 8.8ZP 10X20	25
1161 10 25	HEX SO. COUNT 7991 8.8ZP 10X25	25
1161 10 30	HEX SO. COUNT 7991 8.8ZP 10X30	25
1161 10 40	HEX SO. COUNT 7991 8.8ZP 10X40	25
9008 1	VAROIBOXX EMPTY	1
9008 1 12	VAROIBOXX THERMOF.INS.12COMP.	1



Article No.	Article Description	QTY
9007 1161	VAROIBOXX HEX SO.CAP.SC7991 GV	1

Countersunk Head Screws DIN 965, GV VAROIBOXX

- 1.000 parts
- Complies with ISO 7046
- With PH pan head
- Strength class 4.8
- Galvanised steel

Contents

Article No.	Article Description	Quantity
1241 4 10	PH COUNT HD SCR. 965 ZP 4X10	100
1241 4 16	PH COUNT HD SCR. 965 ZP 4X16	100
1241 4 20	PH COUNT HD SCR. 965 ZP 4X20	100
1241 4 30	PH COUNT HD SCR. 965 ZP 4X30	100
1241 5 10	PH COUNT HD SCR. 965 ZP 5X10	100
1241 5 16	PH COUNT HD SCR. 965 ZP 5X16	100
1241 5 20	PH COUNT HD SCR. 965 ZP 5X20	100
1241 5 30	PH COUNT HD SCR. 965 ZP 5X30	50
1241 6 10	PH COUNT HD SCR. 965 ZP 6X10	100
1241 6 16	PH COUNT HD SCR. 965 ZP 6X16	50
1241 6 20	PH COUNT HD SCR. 965 ZP 6X20	50
1241 6 25	PH COUNT HD SCR. 965 ZP 6X25	50
9008 1	VAROIBOXX EMPTY	1
9008 1 12	VAROIBOXX THERMOF.INS.12COMP.	1



Article No.	Article Description	QTY
9007 1241	VAROIBOXX PH COUNT HD SC 965GV	1

Self-Tapping Screws DIN 7981/7983, GV **VAROiBOXX**

- 1.600 parts
- Complies with ISO 7049
- with PH pan head
- Case-hardened
- **Galvanised steel**

Contents

Article No.	Article Description	Quantity
1311 35 95	SELF-TAP.SCREW 7981 GA 3.5X9.5	100
1311 35 13	SELF-TAP.SCREW 7981 GA 3.5X 13	100
1311 35 16	SELF-TAP.SCREW 7981 GA 3.5X 16	100
1311 35 19	SELF-TAP.SCREW 7981 GA 3.5X 19	100
1311 42 13	SELF-TAP.SCREW 7981 GA 4.2X 13	100
1311 42 16	SELF-TAP.SCREW 7981 GA 4.2X 16	100
1311 42 19	SELF-TAP.SCREW 7981 GA 4.2X 19	100
1311 42 22	SELF-TAP.SCREW 7981 GA 4.2X 22	50
1311 48 13	OV.PH SH.MET.SCR.7981 GA4.8X13	100
1311 48 16	OV.PH SH.MET.SCR.7981 GA4.8X16	100
1311 48 19	OV.PH SH.MET.SCR.7981 GA4.8X19	100
1311 48 22	OV.PH SH.MET.SCR.7981 GA4.8X22	50
1331 35 16	PH RSD CSK TAP.7983 GA 3.5X16	100
1331 35 19	PH RSD CSK TAP.7983 GA 3.5X19	100
1331 42 16	OV.PH SH.MET.SCR.7983 GA4.2X16	100
1331 42 22	OV.PH SH.MET.SCR.7983 GA4.2X22	50
1331 48 19	OV.PH SH.MET.SCR.7983 GA4.8X19	100
1331 48 22	OV.PH SH.MET.SCR.7983 GA4.8X22	50
9008 1	VAROiBOXX EMPTY	1
9008 1 18	VAROiBOXX THERMOF.INS.18COMP.	1



Article No.	Article Description	QTY
9007 131	VAROiBOXX SELF-T.SCR7981/83 GV	1

Self-Tapping Screws DIN 7981 GV **VARO**iBOXX

- 1,700 parts
- Complies with ISO 7049
- With PH pan head
- Case hardened
- **Galvanised Steel**

Contents

Article No.	Article Description	Quantity
1311 29 95	SELF-TAP.SCREW 7981 GA 2.9X9.5	100
1311 29 13	PH PANHD TAPSCR 7981GA 2.9X 13	100
1311 35 95	SELF-TAP.SCREW 7981 GA 3.5X9.5	100
1311 35 13	SELF-TAP.SCREW 7981 GA 3.5X 13	100
1311 35 16	SELF-TAP.SCREW 7981 GA 3.5X 16	100
1311 35 19	SELF-TAP.SCREW 7981 GA 3.5X 19	100
1311 39 13	SELF-TAP.SCREW 7981 GA 3.9X 13	100
1311 39 16	SELF-TAP.SCREW 7981 GA 3.9X 16	100
1311 39 19	OV.PH SH.MET.SCR.7981 GA3.9X19	100
1311 39 22	SELF-TAP.SCREW 7981 GA 3.9X 22	100
1311 42 13	SELF-TAP.SCREW 7981 GA 4.2X 13	100
1311 42 16	SELF-TAP.SCREW 7981 GA 4.2X 16	100
1311 42 19	SELF-TAP.SCREW 7981 GA 4.2X 19	100
1311 42 25	SELF-TAP.SCREW 7981 GA 4.2X 25	50
1311 48 13	OV.PH SH.MET.SCR.7981 GA4.8X13	100
1311 48 16	OV.PH SH.MET.SCR.7981 GA4.8X16	100
1311 48 19	OV.PH SH.MET.SCR.7981 GA4.8X19	100
1311 48 25	PH PANHD TAPSCR 7981GA 4.8X 25	50
9008 1	VAROIBOXX EMPTY	1
9008 1 18	VAROIBOXX THERMOF.INS.18COMP.	1



Article No.	Article Description	QTY
9007 1311	VAROIBOXX PH PANHD S.T.7981 GV	1

Self-Tapping Screws TX DIN 7981,GV **VARO**iBOXX

- 1,700 parts
- Complies with ISO 14585
- Drive: TX
- Case hardened
- **Galvanised steel**

Contents

Article No.	Article Description	Quantity
1312 29 95	LH-TX10 SCR.7981 GALV.2.9X9.5	100
1312 29 13	LH-TX10 SCR.7981 GALV.2.9X 13	100
1312 35 95	LH-TX15 SCR.7981 GALV.3.5X9.5	100
1312 35 13	LH-TX15 SCR.7981 GALV.3.5X 13	100
1312 35 16	LH-TX15 SCR.7981 GALV.3.5X 16	100
1312 35 19	LH-TX15 SCR.7981 GALV.3.5X 19	100
1312 39 13	LH-TX20 SCR.7981 GALV.3.9X 13	100
1312 39 16	LH-TX20 SCR.7981 GALV.3.9X 16	100
1312 39 19	LH-TX20 SCR.7981 GALV.3.9X 19	100
1312 39 22	LH-TX20 SCR.7981 GALV.3.9X 22	100
1312 42 13	LH-TX20 SCR.7981 GALV.4.2X 13	100
1312 42 16	LH-TX20 SCR.7981 GALV.4.2X 16	100
1312 42 19	LH-TX20 SCR.7981 GALV.4.2X 19	100
1312 42 25	LH-TX20 SCR.7981 GALV.4.2X 25	50
1312 48 13	LH-TX25 SCR.7981 GALV.4.8X13	100
1312 48 16	LH-TX25 SCR.7981 GALV.4.8X16	100
1312 48 19	LH-TX25 SCR.7981 GALV.4.8X19	100
1312 48 25	LH-TX25 SCR.7981 GALV.4.8X25	50
9008 1	VAROIBOXX EMPTY	1
9008 1 18	VAROIBOXX THERMOF.INS.18COMP.	1



Article No.	Article Description	QTY
9007 1312	VAROIBOXX LH TX S.T.SCR.7981GV	1

Self-Tapp.PanHead Scr.7981 DIN7981,C,A2

VAROIBOXX

- 950 parts
- Countersunk pan head
- Complies with ISO 7049
- PH pan head
- Design C with pointed tip
- **Stainless steel A2**

Contents

Article No.	Article Description	Quantity
1315 39 13	PH PAN HD SCR 7981 A2 3.9X13	100
1315 39 16	PH PAN HD SCR 7981 A2 3.9X16	100
1315 39 19	PH PAN HD SCR 7981 A2 3.9X19	100
1315 39 22	PH PAN HD SCR 7981 A2 3.9X22	100
1315 42 13	PH PAN HD SCR 7981 A2 4.2X13	100
1315 42 16	PH PAN HD SCR 7981 A2 4.2X16	100
1315 42 19	PH PAN HD SCR 7981 A2 4.2X19	100
1315 42 22	PH PAN HD SCR 7981 A2 4.2X22	50
1315 48 13	PH PAN HD SCR 7981 A2 4.8X13	50
1315 48 16	PH PAN HD SCR 7981 A2 4.8X16	50
1315 48 19	PH PAN HD SCR 7981 A2 4.8X19	50
1315 48 22	PH PAN HD SCR 7981 A2 4.8X22	50
9008 1	VAROIBOXX EMPTY	1
9008 1 12	VAROIBOXX THERMOF.INS.12COMP.	1

Article No.	Article Description	QTY
9007 1315	VAROIBOXX PH PANH.S.T.S.7981A2	1



Washer Hd.Self-Drill.Screws 7504 K, GV

VAROIBOXX

- 1,000 parts
- Hexagon head
- Galvanised steel

Contents

Article No.	Article Description	Quantity
1350 42 13	HEX SD SCR. 7504K ZP 4.2X13	100
1350 42 16	HEX SD SCR. 7504K ZP 4.2X16	100
1350 42 19	HEX SD SCR. 7504K ZP 4.2X19	100
1350 48 16	HEX SD SCR. 7504K ZP 4.8X16	100
1350 48 19	HEX SD SCR. 7504K ZP 4.8X19	100
1350 48 25	HEX SD SCR. 7504K ZP 4.8X25	100
1350 55 19	HEX SD SCR. 7504K ZP 5.5X19	100
1350 55 25	HEX SD SCR. 7504K ZP 5.5X25	100
1350 55 32	HEX SD SCR. 7504K ZP 5.5X32	50
1350 63 19	HEX SD SCR. 7504K ZP 6.3X19	50
1350 63 25	HEX SD SCR. 7504K ZP 6.3X25	50
1350 63 32	HEX SD SCR. 7504K ZP 6.3X32	50
9008 1	VAROIBOXX EMPTY	1
9008 1 12	VAROIBOXX THERMOF.INS.12COMP.	1

Article No.	Article Description	QTY
9007 1350	VAROIBOXX HX SD SCR.7504K GV	1



Pan HD Self-Drill. Scr.7504 N(M),GV **VARO iBOXX**

- 1,200 parts
- Pan head
- Galvanised steel

Contents

Article No.	Article Description	Quantity
1351 35 95	PAN HD SD SCR. 7504M GA3.5X9.5	100
1351 35 16	PAN HD SD SCR. 7504M GA 3.5X16	100
1351 35 19	PAN HD SD SCR. 7504M GA 3.5X19	100
1351 39 13	PAN HD SD SCR. 7504M GA 3.9X13	100
1351 39 16	PAN HD SD SCR. 7504M GA 3.9X16	100
1351 39 19	PAN HD SD SCR. 7504M GA 3.9X19	100
1351 42 13	PAN HD SD SCR. 7504M GA 4.2X13	100
1351 42 16	PAN HD SD SCR. 7504M GA 4.2X16	100
1351 42 19	PAN HD SD SCR. 7504M GA 4.2X19	100
1351 42 25	PAN HD SD SCR. 7504M GA 4.2X25	100
1351 48 16	PAN HD SD SCR. 7504M GA 4.8X16	100
1351 48 19	PAN HD SD SCR. 7504M GA 4.8X19	100
9008 1	VAROIBOXX EMPTY	1
9008 1 12	VAROIBOXX THERMOF.INS.12COMP.	1

Article No.	Article Description	QTY
9007 1351	VAROIBOXX PANHD SD SC.7504M GV	1



Self-Drill.Scr.w.CSK HD 7504P(O),GV **VARO iBOXX**

- 1,200 pieces
- Hexagonal
- Galvanised steel

Contents

Article No.	Article Description	Quantity
1352 35 13	PH CSK SD SCR.7504-O ZP 3.5X13	100
1352 35 16	PH CSK SD SCR.7504-O ZP 3.5X16	100
1352 35 19	PH CSK SD SCR.7504-O ZP 3.5X19	100
1352 39 13	PH CSK SD SCR.7504-O ZP 3.9X13	100
1352 39 16	PH CSK SD SCR.7504-O ZP 3.9X16	100
1352 39 19	PH CSK SD SCR.7504-O ZP 3.9X19	100
1352 42 16	PH CSK SD SCR.7504-O ZP 4.2X16	100
1352 42 19	PH CSK SD SCR.7504-O ZP 4.2X19	100
1352 42 22	PH CSK SD SCR.7504-O ZP 4.2X22	100
1352 48 19	PH CSK SD SCR.7504-O ZP 4.8X19	100
1352 48 25	PH CSK SD SCR.7504-O ZP 4.8X25	100
1352 48 32	PH CSK SD SCR.7504-O ZP 4.8X32	100
9008 1	VAROIBOXX EMPTY	1
9008 1 12	VAROIBOXX THERMOF.INS.12COMP.	1

Article No.	Article Description	QTY
9007 1352	VAROIBOXX PHCSK SD S 7504 O GV	1



Pan Hd Self-Drill.Scr.7504 N(M), gv **VAROiBOXX**

- 1,050 pieces
- Pan head
- Galvanised steel

Contents

Article No.	Article Description	Quantity
1353 35 13	LH-TX15 SD SCR.7504N Z 3.5X13	100
1353 35 16	LH-TX15 SD SCR.7504N Z 3.5X16	100
1353 35 19	LH-TX15 SD SCR.7504N Z 3.5X19	100
1353 39 13	LH-TX20 SD SCR.7504N Z 3.9X13	100
1353 39 16	LH-TX20 SD SCR.7504N Z 3.9X16	100
1353 39 19	LH-TX20 SD SCR.7504N Z 3.9X19	100
1353 42 16	LH-TX20 SD SCR.7504N Z 4.2X16	100
1353 42 19	LH-TX20 SD SCR.7504N Z 4.2X19	100
1353 42 25	LH-TX20 SD SCR.7504N Z 4.2X25	50
1353 48 19	LH-TX25 SD SCR.7504N Z 4.8X19	100
1353 48 25	LH-TX25 SD SCR.7504N Z 4.8X25	50
1353 48 32	LH-TX25 SD SCR.7504N Z 4.8X32	50
9008 1	VAROiBOXX EMPTY	1
9008 1 12	VAROiBOXX THERMOF.INS.12COMP.	1

Article No.	Article Description	QTY
9007 1353	VAROiBOXX PAN HD S.DR.SC7504GV	1



Dome Hd Self-Drill.Scr.DIN 7504 N(M),A2 **VAROiBOXX**

- 1,100 pieces
- Pan head

Contents

Article No.	Article Description	Quantity
1355 35 95	PH CSK SD SCR.7504-O ZP3.5X9.5	100
1355 35 16	PH P HD SD SCR.7504M A2 3.5X16	100
1355 35 19	PH P HD SD SCR.7504M A2 3.5X19	100
1355 39 13	PH P HD SD SCR.7504M A2 3.9X13	100
1355 39 16	PH P HD SD SCR.7504M A2 3.9X16	100
1355 39 19	PH P HD SD SCR.7504M A2 3.9X19	100
1355 42 13	PH P HD SD SCR.7504M A2 4.2X13	100
1355 42 16	PH P HD SD SCR.7504M A2 4.2X16	100
1355 42 19	PH P HD SD SCR.7504M A2 4.2X19	100
1355 42 25	PH P HD SD SCR.7504M A2 4.2X25	50
1355 48 16	PH P HD SD SCR.7504M A2 4.8X16	100
1355 48 19	PH P HD SD SCR.7504M A2 4.8X19	50
9008 1	VAROiBOXX EMPTY	1
9008 1 12	VAROiBOXX THERMOF.INS.12COMP.	1

Article No.	Article Description	QTY
9007 1355	VAROiBOXX PH HD SD SCR7504M A2	1



Chipboard Scr.TX CSK Part.Thr. yellow

VAROIBOXX

- 450 parts
- Countersunk, partial thread
- Steel yellow galvanized
- Drive: TX

Contents

Article No.	Article Description	Quantity
1600 4 40	CSK TX15 CH.SCR.PT YCR 4X 40	100
1600 4 50	CSK TX15 CH.SCR.PT YCR 4X 50	50
1600 4 60	CSK TX15 CH.SCR.PT YGA 4X 60	50
1600 4 70	CSK TX15 CH.SCR.PT YCR 4X 70	50
1600 5 50	CSK TX25 CH.SCR.PT YCR 5X 50	50
1600 5 60	CSK TX25 CH.SCR.PT YCR 5X 60	50
1600 5 70	CSK TX25 CH.SCR.PT YGA 5X 70	50
1600 6 60	CSK TX25 CH.SCR.PT YGA 6X 60	50
4355 4	E6.3-1/4 BIT MAGNET HOLDER74MM	1
9008 1	VAROIBOXX EMPTY	1
9008 1 8	VAROIBOXX THERMOF.INS.8COMP.	1

Article No.	Article Description	QTY
9007 1600	VAROIBOXX CH SCR/TX/CSK/PT/YE	1



Chipboard Scr.TX Counters. PT 4,5–6 mm

VAROIBOXX

- 640 parts
- Yellow galvanized

Contents

Article No.	Article Description	Quantity
1600 45 40	SK-TX25 SPS TG GELB 4,5X 40	100
1600 45 45	CSK TX25 CH.SCR.PT YGA 4.5X 45	80
1600 45 50	CSK TX25 CH.SCR.PT YGA 4.5X 50	80
1600 45 60	CSK TX25 CH.SCR.PT YGA 4.5X 60	80
1600 45 70	CSK TX25 CH.SCR.PT YCR 4.5X 70	80
1600 5 50	CSK TX25 CH.SCR.PT YCR 5X 50	60
1600 5 60	CSK TX25 CH.SCR.PT YCR 5X 60	40
1600 5 70	CSK TX25 CH.SCR.PT YGA 5X 70	40
1600 6 60	CSK TX25 CH.SCR.PT YGA 6X 60	40
1600 6 70	CSK TX25 CH.SCR.PT YGA 6X 70	20
4314 5 25	1/4"BIT 25MM TX25 BLACK 5*	10
4355 4	E6.3-1/4 BIT MAGNET HOLDER74MM	1
9008 1	VAROIBOXX EMPTY	1
9008 1 12	VAROIBOXX THERMOF.INS.12COMP.	1

Article No.	Article Description	QTY
9007 1600 1	VAROIBOXX CHSCR/TX/CSK/FT4,5-6	1



Chipboard Scr.TX CSK Part.Thr. 3 – 4mm

VAROiBOXX

- 2,180 parts
- yellow galvanized

Contents

Article No.	Article Description	Quantity
1600 3 35	CSK TX10 CH.SCR.PTYCR 3X 35	400
1600 3 40	CSK TX10 CH.SCR.PTYCR 3X 40	400
1600 3 45	CSK TX10 CH.SCR.PTYCR 3X 45	250
1600 35 35	CSK TX15 CH.SCR.PTYCR 3.5X 35	200
1600 35 40	CSK TX15 CH.SCR.PTYCR 3.5X 40	200
1600 35 45	CSK TX15 CH.SCR.PTYCR 3.5X 45	200
1600 35 50	CSK TX15 CH.SCR.PTYCR 3.5X 50	100
1600 4 40	CSK TX15 CH.SCR.PTYCR 4X 40	150
1600 4 45	CSK TX15 CH.SCR.PTYCR 4X 45	100
1600 4 50	CSK TX15 CH.SCR.PTYCR 4X 50	80
1600 4 60	CSK TX15 CH.SCR.PTYCR 4X 60	50
1600 4 70	CSK TX15 CH.SCR.PTYCR 4X 70	50
9008 1	VAROiBOXX EMPTY	1
9008 1 12	VAROiBOXX THERMOF.INS.12COMP.	1

Article No.	Article Description	QTY
9007 1600 2	VAROiBOXX CHSCR/TX/CSK/PT3-4MM	1



Chipboard Scr.PZCounters.,Full Thread,gv VAROiBOXX

- 450 parts
- Countersunk, full thread
- Galvanised steel
- Drive: PZ

Contents

Article No.	Article Description	Quantity
1601 4 40	CSK PZ2 CHIPBSCR. GA 4X 40	100
1601 4 50	CSK PZ2 CHIPBSCR. GA 4X 50	50
1601 45 50	CSK PZ2 CHIPBSCR. GA 4.5X 50	50
1601 45 60	CSK PZ2 CHIPBSCR. GA 4.5X 60	50
1601 5 50	CSK PZ2 CHIPBSCR. ZP 5X 50	50
1601 5 60	CSK PZ2 CHIPBSCR. ZP 5X 60	50
1601 5 70	CSK PZ2 CHIPBSCR. GA 5X 70	50
1601 6 60	CSK PZ3 CHIPBSCR. GA 6X 60	50
9008 1	VAROiBOXX EMPTY	1
9008 1 8	VAROiBOXX THERMOF.INS.8COMP.	1

Article No.	Article Description	QTY
9007 1601	VAROiBOXX CSK PZ2 CHIPBSCR.GV	1



Chipboard Scr. PZ Counters.FT 4,5 × 6 mm

VAROIBOXX

- 840 parts
- Galvanized steel

Contents

Article No.	Article Description	Quantity
1601 45 30	CSK PZ2 CHIPBSCR. ZP 4.5X 30	200
1601 45 40	CSK PZ2 CHIPBSCR. ZP 4.5X 40	100
1601 45 50	CSK PZ2 CHIPBSCR. GA 4.5X 50	80
1601 45 60	CSK PZ2 CHIPBSCR. GA 4.5X 60	80
1601 5 40	CSK PZ2 CHIPBSCR. ZP 5X 40	100
1601 5 50	CSK PZ2 CHIPBSCR. ZP 5X 50	60
1601 5 60	CSK PZ2 CHIPBSCR. ZP 5X 60	40
1601 5 70	CSK PZ2 CHIPBSCR. GA 5X 70	40
1601 6 40	CSK PZ3 CHIPBSCR. ZP 6X 40	40
1601 6 50	CSK PZ3 CHIPBSCR. ZP 6X 50	40
1601 6 60	CSK PZ3 CHIPBSCR. GA 6X 60	40
1601 6 70	CSK PZ3 CHIPBSCR. GA 6X 70	20
9008 1	VAROIBOXX EMPTY	1
9008 1 12	VAROIBOXX THERMOF.INS.12COMP.	1

Article No.	Article Description	QTY
9007 1601 1	VAROIBOXX CHSCR/PZ/CSK/FT4,5-6	1



Chipboard Scr. PZ Counters. PT 3 – 4 mm

VAROIBOXX

- 3,950 parts
- Galvanized steel

Contents

Article No.	Article Description	Quantity
1601 3 15	CSK PZ1 CHIPBSCR. ZP 3X 15	1000
1601 3 20	CSK PZ1 CHIPBSCR. GA 3X 20	600
1601 3 25	CSK PZ1 CHIPBSCR. GA 3X 25	500
1601 3 30	CSK PZ1 CHIPBSCR. GA 3X 30	400
1601 35 25	CSK PZ2 CHIPBSCR. GA 3.5X 25	400
1601 35 30	CSK PZ2 CHIPBSCR. GA 3.5X 30	200
1601 35 40	CSK PZ2 CHIPBSCR. ZP 3.5X 40	200
1601 35 50	CSK PZ2 CHIPBSCR. ZP 3.5X 50	100
1601 4 30	CSK PZ2 CHIPBSCR. GA 4X 30	200
1601 4 40	CSK PZ2 CHIPBSCR. GA 4X 40	150
1601 4 45	CSK PZ2 CHIPBSCR. GA 4X 45	100
1601 4 50	CSK PZ2 CHIPBSCR. GA 4X 50	100
9008 1	VAROIBOXX EMPTY	1
9008 1 12	VAROIBOXX THERMOF.INS.12COMP.	1

Article No.	Article Description	QTY
9007 1601 2	VAROIBOXX CHSCR/PZ/CSK/FT3-4MM	1



Chipboard Scr.PZ,Counters.gv,Part.Thr.gv,VAROiBOXX

- 450 pieces
- Countersunk, partial thread
- Galvanised steel
- Drive: PZ

Contents

Article No.	Article Description	Quantity
1602 4 40	CSK PZ2 CHIPBSCR.PT ZP 4X 40	100
1602 4 50	CSK PZ2 CHIPBSCR.PT ZP 4X 50	50
1602 4 60	CSK PZ2 CHIPBSCR.PT ZP 4X 60	50
1602 4 70	CSK PZ2 CHIPBSCR.PT ZP 4X 70	50
1602 5 50	CSK PZ2 CHIPBSCR.PT ZP 5X 50	50
1602 5 60	CSK PZ2 CHIPBSCR.PT ZP 5X 60	50
1602 5 70	CSK PZ2 CHIPBSCR.PT ZP 5X 70	50
1602 6 60	CSK PZ3 CHIPBSCR.PT GA 6X 60	50
9008 1	VAROiBOXX EMPTY	1
9008 1 8	VAROiBOXX THERMOF.INS.8COMP.	1

Article No.	Article Description	QTY
9007 1602	VAROiBOXX CSK PZ2 CHBSCR.PT GV	1



Chipboard Scr. PZ Counters.PT 4,5 – 6 mm VAROiBOXX

- 820 parts
- Galvanized steel

Contents

Article No.	Article Description	Quantity
1602 45 30	CSK PZ2 CHIPBSCR.PT ZP 4.5X 30	200
1602 45 40	CSK PZ2 CHIPBSCR.PT ZP 4.5X 40	100
1602 45 50	CSK PZ2 CHIPBSCR.PT ZP 4.5X 50	80
1602 45 60	CSK PZ2 CHIPBSCR.PT ZP 4.5X 60	80
1602 5 40	CSK PZ2 CHIPBSCR.PT ZP 5X 40	100
1602 5 50	CSK PZ2 CHIPBSCR.PT ZP 5X 50	60
1602 5 60	CSK PZ2 CHIPBSCR.PT ZP 5X 60	40
1602 5 70	CSK PZ2 CHIPBSCR.PT ZP 5X 70	40
1602 6 50	CSK PZ3 CHIPBSCR.PT ZP 6X 50	40
1602 6 60	CSK PZ3 CHIPBSCR.PT GA 6X 60	40
1602 6 70	CSK PZ3 CHIPBSCR.PT GA 6X 70	20
4312 5 2	1/4" PZ-BIT 25MM SZ.2 BLACK 5*	20
9008 1	VAROiBOXX EMPTY	1
9008 1 12	VAROiBOXX THERMOF.INS.12COMP.	1

Article No.	Article Description	QTY
9007 1602 1	VAROiBOXX CHSCR/PZ/CSK/PT4,5-6	1



Chipboard Scr. PZ Counters. PT 3 – 4 mm

VAROiBOXX

- 2,850 parts
- Galvanized steel

Contents

Article No.	Article Description	Quantity
1602 3 30	CSK PZ1 CHIPBSCR.PT ZP 3X 30	400
1602 3 35	CSK PZ1 CHIPBSCR.PT ZP 3X 35	400
1602 3 40	CSK PZ1 CHIPBSCR.PT ZP 3X 40	400
1602 3 45	CSK PZ1 CHIPBSCR.PT ZP 3X 45	300
1602 35 30	CSK PZ2 CHIPBSCR.PT ZP 3.5X 30	200
1602 35 35	CSK PZ2 CHIPBSCR.PT ZP 3.5X 35	200
1602 35 40	CSK PZ2 CHIPBSCR.PT ZP 3.5X 40	200
1602 35 50	CSK PZ2 CHIPBSCR.PT ZP 3.5X 50	100
1602 4 30	CSK PZ2 CHIPBSCR.PT ZP 4X 30	200
1602 4 40	CSK PZ2 CHIPBSCR.PT ZP 4X 40	150
1602 4 45	CSK PZ2 CHIPBSCR.PT ZP 4X 45	100
1602 4 50	CSK PZ2 CHIPBSCR.PT ZP 4X 50	100
9008 1	VAROiBOXX EMPTY	1
9008 1 12	VAROiBOXX THERMOF.INS.12COMP.	1

Article No.	Article Description	QTY
9007 1602 2	VAROiBOXX CHSCR/PZ/CSK/PT3-4MM	1



Chipboard Screws / Caps VAROiBOXX

- 1,810 parts
- Screws made of galvanized steel with drilled hole
- Caps Ø 12 mm in different colours

Contents

Article No.	Article Description	Quantity
1606 45 30	CSK-PZ2-CHIPB.SCREW GA 4.5X30	200
1606 45 35	CSK-PZ2-CHIPB.SCREW GA 4.5X35	100
1606 45 40	CSK-PZ2-CHIPB.SCREW GA 4.5X40	100
1606 45 50	CSK-PZ2-CHIPB.SCREW GA 4.5X50	80
1606 45 60	CSK-PZ2-CHIPB.SCREW GA 4.5X60	80
1606 45 70	CSK-PZ2-CHIPB.SCR.GA PT 4.5X70	50
1650 0	COV.CAP FOR CHIPB.SCREW WHITE	200
1650 3	COV.CAP F.CHIPB.SCR.DARK-BROWN	200
1650 8	COV.CAP FOR CHIPB.SCREW BLACK	200
1650 9	COV.CAP F.CHIPB.SCR.LIGHT-GREY	200
1650 10	COV.CAP F.CHIPB.SCR.SILV.GREY	200
1650 11	COV.CAP F.CHIPB.SCR.DUST-GREY	200
9008 1	VAROiBOXX EMPTY	1
9008 1 12	VAROiBOXX THERMOF.INS.12COMP.	1

Article No.	Article Description	QTY
9007 1606 1650	VAROiBOXX CH SCR/PZ/CSK/CAPS	1



Chipboard Screws TX Panhead **VAROIBOXX**

- 920 parts
- Galvanized steel

Contents

Article No.	Article Description	Quantity
1612 45 20	PAN-H TX25 CHIPB. GA 4.5X 20	200
1612 45 30	CBS PAN-H TX25 FT ZP 4.5X 30	100
1612 45 40	PAN-H TX25 CHIPB. GA 4.5X 40	100
1612 45 50	PAN-H TX25 CHIPB. GA 4.5X 50	80
1612 5 30	PAN-H TX25 CHIPB. GA 5 X30	100
1612 5 40	PAN-H TX25 CHIPB. GA 5 X40	100
1612 5 50	PAN-H TX25 CHIPB. GA 5 X50	60
1612 5 60	60S PAN-H TX25 FT ZP 5X60	40
1612 6 40	CBS PAN-H TX25 FT ZP 6X40	40
1612 6 50	CBS PAN-H TX25 FT ZP 6X50	40
1612 6 60	CBS PAN-H TX25 FT ZP 6X60	40
1612 6 70	CBS PAN-H TX25 FT ZP 6X70	20
9008 1	VAROIBOXX EMPTY	1
9008 1 12	VAROIBOXX THERMOF.INS.12COMP.	1

Article No.	Article Description	QTY
9007 1612	VAROIBOXX CHSCR/TX/PANH4,5-6MM	1



Decorhd Scr.TX Dr.Tip,GV **VAROIBOXX**

- 500 parts
- Extra small decor head (60°)
- Drive: TX
- Countersunk head with ribs
- Drill tip
- Galvanised steel

Contents

Article No.	Article Description	Quantity
1614 1 32 20	DEC.HEAD SCR.DT TX10 GA 3.2X20	100
1614 1 32 25	DEC.HEAD SCR.DT TX10 GA 3.2X25	100
1614 1 32 30	DEC.HEAD SCR.DT TX10 GA 3.2X30	100
1614 1 32 35	DEC.HEAD SCR.DT TX10 GA 3.2X35	50
1614 1 32 40	DEC.HEAD SCR.DT TX10 GA 3.2X40	50
1614 1 32 50	DEC.HEAD SCR.DT TX10 GA 3.2X50	50
1614 1 32 60	DEC.HEAD SCR.DT TX10 GA 3.2X60	50
9008 1	VAROIBOXX EMPTY	1
9008 1 8	VAROIBOXX THERMOF.INS.8COMP.	1

Article No.	Article Description	QTY
9007 1614 1	VAROIBOXX DEC.HD SCR DT TX10	1



Chipboard Scr.TX Counters. FT 4,5 – 6 mm

VAROiBOXX

- 920 parts
- Galvanized steel

Contents

Article No.	Article Description	Quantity
1626 45 30	CSK-TX25 CHIPB.SCR.FT ZP4.5X30	200
1626 45 40	CSK-TX25 CHIPB.SCR.FT ZP4.5X40	100
1626 45 50	CSK-TX25 CHIPB.SCR.FT ZP4.5X50	80
1626 45 60	CSK-TX25 CHIPB.SCR.FT ZP4.5X60	80
1626 5 30	CSK-TX25 CHIPB.SCR.FT ZP 5X30	100
1626 5 40	CSK-TX25 CHIPB.SCR.FT ZP 5X40	100
1626 5 50	CSK-TX25 CHIPB.SCR.FT ZP 5X50	60
1626 5 60	CSK-TX25 CHIPB.SCR.FT ZP 5X60	40
1626 6 40	CSK-TX25 CHIPB.SCR.FT ZP 6X40	40
1626 6 45	CSK-TX25 CHIPB.SCR.FT ZP 6X45	40
1626 6 50	CSK-TX25 CHIPB.SCR.FT ZP 6X50	40
1626 6 60	CSK-TX25 CHIPB.SCR.FT ZP 6X60	40
9008 1	VAROiBOXX EMPTY	1
9008 1 12	VAROiBOXX THERMOF.INS.12COMP.	1

Article No.	Article Description	QTY
9007 1626	VAROiBOXX SPS/TX/SK/VG 4,5-6MM	1



Chipboard Screws TX Counters.FT 3 – 4 mm

VAROiBOXX

- 3,950 parts
- Galvanized steel

Contents

Article No.	Article Description	Quantity
1626 3 16	CSK-TX10 CHIPB.SCR.FT ZP 3X16	1000
1626 3 20	CSK-TX10 CHIPB.SCR.FT GA 3X20	600
1626 3 25	CSK-TX10 CHIPB.SCR.FT ZP 3X25	500
1626 3 30	CSK-TX10 CHIPB.SCR.FT GA 3X30	400
1626 35 25	CSK-TX15 CHIPB.SCR.FT ZP3.5X25	400
1626 35 30	CSK-TX15 CHIPB.SCR.FT GA3.5X30	200
1626 35 40	CSK-TX15 CHIPB.SCR.FT GA3.5X40	200
1626 35 50	CSK-TX15 CHIPB.SCR.FT ZP3.5X50	100
1626 4 30	CSK-TX15 CHIPB.SCR.FT GA 4X30	200
1626 4 40	CSK-TX15 CHIPB.SCR.FT GA 4X40	150
1626 4 45	CSK-TX15 CHIPB.SCR.FT ZP 4X45	100
1626 4 50	CSK-TX15 CHIPB.SCR.FT GA 4X50	100
9008 1	VAROiBOXX EMPTY	1
9008 1 12	VAROiBOXX THERMOF.INS.12COMP.	1

Article No.	Article Description	QTY
9007 1626 1	VAROiBOXX CHSCR/TX/CSK/FT 3-4	1



Hardwood Facade Scr.TX,CSK Hd w.Ribs

VAROiBOXX

- 405 pieces
- Drive: TX
- With countersunk head with rib, end mill and milltec-drill tip
- 60 % higher fracture torque than A2 and A4 wood screws
- Easy countersinking in all types of wood

Contents

Article No.	Article Description	Quantity
1627 4 40	TX15 CSK RIB HAWOFAC.SCREW4X40	50
1627 4 45	TX15 CSK RIB HAWOFAC.SCREW4X45	50
1627 4 50	TX15 CSK RIB HAWOFAC.SCREW4X50	50
1627 4 60	TX15 CSK RIB HAWOFAC.SCREW4X60	25
1627 45 50	TX20 CSK RIB HAWOFAC.SCR4.5X50	25
1627 45 60	TX20 CSK RIB HAWOFAC.SCR4.5X60	25
1627 45 70	TX20 CSK RIB HAWOFAC.SCR4.5X70	25
1627 5 40	TX25 CSK RIB HAWOFAC.SCREW5X40	50
1627 5 50	TX25 CSK RIB HAWOFAC.SCREW5X50	25
1627 5 60	TX25 CSK RIB HAWOFAC.SCRTR5X60	25
1627 5 70	TX25 CSK RIB HAWOFAC.SCREW5X70	25
4314 5 15	1/4"BIT 25MM TX15 YELLOW 5*	10
4314 5 20	1/4"BIT 25MM TX20 WHITE 5*	10
4314 5 25	1/4"BIT 25MM TX25 BLACK 5*	10
9008 1	VAROiBOXX EMPTY	1
9008 1 12	VAROiBOXX THERMOF.INS.12COMP.	1



Article No.	Article Description	QTY
9007 1627	VAROiBOXX CSK TX RIB HAWOFAC S	1

Wood Screws TX CSK Hd.w.Ribs YEL 4–5 mm

VAROiBOXX

- 1,750 parts
- Yellow galvanized

Contents

Article No.	Article Description	Quantity
1628 4 25	FSK-TX20 WOSCR.FT YELLOW 4X 25	300
1628 4 30	FSK-TX20 WOSCR.PT YELLOW 4X 30	300
1628 4 35	FSK-TX20 WOSCR.PT YELLOW 4X 35	200
1628 4 40	FSK-TX20 WOSCR.PT YELLOW 4X 40	200
1628 45 40	FSK-TX25 WOSCR.PT YELLOW4.5X40	125
1628 45 45	FSK-TX25 WOSCR.PT YELLOW4.5X45	100
1628 45 50	FSK-TX25 WOSCR.PT YELLOW4.5X50	100
1628 45 60	FSK-TX25 WOSCR.PT YELLOW4.5X60	100
1628 5 50	FSK-TX25 WOSCR.PT YELLOW 5X 50	75
1628 5 60	FSK-TX25 WOSCR.PT YELLOW 5X 60	50
1628 5 70	FSK-TX25 WOSCR.PT YELLOW 5X 70	50
1628 5 80	FSK-TX25 WOSCR.PT YELLOW 5X 80	50
9008 1	VAROiBOXX EMPTY	1
9008 1 12	VAROiBOXX THERMOF.INS.12COMP.	1



Article No.	Article Description	QTY
9007 1628	VAROiBOXX TX-CSK HD.RIB YE 4-5	1

Wood Screws CSK Hd TX 4 – 5 mm **VARO iBOXX**

- 1,675 parts
- Galvanised steel

Contents

Article No.	Article Description	Quantity
1629 4 25	FSK-TX20 WOODSCR.FT GA 4X25	300
1629 4 30	FSK-TX20 WOODSCR.PT GA 4X30	300
1629 4 35	FSK-TX20 WOODSCR.PT GA 4X35	200
1629 4 40	FSK-TX20 WOODSCR.PT GA 4X40	200
1629 45 40 20	FSK-TX20 HOBAUS.TG VZ 4,5 X 40	150
1629 45 45 20	FSK-TX20 HOBAUS.TG VZ 4,5 X 45	150
1629 45 50 20	FSK-TX20 HOBAUS.TG VZ 4,5 X 50	100
1629 45 60 20	FSK-TX20 HOBAUS.TG VZ 4,5 X 60	75
1629 5 50 20	FSK-TX20 HOBAUS.TG VZ 5 X 50	75
1629 5 60 20	FSK-TX20 HOBAUS.TG VZ 5 X 60	50
1629 5 70 20	FSK-TX20 HOBAUS.TG VZ 5 X 70	50
1629 5 80 20	FSK-TX20 HOBAUS.TG VZ 5 X 80	25
9008 1	VAROIBOXX EMPTY	1
9008 1 12	VAROIBOXX THERMOF.INS.12COMP.	1

Article No.	Article Description	QTY
9007 1629	VAROIBOXX TX-CSK HD.W.RIB4-5MM	1



Nuts, Washers A, Spr.Lock, Washers, gv **VARO iBOXX**

- 2,900 pieces
- Galvanised steel

Contents

Article No.	Article Description	Quantity
2001 4	HEX NUT 934-8 GA 4	300
2001 5	HEX NUT 934-8 GA 5	300
2001 6	HEX NUT 934-8 GA 6	300
2001 8	HEX NUT 934-8 GA 8	100
2301 4	WASHER 125 A GA 4	300
2301 5	WASHER 125 A GA 5	300
2301 6	WASHER 125 A GA 6	200
2301 8	WASHER 125 A GA 8	100
2501 4	SPRING WASHER 127 GA 4	300
2501 5	SPRING WASHER 127 GA 5	300
2501 6	SPRING WASHER 127 GA 6	300
2501 8	SPRING WASHER 127 GA 8	100
9008 1	VAROIBOXX EMPTY	1
9008 1 12	VAROIBOXX THERMOF.INS.12COMP.	1

Article No.	Article Description	QTY
9007 2	VAROIBOXX M/S/F 934/125A/127GV	1



Hex Nuts DIN 934-8, gv **VAROiBOXX**

- 900 pieces
- Complies with ISO 4032
- Strength class 8
- **Galvanised steel**

Contents

Article No.	Article Description	Quantity
2001 4	HEX NUT 934-8 GA 4	200
2001 5	HEX NUT 934-8 GA 5	200
2001 6	HEX NUT 934-8 GA 6	200
2001 8	HEX NUT 934-8 GA 8	150
2001 10	HEX NUT 934-8 GA 10	50
2001 12	HEX NUT 934-8 GA 12	50
2001 14	HEX NUT 934-8 GA 14	25
2001 16	HEX NUT 934-8 GA 16	25
9008 1	VAROiBOXX EMPTY	1
9008 1 8	VAROiBOXX THERMOF.INS.8COMP.	1

Article No.	Article Description	QTY
9007 2001	VAROiBOXX HEX NUTS 934-8 GV	1



Hex Nuts DIN 934, Stainless Steel A2 **VAROiBOXX**

- 900 pieces
- Complies with ISO 4032
- **Stainless steel A2**

Contents

Article No.	Article Description	Quantity
2005 4	HEX NUT 934 A2 4	200
2005 5	HEX NUT 934 A2 5	200
2005 6	HEX NUT 934 A2 6	200
2005 8	HEX NUT 934 A2 8	150
2005 10	HEX NUT 934 A2 10	50
2005 12	HEX NUT 934 A2 12	50
2005 14	HEX NUT 934 A2 14	25
2005 16	HEX NUT 934 A2 16	25
9008 1	VAROiBOXX EMPTY	1
9008 1 8	VAROiBOXX THERMOF.INS.8COMP.	1

Article No.	Article Description	QTY
9007 2005	VAROiBOXX HEX NUTS 934 A2	1



Hex Cap Nuts DIN 1587, Stainless St. A2 **VAROiBOXX**

- 440 pieces
- High type
- Hex cap nut
- **Stainless steel A2**

Contents

Article No.	Article Description	Quantity
2065 4	HEX CAP NUT HIGH 1587 A2 4	100
2065 5	HEX CAP NUT HIGH 1587 A2 5	100
2065 6	HEX CAP NUT HIGH 1587 A2 6	100
2065 8	HEX CAP NUT HIGH 1587 A2 8	50
2065 10	HEX CAP NUT HIGH 1587 A2 10	25
2065 12	HEX CAP NUT HIGH 1587 A2 12	20
2065 14	HEX CAP NUT HIGH 1587 A2 14	15
2065 16	HEX CAP NUT HIGH 1587 A2 16	10
9008 1	VAROIBOXX EMPTY	1
9008 1 8	VAROIBOXX THERMOF.INS.8COMP.	1

Article No.	Article Description	QTY
9007 2065	VAROIBOXX HEX CAP N.H.1587 A2	1



Serrated Lock.Nuts DIN 6923,gv **VAROiBOXX**

- 675 pieces
- Strength class 8
- **Galvanised steel**

Contents

Article No.	Article Description	Quantity
2073 4	SERRATED LOCKING NUT ZN M 4	250
2073 5	SERRATED LOCKING NUT ZN M 5	100
2073 6	SERRATED LOCKING NUT ZN M 6	100
2073 8	SERRATED LOCKING NUT ZN M 8	100
2073 10	SERRATED LOCKING NUT ZN M 10	50
2073 12	SERRATED LOCKING NUT ZN M 12	25
2073 14	SERRATED LOCKING NUT ZN M 14	25
2073 16	SERRATED LOCKING NUT ZN M 16	25
9008 1	VAROiBOXX EMPTY	1
9008 1 8	VAROiBOXX THERMOF.INS.8COMP.	1

Article No.	Article Description	QTY
9007 2073	VAROiBOXX SERR.LO.NUTS 6923 GV	1



Hex Nylock Nuts DIN 985-8,gv **VAROiBOXX**

- 650 pieces
- Complies with ISO 10511
- Strength class 8
- Self-locking with polyamide ring
- **Galvanised steel**

Contents

Article No.	Article Description	Quantity
2101 4	NYLOCK NUT 985-8 4	100
2101 5	NYLOCK NUT 985-8 5	100
2101 6	NYLOCK NUT 985-8 6	150
2101 8	NYLOCK NUT 985-8 8	150
2101 10	NYLOCK NUT 985-8 10	50
2101 12	NYLOCK NUT 985-8 12	50
2101 14	NYLOCK NUT 985-8 14	25
2101 16	NYLOCK NUT 985-8 16	25
9008 1	VAROiBOXX EMPTY	1
9008 1 8	VAROiBOXX THERMOF.INS.8COMP.	1

Article No.	Article Description	QTY
9007 2101	VAROiBOXX HEX NYLOCK N.958-8GV	1



Hex Nylock Nuts DIN 985, Stainl.St.A2 **VAROiBOXX**

- 525 pieces
- Complies with ISO 10511
- With polyamide lock
- **Stainless steel A2**

Contents

Article No.	Article Description	Quantity
2105 4	NYLOCK NUT 985 A2 4	100
2105 5	NYLOCK NUT 985 A2 5	100
2105 6	NYLOCK NUT 985 A2 6	100
2105 8	NYLOCK NUT 985 A2 8	100
2105 10	NYLOCK NUT 985 A2 10	50
2105 12	NYLOCK NUT 985 A2 12	25
2105 14	NYLOCK NUT 985 A2 14	25
2105 16	NYLOCK NUT 985 A2 16	25
9008 1	VAROiBOXX EMPTY	1
9008 1 8	VAROiBOXX THERMOF.INS.8COMP.	1

Article No.	Article Description	QTY
9007 2105	VAROiBOXX HEX NYL.NUT 985-8 A2	1



Hex Spacer Sleeves, gv **VAROiBOXX**

- 180 pieces
- Galvanised steel

Contents

Article No.	Article Description	Quantity
2202 6 25	HEX-DISTANCE SLEEVE GA M6X25	25
2202 6 30	HEX-DISTANCE SLEEVE GA M6X30	25
2202 8 25	HEX-DISTANCE SLEEVE GA M8X25	25
2202 8 30	HEX-DISTANCE SLEEVE GA M8X30	25
2202 10 30	HEX-DISTANCE SLEEVE GA M10X30	20
2202 10 40	HEX-DISTANCE SLEEVE GA M10X40	20
2202 12 30	HEX-DISTANCE SLEEVE GA M12X30	20
2202 12 40	HEX-DISTANCE SLEEVE GA M12X40	20
9008 1	VAROiBOXX EMPTY	1
9008 1 8	VAROiBOXX THERMOF.INS.8COMP.	1

Article No.	Article Description	QTY
9007 2202	VAROiBOXX HEX SPACER SLEEV.GV	1



Washers DIN 125 Shape A, gv **VAROiBOXX**

- 1,050 pieces
- Complies with ISO 7089
- **Galvanised steel**

Contents

Article No.	Article Description	Quantity
2301 4	WASHER 125 A GA 4	200
2301 5	WASHER 125 A GA 5	200
2301 6	WASHER 125 A GA 6	200
2301 8	WASHER 125 A GA 8	200
2301 10	WASHER 125 A GA 10	100
2301 12	WASHER 125 A GA 12	50
2301 14	WASHER 125 A GA 14	50
2301 16	WASHER 125 A GA 16	50
9008 1	VAROIBOXX EMPTY	1
9008 1 8	VAROIBOXX THERMOF.INS.8COMP.	1

Article No.	Article Description	QTY
9007 2301	VAROIBOXX WASHERS 125A GV	1



Washers DIN 125, Stainless Steel A2 **VAROiBOXX**

- 850 pieces
- Complies with ISO 7089
- Shape A (without chamfer)
- **Stainless steel A2**

Contents

Article No.	Article Description	Quantity
2305 4	WASHER 125 A2 4	200
2305 5	WASHER 125 A2 5	200
2305 6	WASHER 125 A2 6	100
2305 8	WASHER 125 A2 8	100
2305 10	WASHER 125 A2 10	100
2305 12	WASHER 125 A2 12	50
2305 14	WASHER 125 A2 14	50
2305 16	WASHER 125 A2 16	50
9008 1	VAROiBOXX EMPTY	1
9008 1 8	VAROiBOXX THERMOF.INS.8COMP.	1

Article No.	Article Description	QTY
9007 2305	VAROiBOXX WASHERS 125 A2	1



Washers DIN 9012, gv **VAROiBOXX**

- 550 pieces
- Complies with ISO 7093
- **Galvanised steel**

Contents

Article No.	Article Description	Quantity
2311 4	WASHER 9021 GA 4	100
2311 5	WASHER 9021 ZI 5	100
2311 6	WASHER 9021 ZI 6	100
2311 8	WASHER 9021 ZI 8	100
2311 10	WASHER 9021 ZI 10	50
2311 12	WASHER 9021 ZI 12	50
2311 14	WASHER 9021 ZI 14	25
2311 16	WASHER 9021 ZI 16	25
9008 1	VAROiBOXX EMPTY	1
9008 1 8	VAROiBOXX THERMOF.INS.8COMP.	1

Article No.	Article Description	QTY
9007 2311	VAROiBOXX WASHERS 9021 GV	1



Washers DIN 9021, Stainl.St. A2 **VAROiBOXX**

- 500 pieces
- Complies with ISO 7093
- **Stainless steel A2**

Contents

Article No.	Article Description	Quantity
2315 4	WASHER 9021 A2 4	100
2315 5	WASHER 9021 A2 5	100
2315 6	WASHER 9021 A2 6	100
2315 8	WASHER 9021 A2 8	50
2315 10	WASHER 9021 A2 10	50
2315 12	WASHER 9021 A2 12	50
2315 14	WASHER 9021 A2 14	25
2315 16	WASHER 9021 A2 16	25
9008 1	VAROiBOXX EMPTY	1
9008 1 8	VAROiBOXX THERMOF.INS.8COMP.	1

Article No.	Article Description	QTY
9007 2315	VAROiBOXX WASHERS 9021 A2	1



Washers DIN 1052, gv **VAROiBOXX**

- 65 pieces
- Washers for wood connectors
- **Galvanised steel**

Contents

Article No.	Article Description	Quantity
2318 12	WASHER DIN 1052 ZI F. M 12	25
2318 16	WASHER DIN 1052 ZI F. M 16	25
2318 20	WASHER DIN 1052 ZI F. M 20	10
2318 24	WASHER DIN 1052 ZI F. M 24	5
9008 1	VAROiBOXX EMPTY	1
9008 1 4	VAROiBOXX THERMOF.INS.4COMP.	1

Article No.	Article Description	QTY
9007 2318	VAROiBOXX WASHERS 1052 GV	1



Body Washers, gv **VAROiBOXX**

- 900 pieces
- Galvanised steel

Contents

Article No.	Article Description	Quantity
2331 5 20	PANEL REP WASHER GA 5X20	100
2331 5 25	PANEL REP WASHER GA 5X25	100
2331 5 30	PANEL REP WASHER GA 5X30	50
2331 6 15	PANEL REP WASHER GA 6X15	100
2331 6 20	PANEL REP WASHER GA 6X20	100
2331 6 25	PANEL REP WASHER GA 6X25	100
2331 6 30	PANEL REP WASHER GA 6X30	50
2331 8 25	PANEL REP WASHER GA 8X25	100
2331 8 30	PANEL REP WASHER GA 8X30	50
2331 8 40	PANEL REP WASHER GA 8X40	50
2331 10 30	PANEL REP WASHER GA 10X30	50
2331 10 40	PANEL REP WASHER GA 10X40	50
9008 1	VAROiBOXX EMPTY	1
9008 1 12	VAROiBOXX THERMOF.INS.12COMP.	1

Article No.	Article Description	QTY
9007 2331	VAROiBOXX PANEL REP WASCH.GV	1



Large Diameter Wash.Stainl.St.A2 **VAROiBOXX**

- 575 pieces
- Galvanised steel

Contents

Article No.	Article Description	Quantity
2335 5 15	PANEL REP WASHER A2 5X15	50
2335 5 20	PANEL REP WASHER A2 5X20	50
2335 5 25	PANEL REP WASHER A2 5X25	50
2335 5 30	PANEL REP WASHER A2 5X30	25
2335 6 20	PANEL REP WASHER A2 6X20	100
2335 6 25	PANEL REP WASHER A2 6X25	100
2335 6 30	PANEL REP WASHER A2 6X30	50
2335 8 25	PANEL REP WASHER A2 8X25	50
2335 8 30	PANEL REP WASHER A2 8X30	25
2335 8 40	PANEL REP WASHER A2 8X40	25
2335 10 30	PANEL REP WASHER A2 10X30	25
2335 10 40	PANEL REP WASHER A2 10X40	25
9008 1	VAROiBOXX EMPTY	1
9008 1 12	VAROiBOXX THERMOF.INS.12COMP.	1

Article No.	Article Description	QTY
9007 2335	VAROiBOXX PAN.REP.WA.SERIES A2	1



Spring Washers DIN 137 A/B,gv **VAROiBOXX**

- 2,050 pieces
- Galvanised steel

Contents

Article No.	Article Description	Quantity
2321 3	SPRING WASHER137 A GA 3	200
2321 4	SPRING WASHER137 A GA 4	200
2321 5	SPRING WASHER137 A GA 5	200
2321 6	SPRING WASHER137 A GA 6	200
2321 8	SPRING WASHER137 A GA 8	200
2321 10	SPRING WASHER137 A GA 10	100
2322 4	SPRING WASHER137 B GA 4	200
2322 5	SPRING WASHER137 B GA 5	200
2322 6	SPRING WASHER137 B GA 6	200
2322 8	SPRING WASHER137 B GA 8	200
2322 10	SPRING WASHER137 B GA 10	100
2322 12	SPRING WASHER137 B GA 12	50
9008 1	VAROIBOXX EMPTY	1
9008 1 12	VAROIBOXX THERMOF.INS.12COMP.	1

Article No.	Article Description	QTY
9007 232	VAROIBOXX SPR.WASH.137A/B GV	1



Spring Washers DIN 127,gv **VAROiBOXX**

- 1,100 pieces
- Galvanised steel

Contents

Article No.	Article Description	Quantity
2501 4	SPRING WASHER 127 GA 4	200
2501 5	SPRING WASHER 127 GA 5	200
2501 6	SPRING WASHER 127 GA 6	200
2501 8	SPRING WASHER 127 GA 8	200
2501 10	SPRING WASHER 127 GA 10	100
2501 12	SPRING WASHER 127 GA 12	100
2501 14	SPRING WASHER 127 GA 14	50
2501 16	SPRING WASHER 127 GA 16	50
9008 1	VAROiBOXX EMPTY	1
9008 1 8	VAROiBOXX THERMOF.INS.8COMP.	1

Article No.	Article Description	QTY
9007 2501	VAROiBOXX SPRING WASH.127 GV	1



External Circlips DIN 471 for Shafts **VAROiBOXX**

- 715 parts
- Phosphated steel

Contents

Article No.	Article Description	Quantity
2541 8	RET RING F. SHAFT 471 A 8	100
2541 10	RET RING F. SHAFT 471 A 10	100
2541 12	RET RING F. SHAFT 471 A 12	100
2541 14	RET RING F. SHAFT 471 A 14	50
2541 15	RET RING F. SHAFT 471 A 15	50
2541 16	RET RING F. SHAFT 471 A 16	50
2541 17	RET RING F. SHAFT 471 A 17	25
2541 18	RET RING F. SHAFT 471 A 18	25
2541 20	RET RING F. SHAFT 471 A 20	25
2541 22	RET RING F. SHAFT 471 A 22	25
2541 24	RET RING F. SHAFT 471 A 24	25
2541 25	RET RING F. SHAFT 471 A 25	25
2541 26	RET RING F. SHAFT 471 A 26	25
2541 28	RET RING F. SHAFT 471 A 28	20
2541 30	RET RING F. SHAFT 471 A 30	20
2541 32	RET RING F. SHAFT 471 A 32	20
2541 35	RET RING F. SHAFT 471 A 35	20
2541 40	RET RING F. SHAFT 471 A 40	10
9008 1	VAROiBOXX EMPTY	1
9008 1 18	VAROiBOXX THERMOF.INS.18COMP.	1



Article No.	Article Description	QTY
9007 2541	VAROiBOXX CIRCLIPS 471 A	1

Internal Circlips DIN 472 for Bores **VAROiBOXX**

- 480 pieces
- Phosphated steel

Contents

Article No.	Article Description	Quantity
2542 15	RET RING F. SHAFT 472 I 15	50
2542 16	RET RING F. SHAFT 472 I 16	50
2542 18	RET RING F. SHAFT 472 I 18	50
2542 20	RET RING F. SHAFT 472 I 20	50
2542 22	RET RING F. SHAFT 472 I 22	25
2542 23	RET RING F. SHAFT 472 I 23	25
2542 24	RET RING F. SHAFT 472 I 24	25
2542 25	RET RING F. SHAFT 472 I 25	25
2542 26	RET RING F. SHAFT 472 I 26	25
2542 28	RET RING F. SHAFT 472 I 28	25
2542 30	RET RING F. SHAFT 472 I 30	25
2542 32	RET RING F. SHAFT 472 I 32	25
2542 34	RET RING F. SHAFT 472 I 34	20
2542 35	RET RING F. SHAFT 472 I 35	20
2542 36	RET RING F. SHAFT 472 I 36	10
2542 38	RET RING F. SHAFT 472 I 38	10
2542 40	RET RING F. SHAFT 472 I 40	10
2542 42	RET RING F. SHAFT 472 I 42	10
9008 1	VAROiBOXX EMPTY	1
9008 1 18	VAROiBOXX THERMOF.INS.18COMP.	1



Article No.	Article Description	QTY
9007 2542	VAROiBOXX INTERN.CIRCL.472 I	1

O-Rings, Metric **VAROiBOXX**

- 360 pieces

Contents

Article No.	Article Description	Quantity
2650 15 3	O-RING NBR 1.5X 3	25
2650 15 5	O-RING NBR 1.5X 5	25
2650 15 7	O-RING NBR 1.5X 7	25
2650 2 6	O-RING NBR 2 X6	25
2650 2 8	O-RING NBR 2 X8	25
2650 2 10	O-RING NBR 2 X10	25
2650 25 10	O-RING NBR 2.5X10	20
2650 25 12	O-RING NBR 2.5X12	20
2650 25 15	O-RING NBR 2.5X15	20
2650 3 14	O-RING NBR 3 X14	20
2650 3 16	O-RING NBR 3 X16	20
2650 3 18	O-RING NBR 3 X18	20
2650 3 20	O-RING NBR 3 X20	15
2650 3 22	O-RING NBR 3 X22	15
2650 3 24	O-RING NBR 3 X24	15
2650 3 26	O-RING NBR 3 X26	15
2650 3 28	O-RING NBR 3 X28	15
2650 3 30	O-RING NBR 3 X30	15
9008 1	VAROiBOXX EMPTY	1
9008 1 18	VAROiBOXX THERMOF.INS.18COMP.	1



Article No.	Article Description	QTY
9007 2650	VAROiBOXX O-RINGS METRIC	1

Blind Rivet w.Mushr.Head AL/St. **VARO iBOXX**

- 529 pieces
- 1 × Art. No. 2722 1: hand rivet gun MFX 150 B

Contents

Article No.	Article Description	Quantity
2710 32 8	BLIND RIV.TRUSS-HD AL/ST 3.2X8	50
2710 32 10	BLIND RIV.TRUSS-HD AL/ST3.2X10	50
2710 32 12	BLIND RIV.TRUSS-HD AL/ST3.2X12	50
2710 4 10	BLIND RIV.TRUSS-HD AL/ST 4X10	50
2710 4 12	BLIND RIV.TRUSS-HD AL/ST 4X12	50
2710 4 16	BLIND RIV.TRUSS-HD AL/ST 4X16	50
2710 48 12	BLIND RIV.TRUSS-HD AL/ST4.8X12	50
2710 48 16	BLIND RIV.TRUSS-HD AL/ST4.8X16	50
2710 5 8	BLIND RIV.TRUSS-HD AL/ST 5X8	50
2710 5 10	BLIND RIV.TRUSS-HD AL/ST 5X10	25
2710 5 12	BLIND RIV.TRUSS-HD AL/ST 5X12	25
2710 5 16	BLIND RIV.TRUSS-HD AL/ST 5X16	25
2722 1	HAND RIVET GUN MFX150B	1
5500 33	TWIST DRILL 338 ROLL F. 3.3	1
5500 42	TWIST DRILL 338 ROLL F. 4.2	1
5500 50	TWIST DRILL 338 ROLL F. 5.0	1
9008 1	VAROIBOXX EMPTY	1
9008 1 14	VAROIBOXX THERMOF.INS.14COMP.	1

Article No.	Article Description	QTY
9007 2710	VAROIBOXX BL.RIV.TR.HD AL/ST.	1



Blind Riv.w.Mushr.Hd A2/A2 **VARO iBOXX**

- 504 pieces
- 1 × Art. No. 2722 1: hand rivet gun MFX 150 B

Contents

Article No.	Article Description	Quantity
2715 3 6	BLIND RIVET TRUSS-HEAD 3X6	50
2715 3 8	BLIND RIVET TRUSS-HEAD 3X8	50
2715 3 10	BLIND RIVET TRUSS-HEAD 3X10	50
2715 32 6	BLIND RIVET TRUSS-HEAD 3.2X6	50
2715 32 8	BLIND RIVET TRUSS-HEAD 3.2X8	50
2715 32 9	BLIND RIVET TRUSS-HEAD 3.2X10	50
2715 32 12	BLIND RIVET TRUSS-HEAD 3.2X12	50
2715 4 6	BLIND RIVET TRUSS-HEAD 4X6	50
2715 4 8	BLIND RIVET TRUSS-HEAD 4X8	50
2715 4 10	BLIND RIVET TRUSS-HEAD 4X10	50
2715 4 12	BLIND RIVET TRUSS-HEAD 4X12	50
2715 4 15	BLIND RIVET TRUSS-HEAD 4X16	50
2722 1	HAND RIVET GUN MFX150B	1
5500 31	TWIST DRILL 338 ROLL F. 3.1	1
5500 33	TWIST DRILL 338 ROLL F. 3.3	1
5500 42	TWIST DRILL 338 ROLL F. 4.2	1
9008 1	VAROIBOXX EMPTY	1
9008 1 14	VAROIBOXX THERMOF.INS.14COMP.	1

Article No.	Article Description	QTY
9007 2715	VAROIBOXX BL.RIV.TR.HD A2/A2	1



Blind Rivet w. Lg.Mushr.Hd AL/St, 14 mm

VAROIBOXX

- 501 pieces
- 1 × Art. No. 2722 1: hand rivet gun MFX 150 B

Contents

Article No.	Article Description	Quantity
2706 5 10	BLIND RIVET AL/ST 5X10	100
2706 5 12	BLIND RIVET AL/ST 5X12	100
2706 5 14	BLIND RIVET AL/ST 5X14	100
2706 5 16	BLIND RIVET AL/ST 5X16	100
2706 5 18	BLIND RIVET AL/ST 5X18	50
2706 5 20	BLIND RIVET AL/ST 5X21	50
2722 1	HAND RIVET GUN MFX150B	1
9008 1	VAROIBOXX EMPTY	1
9008 1 7	VAROIBOXX THERMOF.INS.7COMP.	1

Article No.	Article Description	QTY
9007 2706	VAROIBOXX BL.RI.TR.HD 14MM	1



Bl.Pop Riv.w.Mushr.Head AL/St. **VAROiBOXX**

- 301 pieces
- 1 × Art. No. 2722 1: hand rivet gun MFX 150 B

Contents

Article No.	Article Description	Quantity
2718 32 8	CLOSED END BLIND RIVET 3.2X8	50
2718 32 95	CLOSED END BLIND RIVET 3.2X9.5	50
2718 4 8	CLOSED END BLIND RIVET 4X8	50
2718 4 95	CLOSED END BLIND RIVET 4X9.5	50
2718 48 125	CLOSED END BLIND RIV. 4.8X12.5	50
2718 48 16	CLOSED END BLIND RIVET 4.8X16	50
2722 1	HAND RIVET GUN MFX150B	1
9008 1	VAROiBOXX EMPTY	1
9008 1 7	VAROiBOXX THERMOF.INS.7COMP.	1

Article No.	Article Description	QTY
9007 2718	VAROiBOXX CL.END BL.RIV.AL/ST	1



Closed E.Bl.Pop Riv.w.Mushr.Hd AL/A2 **VAROiBOXX**

- 529 pieces
- 1 × Art. No. 2722 1: hand rivet gun MFX 150 B

Contents

Article No.	Article Description	Quantity
2722 1	HAND RIVET GUN MFX150B	1
2723 32 65	CLOSED END BLIND RIVET 3.2X 6	50
2723 32 8	CLOSED END BLIND RIVET 3.2X 8	50
2723 32 95	CLOSED END BLIND RIVET 3.2X9.5	50
2723 32 11	CLOSED END BLIND RIVET 3.2X 11	50
2723 4 95	CLOSED END BLIND RIVET 4X 9.5	50
2723 4 11	CLOSED END BLIND RIVET 4X11	50
2723 48 95	CLOSED END BLIND RIVET 4.8X9.5	50
2723 48 11	CLOSED END BLIND RIVET 4.8X11	50
2723 48 125	CLOSED END BLIND RIVET 4.8X12.5	50
2723 48 14	CLOSED END BLIND RIVET 4.8X14	25
2723 48 16	CLOSED END BLIND RIVET 4.8X16	25
2723 48 21	CLOSED END BLIND RIVET 4.8X21	25
5500 33	TWIST DRILL 338 ROLL F. 3.3	1
5500 42	TWIST DRILL 338 ROLL F. 4.2	1
5500 50	TWIST DRILL 338 ROLL F. 5.0	1
9008 1	VAROiBOXX EMPTY	1
9008 1 14	VAROiBOXX THERMOF.INS.14COMP.	1

Article No.	Article Description	QTY
9007 2723	VAROiBOXX CL.END BL.RIV.AL/A2	1



Multiple Range Blind Riv. **VAROiBOXX**

- 529 pieces
- 1 x Art. No. 2722 1: hand rivet gun MFX 150 B

Contents

Article No.	Article Description	Quantity
2722 1	HAND RIVET GUN MFX150B	1
2730 32 8	FRK-MB-BLINDN. AL/ST 3,2X 8	50
2730 32 95	BLIND RIVET TRUSS-HEAD 3.2X9.5	50
2730 32 111	BLIND RIVET TRUSS-HD 3.2X11.1	50
2730 4 95	BLIND RIVET TRUSS HEAD 4X9.5	50
2730 4 127	BLIND RIVET TRUSS-HEAD 4X12	50
2730 4 16	BLIND RIVET TRUSS-HEAD 4X16	50
2730 48 103	BLIND RIVET TRUSS-HEAD 4.8X10	50
2730 48 17	BLIND RIVET TRUSS-HEAD 4.8X17	50
2730 48 248	BLIND RIVET TRUSS-HEAD 4.8X24.8	50
2731 4 11	BLIND RIVET COUNTERSUNK 4X11.1	25
2731 48 10	BLIND RIVET COUNTERSUNK 4.8X10	25
2731 48 16	BLIND RIVET COUNTERSUNK 4.8X16	25
5500 33	TWIST DRILL 338 ROLL F. 3.3	1
5500 42	TWIST DRILL 338 ROLL F. 4.2	1
5500 50	TWIST DRILL 338 ROLL F. 5.0	1
9008 1	VAROIBOXX EMPTY	1
9008 1 14	VAROIBOXX THERMOF.INS.14COMP.	1



Article No.	Article Description	QTY
9007 273	VAROIBOXX BLIND RIVETS ALU	1

Blind Riv.Nuts,Aluminium **VAROiBOXX**

- 301 pieces
- 1 × Art. No. 2748 1: blind rivet nut pliers set BM 10

Contents

Article No.	Article Description	Quantity
2740 3 25	FH-BLIND RIV.NUT AL M 3-2.5	25
2740 3 35	FH-BLIND RIV.NUT AL M 3-3.5	25
2740 4 3	FH-BLIND RIV.NUT AL M 4-3	25
2740 4 45	FH-BLIND RIV.NUT AL M 4-4.5	25
2740 5 3	FH-BLIND RIV.NUT AL M 5-3	25
2740 5 55	FH-BLIND RIV.NUT AL M 5-5.5	50
2740 5 8	FH-BLIND RIV.NUT AL M 5-8	25
2740 6 3	FH-BLIND RIV.NUT AL M 6-2.5	25
2740 6 55	FH-BLIND RIV.NUT AL M 6-5.5	50
2740 6 8	FH-BLIND RIV.NUT AL M 6-8	25
2748 1 0	BLIND RIV.NUT PL.SET MFX 306S	1
9008 1	VAROIBOXX EMPTY	1
9008 1 14	VAROIBOXX THERMOF.INS.14COMP.	1

Article No.	Article Description	QTY
9007 2740	VAROIBOXX BLIND RIVET NUTS ALU	1



Blind Rivet Nuts, Steel **VAROiBOXX**

- 301 pieces
- Flat head: 150 pieces
- Miniature countersunk head : 150 pieces
- 1 × Art. No. 2748 1: blind rivet nut pliers set BM 10
- **Steel**

Contents

Article No.	Article Description	Quantity
2742 4 3	FH-BLIN.RIV.NUT ST RIB.M 4-3	50
2742 5 3	FH-BLIN.RIV.NUT ST RIB.M 5-3	25
2742 5 55	FH-BLIN.RIV.NUT ST RIB.M 5-5.5	25
2742 6 3	FH-BLIN.RIV.NUT ST RIB.M 6-3	50
2744 4	MINI CSK RIVET NUT STEEL M4	25
2744 5	MINI CSK RIVET NUT STEEL M5	25
2744 6	MINI CSK RIVET NUT STEEL M6	25
2745 4	MINI CSK KN.BL.R.NUT ST.M4-2.5	25
2745 5	MINI CSK KN.BL.R.NUT ST.M 5-3	25
2745 6	MINI CSK KN.BL.R.NUT ST.M 6-3	25
2748 1 0	BLIND RIV.NUT PL.SET MFX 306S	1
9008 1	VAROIBOXX EMPTY	1
9008 1 14	VAROIBOXX THERMOF.INS.14COMP.	1

Article No.	Article Description	QTY
9007 274	VAROIBOXX BLIND RIV.NUTS COMBI	1



Cotter Pins DIN 94, gv **VAROIBOXX**

- 1,325 pieces
- Galvanised steel

Contents

Article No.	Article Description	Quantity
2801 1 20	SPLIT PIN 94 GA 1X20	200
2801 16 32	SPLIT PIN 94 GA 1.6X32	200
2801 2 32	SPLIT PIN 94 GA 2X32	200
2801 25 32	SPLIT PIN 94 GA 2.5X32	100
2801 25 40	SPLIT PIN 94 GA 2.5X40	100
2801 32 32	SPLIT PIN 94 GA 3.2X32	100
2801 32 50	SPLIT PIN 94 GA 3.2X50	100
2801 35 40	SPLIT PIN 94 GA 3.5X40	100
2801 4 40	SPLIT PIN 94 GA 4X40	100
2801 4 63	SPLIT PIN 94 GA 4X63	50
2801 5 50	SPLIT PIN 94 GA 5X50	50
2801 63 63	SPLIT PIN 94 GA 6.3X63	25
9008 1	VAROIBOXX EMPTY	1
9008 1 12	VAROIBOXX THERMOF.INS.12COMP.	1

Article No.	Article Description	QTY
9007 2801	VAROIBOXX COTTER PINS DIN94 GV	1



Spring Cotter Pins, gv **VAROiBOXX**

- 145 pieces
- Galvanised steel

Contents

Article No.	Article Description	Quantity
2811 3	R PIN SINGLE EYE ZINC M3	25
2811 4	R PIN SINGLE EYE ZINC M4	25
2811 5	R PIN SINGLE EYE ZINC M5	15
2811 6	R PIN SINGLE EYE ZINC M6	10
2812 3	R PIN TWIN EYE ZINC M3	40
2812 4	R PIN TWIN EYE ZINC M4	20
2812 5	R PIN TWIN EYE ZINC M5	10
9008 1	VAROiBOXX EMPTY	1
9008 1 8	VAROiBOXX THERMOF.INS.8COMP.	1

Article No.	Article Description	QTY
9007 281	VAROiBOXX SPRING COTTER PINS	1



Spring Type Straight Pins DIN 1481 **VAROiBOXX**

- 655 pieces
- Complies with ISO 8752
- Spring steel, polished

Contents

Article No.	Article Description	Quantity
2860 3 30	STRAIGHT PINS 1481 3X30	50
2860 3 40	STRAIGHT PINS 1481 3X40	50
2860 4 20	STRAIGHT PINS 1481 4X20	50
2860 4 30	STRAIGHT PINS 1481 4X30	50
2860 4 40	STRAIGHT PINS 1481 4X40	50
2860 4 50	STRAIGHT PINS 1481 4X50	50
2860 5 30	STRAIGHT PINS 1481 5X30	50
2860 5 40	STRAIGHT PINS 1481 5X40	50
2860 5 50	STRAIGHT PINS 1481 5X50	25
2860 6 30	STRAIGHT PINS 1481 6X30	50
2860 6 40	STRAIGHT PINS 1481 6X40	50
2860 6 50	STRAIGHT PINS 1481 6X50	25
2860 6 60	STRAIGHT PINS 1481 6X60	25
2860 8 40	STRAIGHT PINS 1481 8X40	25
2860 8 50	STRAIGHT PINS 1481 8X50	25
2860 8 60	STRAIGHT PINS 1481 8X60	10
2860 10 50	STRAIGHT PINS 1481 10X50	10
2860 10 60	STRAIGHT PINS 1481 10X60	10
9008 1	VAROiBOXX EMPTY	1
9008 1 18	VAROiBOXX THERMOF.INS.18COMP.	1

Article No.	Article Description	QTY
9007 2860	VAROiBOXX STRAIGHT PINS 1481	1



Hose Clamps W2 TORRO **VAROiBOXX**

- 360 parts
- Ribbon and enclosure stainless steel
- Screw galvanized steel

Contents

Article No.	Article Description	Quantity
3200 8 12	HOSE CL TOR 7.5MM SW6 W2 8-12	65
3200 8 16	HOSE CL TOR 9MM SW7 W2 8-16	105
3200 10 16	HOSE CL TOR 7.5MM SW6 W2 10-16	100
3200 12 20	HOSE CL TOR 9MM SW7 W2 12-22	40
3200 16 25	HOSE CL TOR 9MM SW7 W2 16-27	30
3200 20 32	HOSE CL TOR 9MM SW7 W2 20-32	20
9008 1	VAROIBOXX EMPTY	1
9008 1 12	VAROIBOXX THERMOF.INS.12COMP.	1

Article No.	Article Description	QTY
9007 3200	VAROIBOXX HOSE CLAMPS W2 TORRO	1



Cable Connectors, Insulated **VAROiBOXX**

- 526 pieces
- 1 x Art. No. 3790 11: crimping pliers ISO 900

Contents

Article No.	Article Description	Quantity
3700 901	CRIMP CNCTR-RED FEMALE 6,3 901	50
3700 902	CRIMP CNCTR-BLUE FEM.6.3MM 902	50
3700 905	CRIMP CNCTR-BLUE PIGGY BL6.3MM	25
3700 906	CRIMP CNCTR-RED FEMALE 4,8 906	50
3700 907	CRIMP CNCTR-RED FEMALE 2,8 907	50
3700 912	CRIMP CNCTR-RED RING M4 912	25
3700 916	CRIMP CNCTR-BLUE RING M5 916	25
3700 917	CRIMP CNCTR-BLUE RING M6 917	25
3700 936	CRIMP CNCTR-BLUE MALE 6,3 936	50
3700 937	CRIMP CNCTR-RED MALE 6,3 937	50
3700 939	CRIMP CNCTR-BLUE BUTT 939	50
3700 941	BUTT CONNECTOR RED 941	50
3701 957	CONNECTOR SNAP-ON BLUE 957	25
3790 11	CRIMP PLIERS INSULATED 900	1
9008 1	VAROIBOXX EMPTY	1
9008 1 14	VAROIBOXX THERMOF.INS.14COMP.	1

Article No.	Article Description	QTY
9007 3700	VAROIBOXX CABLE CONNECT.INSUL.	1



Heat-Shr.Cable Term.and Connec.**VAROiBOXX**

- 161 pieces
- 1 x Art. No. 3790 11: crimping pliers ISO 900

Contents

Article No.	Article Description	Quantity
3702 801	H SRNK QK CONN.FEMALE RED 6.3	10
3702 802	H SRNK QK CONN.FEMALE BLUE 6.3	10
3702 812	H SRNK RING TERMINAL RED M4	10
3702 813	H SRNK RING TERMINAL RED M5	10
3702 816	H SRNK RING TERMINAL BLUE M5	10
3702 817	H SRNK RING TERMINAL BLUE M6	10
3702 818	H SRNK RING TERMINAL BLUE M8	10
3702 833	H SRNK RING TERMINAL RED M6	10
3702 836	H SRNK QK CONN.MALE BLUE 6.3	10
3702 837	H SRNK QK CONN.MALE RED 6.3	10
3702 839	H SRNK BUTT CONNECT.BLUE 839	30
3702 840	H SRNK BUTT CONNECT.YELLOW 840	10
3702 841	H SRNK BUTT CONNECT.RED 841	20
3790 11	CRIMP PLIERS INSULATED 900	1
9008 1	VAROiBOXX EMPTY	1
9008 1 14	VAROiBOXX THERMOF.INS.14COMP.	1

Article No.	Article Description	QTY
9007 3702	VAROiBOXX HEAT-SHRINK CONNECT.	1



Multicore Cable Ends **VAROiBOXX**

- Insulated / uninsulated = 901 pieces

Contents

Article No.	Article Description	Quantity
3711 15 7	CBL END SLEEVE UNINSUL. 1.5X7	100
3711 15 12	CBL END SLEEVE UNINSUL. 1.5X12	100
3711 25 7	CBL END SLEEVE UNINSUL. 2.5X7	100
3711 25 12	CBL END SLEEVE UNINSUL. 2.5X12	100
3711 4 12	CBL END SLEEVE UNINSULAT. 4X12	100
3711 6 15	CBL END SLEEVE UNINSULAT. 6X15	100
3713 05 155	CBL END SLEEVE 0.5HL WHITE	50
3713 075 14	CBL END SLE.ISO.DIN 0.75N GREY	50
3713 4 168	CBL END SLEEVE 4N GREY	25
3713 6 20	CBL END SLEEVE 6N YELLOW	25
3713 1 14	CBL END SLE.ISO.DIN/B 1N RED	50
3713 15 14	CBL END SLE.ISO.DIN/B 1.5N BLA	50
3713 25 15	CBL END SLE.ISO.DIN/A 2.5NBLUE	50
3790 4	MULTICORE CABLE END PLIERS 143	1
9008 1	VAROiBOXX EMPTY	1
9008 1 14	VAROiBOXX THERMOF.INS.14COMP.	1

Article No.	Article Description	QTY
9007 371	VAROiBOXX MULTIC.CABLE ENDS	1



Heat Shrink Tubing **VARO iBOXX**

- 120 pieces
- **Shrinking rate2:1**
- For cable and connector insulation as well as for bundling cables
- Protects against corrosion and mechanical influences e.g. in form of buckling protection and strain relief
- Modified polyethylene, irradiation cross-linked
- Colour: black
- Dielectric strength in compliance with VDE 0303, part 2: 20 KV/mm Min.
- Dielectric constant in compliance with DIN 53483, Bl. 2 + 3 : 2,5 max.
- Self-extinguishing
- Application temperatures: -55 °C up to +125 °C
- Spec. volume resistance according to VDE 0303, part 3: 1014 Ohm x cm Min.



Contents

Article No.	Article Description	Quantity
3731 24	HEAT SHRINK TUBE 100MM 2.4	25
3731 32	HEAT SHRINK TUBE 100MM 3.2	25
3731 48	HEAT SHRINK TUBE 100MM 4.8	20
3731 64	HEAT SHRINK TUBE 100MM 6.4	15
3731 95	HEAT SHRINK TUBE 100MM 9.5	15
3731 127	HEAT SHRINK TUBE 100MM 12.7	10
3731 190	HEAT SHRINK TUBE 100MM 19.0	5
3731 254	HEAT SHRINK TUBE 100MM 25.4	5
9008 1	VAROIBOXX EMPTY	1
9008 1 8	VAROIBOXX THERMOF.INS.8COMP.	1

Article No.	Article Description	QTY
9007 3731	VAROIBOXX HEAT SHRINK TUBE 2:1	1

Heat-Shrink Tubing 3:1, Butt Connect. **VARO iBOXX**

- 125 pieces

Contents

Article No.	Article Description	Quantity
3702 839	H SRNK BUTT CONNECT.BLUE 839	30
3702 840	H SRNK BUTT CONNECT.YELLOW 840	20
3702 841	H SRNK BUTT CONNECT.RED 841	20
3733 3	HEAT SHRINK TUBING IK 100MM3/1	20
3733 6	HEAT SHRINK TUBING IK 100MM6/2	10
3733 9	HEAT SHRINK TUBING IK 100MM9/3	10
3733 12	HEAT SHRINK TUBING IK100MM12/4	10
3733 19	HEAT SHRINK TUBING IK100MM19/6	5
9008 1	VAROIBOXX EMPTY	1
9008 1 8	VAROIBOXX THERMOF.INS.8COMP.	1

Article No.	Article Description	QTY
9007 3733	VAROIBOXX HEAT SHR.TU.3:1 IK	1



Bit Assortment PH/PZ/TX **FORCH** ***** **VAROiBOXX**

- Assortment in high quality VAROiBOXX
- Professional quality bits with colour-coding system
- Toughened bits for hard screw-joints
- **Contents: 300 bits**

Contents

Article No.	Article Description	Quantity
4311 5 1	1/4"PH-BIT 25MM SZ.1 YELLOW 5*	10
4311 5 2	1/4"PH-BIT 25MM SZ.2 WHITE 5*	10
4311 5 3	1/4"PH-BIT 25MM SZ.3 RED 5*	10
4312 5 1	1/4"PZ-BIT 25MM SZ.1 BLUE 5*	20
4312 5 2	1/4"PZ-BIT 25MM SZ.2 BLACK 5*	30
4312 5 3	1/4"PZ-BIT 25MM SZ.3 GREEN 5*	10
4314 5 10	1/4"BIT 25MM TX10 BLUE 5*	20
4314 5 15	1/4"BIT 25MM TX15 YELLOW 5*	20
4314 5 20	1/4"BIT 25MM TX20 WHITE 5*	40
4314 5 25	1/4"BIT 25MM TX25 BLACK 5*	50
4314 5 30	1/4"BIT 25MM TX30 RED 5*	50
4314 5 40	1/4"BIT 25MM TX40 GREY 5*	30
9004 1 5 10	INS.BOX YELL.5X10CM VAROBOXX 1	1
9004 1 10 10	INS.BOX BLUE10X10CM VAROBOXX 1	2
9008 1	VAROIBOXX EMPTY	1
9008 75 260	VAROIBOXX INSET.B.GREY7.5X26MM	3
9008 75 260 1	PART.INSERT BOX GREY VARIOBOXX	6



Article No.	Article Description	QTY
9007 4314	VAROIBOXX 1/4"BITS TX/PZ/PH 5*	1

Permanent Marker **VAROiBOXX**

- 50 pieces

Contents

Article No.	Article Description	Quantity
4713 10 2	PERM.MARKER RETRACT11 RED1.5-3	5
4713 10 3	PER.MARKER RETRACT11 BLUE1.5-3	5
4713 10 4	PER.MARKER RETRACT11GREEN1.5-3	5
4713 10 5	PER.MARKER RETRACT11BLACK1.5-3	10
4713 11 2	PERMANENT MARKER RED 1MM	5
4713 11 3	PERMANENT MARKER BLUE 1MM	5
4713 11 4	PERMANENT MARKER GREEN 1MM	5
4713 11 5	PERMANENT MARKER BLACK 1MM	10
9008 1	VAROIBOXX EMPTY	1
9008 1 4	VAROIBOXX THERMOF.INS.4COMP.	1

Article No.	Article Description	QTY
9007 4713 1	VAROIBOXX PERMANENT MARKER	1



Measuring Equipment **VARO iBOXX**

- 1x Art. No. 3791 24 1000: AC voltage tester
- 1x Art. No. 4716 18: Laser range finder F-EM 18
- 1x Art. No. 4716 11: Detector Profi Plus

Contents

Article No.	Article Description	Quantity
3791 24 1000	VOLTAGE TESTER AC	1
4716 11	DETECTOR PROFI PLUS	1
4716 18	LASER DISTANCE METER-F-EM18	1
9008 1	VAROIBOXX EMPTY	1
9008 4716 1	FOAM-INS.MEASUREMENT	1

Article No.	Article Description	QTY
9007 4716 1	MEASURING EQUIPM.LASERLINER 1	1



Cutterknife with Blades **VARO iBOXX**

- 210 parts

Contents

Article No.	Article Description	Quantity
4762 18 3	CUTTERKNIFE 18MM	10
4762 40 100	PK(100)RET.BLA.TYPE1 PROF.18MM	2
9008 1	VAROIBOXX EMPTY	1
9008 1 4	VAROIBOXX THERMOF.INS.4COMP.	1

Article No.	Article Description	QTY
9007 4762	VAROIBOX CUTTERKNIFE + BLADES	1



Tw.Drill DIN 338 HSS, Roll Forged Type N **VAROIBOXX**

- 135 pieces
- Cylindrical, short
- Right-hand cutting
- Conical cut
- Point angle 118°

Contents

Article No.	Article Description	Quantity
5500 10	TWIST DRILL 338 ROLL F. 1.0	10
5500 15	TWIST DRILL 338 ROLL F. 1.5	10
5500 20	TWIST DRILL 338 ROLL F. 2.0	10
5500 25	TWIST DRILL 338 ROLL F. 2.5	10
5500 30	TWIST DRILL 338 ROLL F. 3.0	10
5500 35	TWIST DRILL 338 ROLL F. 3.5	10
5500 40	TWIST DRILL 338 ROLL F. 4.0	10
5500 45	TWIST DRILL 338 ROLL F. 4.5	10
5500 50	TWIST DRILL 338 ROLL F. 5.0	10
5500 55	TWIST DRILL 338 ROLL F. 5.5	5
5500 60	TWIST DRILL 338 ROLL F. 6.0	10
5500 65	TWIST DRILL 338 ROLL F. 6.5	5
5500 70	TWIST DRILL 338 ROLL F. 7.0	5
5500 75	TWIST DRILL 338 ROLL F. 7.5	5
5500 80	TWIST DRILL 338 ROLL F. 8.0	5
5500 85	TWIST DRILL 338 ROLL F. 8.5	2
5500 90	TWIST DRILL 338 ROLL F. 9.0	2
5500 95	TWIST DRILL 338 ROLL F. 9.5	2
5500 100	TWIST DRILL 338 ROLL F. 10.0	2
5500 105	TWIST DRILL 338 ROLL F. 10.5	2
9008 1	VAROIBOXX EMPTY	1
9008 1 20	VAROIBOXX THERMOF.INS.20COMP.	1



Article No.	Article Description	QTY
9007 5500	VAROIBOXX TW.DR.338 ROLL FORG.	1

Tw.Drill DIN 338 HSS Ground, Type N **VAROIBOXX**

- 155 pieces
- Cylindrical, short
- Right-hand cutting
- Split point (from Ø 3 mm)
- Point angle 135°
- For maximum precision

Contents

Article No.	Article Description	Quantity
5501 10	TWIST DRILL 338 GROUND 1.0	10
5501 15	TWIST DRILL 338 GROUND 1.5	10
5501 20	TWIST DRILL 338 GROUND 2.0	10
5501 25	TWIST DRILL 338 GROUND 2.5	10
5501 30	TWIST DRILL 338 GROUND 3.0	10
5501 35	TWIST DRILL 338 GROUND 3.5	10
5501 40	TWIST DRILL 338 GROUND 4.0	10
5501 45	TWIST DRILL 338 GROUND 4.5	10
5501 50	TWIST DRILL 338 GROUND 5.0	10
5501 55	TWIST DRILL 338 GROUND 5.5	10
5501 60	TWIST DRILL 338 GROUND 6.0	10
5501 65	TWIST DRILL 338 GROUND 6.5	5
5501 70	TWIST DRILL 338 GROUND 7.0	5
5501 75	TWIST DRILL 338 GROUND 7.5	5
5501 80	TWIST DRILL 338 GROUND 8.0	5
5501 85	TWIST DRILL 338 GROUND 8.5	5
5501 90	TWIST DRILL 338 GROUND 9.0	5
5501 95	TWIST DRILL 338 GROUND 9.5	5
5501 100	TWIST DRILL 338 GROUND 10.0	5
5501 105	TWIST DRILL 338 GROUND 10.5	5
9008 1	VAROIBOXX EMPTY	1
9008 1 20	VAROIBOXX THERMOF.INS.20COMP.	1



Article No.	Article Description	QTY
9007 5501	VAROIBOXX TW.DR.338 GROUND	1

Tw.Drill 338 HSS-E,Ground Type N **VAROiBOXX**

• 143 pieces

Contents

Article No.	Article Description	Quantity
5502 10	TWIST DRILL 338 HSS-E-CO 1.0	10
5502 15	TWIST DRILL 338 HSS-E-CO 1.5	10
5502 20	TWIST DRILL 338 HSS-E-CO 2.0	10
5502 25	TWIST DRILL 338 HSS-E-CO 2.5	10
5502 30	TWIST DRILL 338 HSS-E-CO 3.0	10
5502 35	TWIST DRILL 338 HSS-E-CO 3.5	10
5502 40	TWIST DRILL 338 HSS-E-CO 4.0	10
5502 45	TWIST DRILL 338 HSS-E-CO 4.5	10
5502 50	TWIST DRILL 338 HSS-E-CO 5.0	10
5502 55	TWIST DRILL 338 HSS-E-CO 5.5	10
5502 60	TWIST DRILL 338 HSS-E-CO 6.0	10
5502 65	TWIST DRILL 338 HSS-E-CO 6.5	5
5502 70	TWIST DRILL 338 HSS-E-CO 7.0	5
5502 75	TWIST DRILL 338 HSS-E-CO 7.5	5
5502 80	TWIST DRILL 338 HSS-E-CO 8.0	5
5502 85	TWIST DRILL 338 HSS-E-CO 8.5	5
5502 90	TWIST DRILL 338 HSS-E-CO 9.0	2
5502 95	TWIST DRILL 338 HSS-E-CO 9.5	2
5502 100	TWIST DRILL 338 HSS-E-CO 10.0	2
5502 105	TWIST DRILL 338 HSS-E-CO 10.5	2
9008 1	VAROiBOXX EMPTY	1
9008 1 20	VAROiBOXX THERMOF.INS.20COMP.	1



Article No.	Article Description	QTY
9007 5502	VAROiBOXX TW.DR.338 HSS-E-CO	1

Tw.Drill 338 HSS-TIN,Ground Type N **VAROiBOXX**

• 140 pieces

Contents

Article No.	Article Description	Quantity
5503 10	TWIST DRILL 338 TITANIUM 1.0	10
5503 15	TWIST DRILL 338 TITANIUM 1.5	10
5503 20	TWIST DRILL 338 TITANIUM 2.0	10
5503 25	TWIST DRILL 338 TITANIUM 2.5	10
5503 30	TWIST DRILL 338 TITANIUM 3.0	10
5503 35	TWIST DRILL 338 TITANIUM 3.5	10
5503 40	TWIST DRILL 338 TITANIUM 4.0	10
5503 45	TWIST DRILL 338 TITANIUM 4.5	10
5503 50	TWIST DRILL 338 TITANIUM 5.0	10
5503 55	TWIST DRILL 338 TITANIUM 5.5	10
5503 60	TWIST DRILL 338 TITANIUM 6.0	10
5503 65	TWIST DRILL 338 TITANIUM 6.5	5
5503 70	TWIST DRILL 338 TITANIUM 7.0	5
5503 75	TWIST DRILL 338 TITANIUM 7.5	5
5503 80	TWIST DRILL 338 TITANIUM 8.0	5
5503 85	TWIST DRILL 338 TITANIUM 8.5	2
5503 90	TWIST DRILL 338 TITANIUM 9.0	2
5503 95	TWIST DRILL 338 TITANIUM 9.5	2
5503 100	TWIST DRILL 338 TITANIUM 10.0	2
5503 105	TWIST DRILL 338 TITANIUM 10.5	2
9008 1	VAROiBOXX EMPTY	1
9008 1 20	VAROiBOXX THERMOF.INS.20COMP.	1



Article No.	Article Description	QTY
9007 5503	VAROiBOXX TW.DR.338 TITAN	1

Tw.Drill HSSE-E, MULTI-INOX **VAROiBOXX**

- 62 pieces
- 5 % cobalt alloy
- Ideal for use in hand-guided machines
- Minimised effort due to improved geometry of the cut
- Improved drilling speed
- Pinpoint accuracy when drilling, no centre-punches needed
- Precise drilling behaviour and improved long-term accuracy
- Outstanding fracture resistance due to optimum elasticity and geometry
- 3-edged shaft prevents skidding in the drill chuck due to force-fit connection
- Reduced war on the drill chuck
- Optimum power transmission from the shaft to the tip
- 40° angle of twist guarantees efficient chip removal
- Right-handed cutting
- DIN 338 short cylindrical
- Split point from Ø 3 mm
- Point angle 135°
- 3-edged shaft from Ø 4 mm

Contents

Article No.	Article Description	Quantity
5506 5 10	TWIST DRILL 338 MULTI-INOX 1.0	4
5506 5 15	TWIST DRILL 338 MULTI-INOX 1.5	4
5506 5 20	TWIST DRILL 338 MULTI-INOX 2.0	4
5506 5 25	TWIST DRILL 338 MULTI-INOX 2.5	4
5506 5 30	TWIST DRILL 338 MULTI-INOX 3.0	4
5506 5 35	TWIST DRILL 338 MULTI-INOX 3.5	4
5506 5 40	TWIST DRILL 338 MULTI-INOX 4.0	4
5506 5 45	TWIST DRILL 338 MULTI-INOX 4.5	4
5506 5 50	TWIST DRILL 338 MULTI-INOX 5.0	4
5506 5 55	TWIST DRILL 338 MULTI-INOX 5.5	4
5506 5 60	TWIST DRILL 338 MULTI-INOX 6.0	4
5506 5 65	TWIST DRILL 338 MULTI-INOX 6.5	2
5506 5 70	TWIST DRILL 338 MULTI-INOX 7.0	2
5506 5 75	TWIST DRILL 338 MULTI-INOX 7.5	2
5506 5 80	TWIST DRILL 338 MULTI-INOX 8.0	2
5506 5 85	TWIST DRILL 338 MULTI-INOX 8.5	2
5506 5 90	TWIST DRILL 338 MULTI-INOX 9.0	2
5506 5 95	TWIST DRILL 338 MULTI-INOX 9.5	2
5506 5 100	TWIST DRILL 338 MULTI-INOX 10.0	2
5506 5 105	TWIST DR. 338 MULTI-INOX 10.5	2
9008 1	VAROiBOXX EMPTY	1
9008 1 20	VAROiBOXX THERMOF.INS.20COMP.	1



Article No.	Article Description	QTY
9007 5506 5	VAROiBOXX T.DR338MULTI-INOX5*	1

Tw.Drill DIN 340 HSS,Ground,Type N **VAROiBOXX**

• 67 pieces

Contents

Article No.	Article Description	Quantity
5510 30	TWIST DRILL LONG 340 3.0	10
5510 35	TWIST DRILL LONG 340 3.5	10
5510 40	TWIST DRILL LONG 340 4.0	10
5510 50	TWIST DRILL LONG 340 5.0	10
5510 60	TWIST DRILL LONG 340 6.0	10
5510 65	TWIST DRILL LONG 340 6.5	5
5510 70	TWIST DRILL LONG 340 7.0	5
5510 80	TWIST DRILL LONG 340 8.0	5
5510 100	TWIST DRILL LONG 340 10.0	2
9008 1	VAROiBOXX EMPTY	1
9008 1 9	VAROiBOXX THERMOF.INS.9COMP.	1

Article No.	Article Description	QTY
9007 5510	VAROiBOXX TWIST DRILL 340LONG	1



Tw.Drill HSSE-E,STEAM **VARO iBOXX**

- 62 pieces
- Universal drill for use in the automotive industry, repair shops, building services and industry
- Suitable for use in controlled, stationary CNC-controlled and hand-guided machines
- Pinpoint accuracy when drilling, no centre-punches
- Increased service life due to improved geometry and cutting stability
- Precise drilling behaviour and improved long-term accuracy
- Outstanding fracture resistance due to optimum elasticity
- Reduced chuck wear due to hardened shaft
- 38° angle of twist guarantees efficient chip removal
- Low feed and cutting forces
- 5% cobalt alloy
- Surface hardened by vapour tempering
- Optimum drilling depth 3x drill Ø
- Right-hand cutting
- DIN 388 short cylindrical
- Split point from Ø 1 mm
- Point angle 118 °

Contents

Article No.	Article Description	Quantity
5566 5 10	TW.DR.338 HSS-E STEAM 1.0 5*	4
5566 5 15	TW.DR.338 HSS-E STEAM 1.5 5*	4
5566 5 20	TW.DR.338 HSS-E STEAM 2.0 5*	4
5566 5 25	TW.DR.338 HSS-E STEAM 2.5 5*	4
5566 5 30	TW.DR.338 HSS-E STEAM 3.0 5*	4
5566 5 35	TW.DR.338 HSS-E STEAM 3.5 5*	4
5566 5 40	TW.DR.338 HSS-E STEAM 4.0 5*	4
5566 5 45	TW.DR.338 HSS-E STEAM 4.5 5*	4
5566 5 50	TW.DR.338 HSS-E STEAM 5.0 5*	4
5566 5 55	TW.DR.388 HSS-E STEAM 5.5 5*	4
5566 5 60	TW.DR.388 HSS-E STEAM 6.0 5*	4
5566 5 65	TW.DR.338 HSS-E STEAM 6.5 5*	2
5566 5 70	TW.DR.338 HSS-E STEAM 7.0 5*	2
5566 5 75	TW.DR.338 HSS-E STEAM 7.5 5*	2
5566 5 80	TW.DR.338 HSS-E STEAM 8.0 5*	2
5566 5 85	TW.DR.338 HSS-E STEAM 8.5 5*	2
5566 5 90	TW.DR.338 HSS-E STEAM 9.0 5*	2
5566 5 95	TW.DR.338 HSS-E STEAM 9.5 5*	2
5566 5 100	TW.DR.338 HSS-E STEAM 10.0 5*	2
5566 5 105	TW.DR.338 HSS-E STEAM 10.5 5*	2
9008 1	VAROIBOXX EMPTY	1
9008 1 20	VAROIBOXX THERMOF.INS.20COMP.	1



Article No.	Article Description	QTY
9007 5566 5	VAROIBOXX TW.DR.388HSS-E ST 5*	1

Hammer Dr. with SDS-plus TRIAL **VAROiBOXX**



- 25 pieces

Contents

Article No.	Article Description	Quantity
5402 3 10	P(10PAIRS)EAR PLUGS SZ.S	1
5613 6 160	SDS+HA-DR TRIAL 6X160/100 5*	3
5613 6 260	SDS+HA-DR TRIAL 6X260/200 5*	3
5613 8 160	SDS+HA-DR TRIAL 8X160/100 5*	3
5613 8 260	SDS+HA-DR TRIAL 8X260/200 5*	3
5613 10 160	SDS+HA-DR TRIAL 10X160/100 5*	3
5613 10 260	SDS+HA-DR TRIAL 10X260/200 5*	3
5613 12 160	SDS+HA-DR TRIAL 12X160/100 5*	3
5613 12 260	SDS+HA-DR TRIAL 12X260/200 5*	3
9008 1	VAROiBOXX EMPTY	1
9008 1 9	VAROiBOXX THERMOF.INS.9COMP.	1

Article No.	Article Description	QTY
9007 5613 1	VAROiBOXX SDS+HA-DR TRIAL 5*	1



Hammer Dr./Chisel with SDS-plus **VAROiBOXX**



- 21 pieces

Contents

Article No.	Article Description	Quantity
5402 3 10	P(10PAIRS)EAR PLUGS SZ.S	1
5613 6 160	SDS+HA-DR TRIAL 6X160/100 5*	3
5613 8 160	SDS+HA-DR TRIAL 8X160/100 5*	3
5613 10 160	SDS+HA-DR TRIAL 10X160/100 5*	3
5613 12 160	SDS+HA-DR TRIAL 12X160/100 5*	3
5613 14 210	SDS+HA-DR TRIAL 14X210/150 5*	3
5613 16 210	SDS+HA-DR TRIAL 16X210/150 5*	3
5654 250 5	SDS-PLUS POINTED CHISEL 250 5*	1
5654 20 250 5	SDS-PLUS FLAT CHISEL 20X250 5*	1
9008 1	VAROiBOXX EMPTY	1
9008 1 9	VAROiBOXX THERMOF.INS.9COMP.	1

Article No.	Article Description	QTY
9007 5613 2	VAROiBOXX SDS+HA-DR TRIAL 2 5*	1



Hammer Drill SDS-plus DUAL 4W **VAROiBOXX**

• 27 pieces

Contents

Article No.	Article Description	Quantity
5402 3 10	P(10PAIRS)EAR PLUGS SZ.S	1
5614 6 160	SDS+HADR-DUAL 4W 6 X 160/100	3
5614 6 260	SDS+HADR-DUAL 4W 6 X 260/200	3
5614 8 160	SDS+HADR-DUAL 4W 8 X 160/100	3
5614 8 260	SDS+HADR-DUAL 4W 8 X 260/200	3
5614 10 160	SDS+HADR-DUAL 4W 10 X 160/100	3
5614 10 260	SDS+HADR-DUAL 4W 10 X 260/200	3
5614 12 160	SDS+HADR-DUAL 4W 12 X 160/100	3
5614 12 260	SDS+HADR-DUAL 4W 12 X 260/200	3
9008 1	VAROIBOXX EMPTY	1
9008 1 9	VAROIBOXX THERMOF.INS.9COMP.	1

Article No.	Article Description	QTY
9007 5614 1	VAROIBOXX SDS-HA.DR.DUAL 4W 1	1



Nylon Expansion Anchors **VAROiBOXX**

- Range in VAROiBOXX
- Set contains 650 nylon expansion anchors in 4 different sizes

Contents

Article No.	Article Description	Quantity
8000 6	NYLON-EXPANSION ANCHOR F 6	200
8000 8	NYLON-EXPANSION ANCHOR F 8	250
8000 10	NYLON-EXPANSION ANCHOR F 10	150
8000 12	NYLON-EXPANSION ANCHOR F 12	50
9004 1 10 10	INS.BOX BLUE10X10CM VAROBOXX 1	1
9004 1 10 15	INSETB.L-GR.10X15CM VAROBOXX 1	1
9008 1	VAROIBOXX EMPTY	1
9008 75 260	VAROIBOXX INSET.B.GREY7.5X26MM	3
9008 75 260 1	PART.INSERT BOX GREY VARIOBOXX	1

Article No.	Article Description	QTY
9007 8000	NYLON EXPANSION ANCH.VARIOBOXX	1



All-Purpose Anchors **VAROiBOXX**

- Range in VAROiBOXX
- Set contains 650 all-purpose anchors in 4 different sizes

Contents

Article No.	Article Description	Quantity
8100 6	ALL-PURPOSE PLUG 6	300
8100 8	ALL-PURPOSE PLUG 8	200
8100 10	ALL-PURPOSE PLUG 10	100
8100 12	ALL-PURPOSE PLUG 12	50
9004 1 10 10	INS.BOX BLUE10X10CM VAROBOXX 1	1
9004 1 10 15	INSETB.L-GR.10X15CM VAROBOXX 1	1
9008 1	VAROIBOXX EMPTY	1
9008 75 260	VAROIBOXX INSET.B.GREY7.5X26MM	3

Article No.	Article Description	QTY
9007 8100	ALL-PURPOSE ANCHORS VARIOBOXX	1



All-Purpose Anchors with Collars **VAROiBOXX**

- Range in VAROiBOXX
- Set contains 550 all-purpose anchors with collars in 4 different sizes

Contents

Article No.	Article Description	Quantity
8101 6	ALL-PURPOSE PLUG/FLANGE 6	300
8101 8	ALL-PURPOSE PLUG/FLANGE 8	100
8101 10	ALL-PURPOSE PLUG/FLANGE 10	100
8101 12	ALL-PURPOSE PLUG/FLANGE 12	50
9004 1 10 10	INS.BOX BLUE10X10CM VAROBOXX 1	1
9004 1 10 15	INSETB.L-GR.10X15CM VAROBOXX 1	1
9008 1	VAROIBOXX EMPTY	1
9008 75 260	VAROIBOXX INSET.B.GREY7.5X26MM	3

Article No.	Article Description	QTY
9007 8101	ALL-PURP.ACHN.W.COLL.VARIOBOXX	1



Universal Anchors GX Premium **VAROiBOXX**

- Range in VAROiBOXX
- Set contains 650 universal anchors in 4 different sizes

Contents

Article No.	Article Description	Quantity
8108 6	UNIVERSAL PLUG GX PREMIUM 6MM	300
8108 8	UNIVERSAL PLUG GX PREMIUM 8MM	200
8108 10	UNIVERSAL PLUG GX PREMIUM 10MM	100
8108 12	UNIVERSAL PLUG GX PREMIUM 12MM	50
9004 1 10 10	INS.BOX BLUE10X10CM VAROBOXX 1	1
9004 1 10 15	INSETB.L-GR.10X15CM VAROBOXX 1	1
9008 1	VAROIBOXX EMPTY	1
9008 75 260	VAROIBOXX INSET.B.GREY7.5X26MM	3

Article No.	Article Description	QTY
9007 8108	UNIVER.ACHN.GX PREM.VARIOBOXX	1



TRI All-Purpose Anchors **VAROiBOXX**

- Range in VAROiBOXX
- Set contains 650 TRI all-purpose anchors in 4 different sizes

Contents

Article No.	Article Description	Quantity
8112 6	TRI ALL PURP.ANCHORS 6X36	300
8112 8	TRI-ALL PURP.ANCHORS 8X51	200
8112 10	TRI-ALL PURP.ANCHORS 10X61	100
8112 12	TRI-ALL PURP.ANCHORS 12X71	50
9004 1 10 10	INS.BOX BLUE10X10CM VAROBOXX 1	1
9004 1 10 15	INSETB.L-GR.10X15CM VAROBOXX 1	1
9008 1	VAROIBOXX EMPTY	1
9008 75 260	VAROIBOXX INSET.B.GREY7.5X26MM	3

Article No.	Article Description	QTY
9007 8112	TRI ALL-PURP.ANCH.VARIOBOXX	1



TRIKA All-Purpose Anchors **VAROiBOXX**

- Assortment in VAROiBOXX
- Set contains 650x TRIKA all-purpose anchors in 4 different sizes

Contents

Article No.	Article Description	Quantity
8113 6	TRIKA-ALL PURPOSE PLUGS 6X36	300
8113 8	TRIKA-ALL PURPOSE PLUGS 8X51	200
8113 10	TRIKA-ALL PURPOSE PLUGS 10X61	100
8113 12	TRIKA-ALL PURPOSE PLUGS 12X71	50
9004 1 10 10	INS.BOX BLUE10X10CM VAROBOXX 1	1
9004 1 10 15	INSETB.L-GR.10X15CM VAROBOXX 1	1
9008 1	VAROIBOXX EMPTY	1
9008 75 260	VAROIBOXX INSET.B.GREY7.5X26MM	3

Article No.	Article Description	QTY
9007 8113	VARIOBOXX TRIKA ALL-PURP.ANCH	1



First Aid **VAROiBOXX**

- Ideal in conjunction with the wall bracket for VAROiBOXX (Art. No. 9008 7)
- Art. No. 9007 13157:**
- In accordance with DIN 13157
- Art. No. 9007 13169:**
- In accordance with DIN 13169

Article No.	Article Description	QTY
9007 13157	VAROiBOXX FIRST AID DIN13157	1
9007 13169	VAROiBOXX FIRST AID DIN13169	1



Type of operation	First aid box quantities according to:					
	DIN 13157 (small first aid box)		DIN 13169 (large first aid box)			
Building sites	1 – 10 insured pers.	1	11 to 50 insured	1	for 50 additional insured	1
Manufacturing and processing companies	1 – 20 insured pers.	1	21 to 100 insured pers.	1	for 100 additional insured pers.	1
Administrative and trading companies	1 – 50 insured pers.	1	51 to 300 insured pers.	1	from 301 insured pers.	2
Other companies		1	–		–	

VAROBOXX Mini, Empty

- Organization, partition, and transport system for small parts
- Stackable and can be clicked together
- Seven flexibly removable partitions
- With practical carrying handle
- Max. loading single box 1.5 kg, combined max. 5 kg
- Food safe and dishwasher safe
- Internal dimensions (W x D x H): 235 x 140 x 43 mm
- External dimensions (W x D x H): 260 x 155 x 63 mm



Article No.	Article Description	QTY
9002 1	VAROBOXX MINI EMPTY	1

Pre-cut Foam Inserts VAROBOXX Mini

- Pre-perforated foam insert
- Individual adaptation of the insert
- For the protection of delicate components
- Compatible with VAROBOXX Mini



Article No.	Article Description	QTY
9002 2	PRE-CUT FOAM INS.VAROBOXX MINI	1

Chipboard Screws SK PZ /Dowels VAROBOXX Mini

- 600 pieces
- Assortment in premium VAROBOXX Mini
- Universal mounting range

Contents

Article No.	Article Description	Quantity
1601 35 50	CSK PZ2 CHIPBSCR. ZP 3.5X 50	100
1601 4 50	CSK PZ2 CHIPBSCR. GA 4X 50	100
1601 6 70	CSK PZ3 CHIPBSCR. GA 6X 70	50
8108 5	UNIVERSAL PLUG GX PREMIUM 5MM	200
8108 6	UNIVERSAL PLUG GX PREMIUM 6MM	100
8108 8	UNIVERSAL PLUG GX PREMIUM 8MM	50
9002 1	VAROBOXX MINI EMPTY	1



Article No.	Article Description	QTY
9002 1601 8108	VAROBOXX MINI SK-PZ-SPS/ANCHOR	1

Screw Hooks **VAROBOXX** Mini

- 120 parts
- Assortment in high-grade VAROBOXX Mini
- universal assortment with common hooks

Contents

Article No.	Article Description	Quantity
1854 34 50	FIX.HOOK STRAI.WT ZI 3.4X 50	25
1856 28 40	SCREW HOOK BENT WT GA 2.8X 40	50
1856 34 50	SCREW HOOK BENT WT GA 3.4X 50	25
1858 34 50	CEIL. HOOK CURV.WT GA 3.4X 50	25
1859 52 80	CHANDELIER HOOK WT GA 5.2X 80	10
1865 58 65	FIX.HOOK STRA.SLOTTED 5.8X65	10
9002 1	VAROBOXX MINI EMPTY	1



Article No.	Article Description	QTY
9002 18	VAROBOXX MINI SCREW HOOKS	1

Lynch Pins / Hitch Pins **VAROBOXX** Mini

- 100 parts
- in high-grade VAROBOXX Mini
- Assortment for vehicle, engineering or agriculture

Contents

Article No.	Article Description	Quantity
2810 45	LYNCH PIN YC 4.5	15
2810 6	LYNCH PIN YC 6	10
2810 8	LYNCH PIN YC 8	5
2811 2	R PIN SINGLE EYE ZINC M2	25
2811 3	R PIN SINGLE EYE ZINC M3	25
2811 4	R PIN SINGLE EYE ZINC M4	20
9002 1	VAROBOXX MINI EMPTY	1



Article No.	Article Description	QTY
9002 2810 2811	VAROBOXX MINI LYNCH/HITCH PINS	1

Electrical Tape 12 mm **VAROBOXX** Mini

- 24 pieces
- Assortment in premium VAROBOXX Mini
- Certified to VDE 0340 DIN EN 60454
- Soft PVC film, 0.15 mm thick
- Dielectric strength 6.5 KV, resistant to combustion
- Ageing and temperature resistant
- Resistant to dilute acids and alkalis

Contents

Article No.	Article Description	Quantity
3740 1	RO(10M)ISOT.0.15X12MM VDE BLAC	5
3740 2	RO(10M)ISOT.0.15X12MM VDE RED	5
3740 3	RO(10M)VDE INS-TAPE 12MM GREEN	3
3740 4	RO(10M)ISOT.0.15X12MM VDE BLUE	3
3740 5	RO(10M)ISOT.0.15X12MM VDE YELL	3
3740 6	RO(10M)VDE INS-TAPE 12MM WHITE	5
9002 1	VAROBOXX MINI EMPTY	1



Article No.	Article Description	QTY
9002 3740	VAROMOBIL MINI ELECTR.TAPE	1

Batteries **VAROBOXX** Mini

- 36 parts
- Assortment in high-grad VAROBOXX Mini
- Universal assortment with common batteries

Contents

Article No.	Article Description	Quantity
3880 15 1	BATTERY ALKALINE MIGNON 1,5V	16
3880 15 2	BATTERY ALKALINE BABY 1,5V	6
3880 15 3	BATTERY ALKALINE MICRO 1,5V	10
3880 9	BATTERY ALKALINE E-BLOCK 9V	4
9002 1	VAROBOXX MINI EMPTY	1

Article No.	Article Description	QTY
9002 3880	VAROBOXX MINI BATTERIES	1



1/4" Bits PZ / PH **VAROBOXX** Mini **FÖRCH** *****

- Contents: 140 bits
- Assortment in high-grade VAROBOXX Mini
- Bits in professional quality with colour coding system
- Bits in viscous design for hard screw joints

Contents

Article No.	Article Description	Quantity
4311 5 1	1/4"PH-BIT 25MM SZ.1 YELLOW 5*	20
4311 5 2	1/4"PH-BIT 25MM SZ.2 WHITE 5*	30
4311 5 3	1/4"PH-BIT 25MM SZ.3 RED 5*	20
4312 5 1	1/4"PZ-BIT 25MM SZ.1 BLUE 5*	20
4312 5 2	1/4"PZ-BIT 25MM SZ.2 BLACK 5*	30
4312 5 3	1/4"PZ-BIT 25MM SZ.3 GREEN 5*	20
9002 1	VAROBOXX MINI EMPTY	1

Article No.	Article Description	QTY
9002 4311 4312	VAROBOXX MINI 1/4"BITS PZ/PH5*	1



1/4" Bits TX **VAROBOXX** Mini **FÖRCH** *****

- Contents: 140 bits
- Assortment in high-grade VAROBOXX Mini
- Bits in professional quality with colour code system
- Bits in viscous design for hard screw joints

Contents

Article No.	Article Description	Quantity
4314 5 10	1/4"BIT 25MM TX10 BLUE 5*	20
4314 5 15	1/4"BIT 25MM TX15 YELLOW 5*	20
4314 5 20	1/4"BIT 25MM TX20 WHITE 5*	30
4314 5 25	1/4"BIT 25MM TX25 BLACK 5*	30
4314 5 30	1/4"BIT 25MM TX30 RED 5*	20
4314 5 40	1/4"BIT 25MM TX40 GREY 5*	20
9002 1	VAROBOXX MINI EMPTY	1

Article No.	Article Description	QTY
9002 4314	VAROBOXX MINI 1/4" BITS TX 5*	1



Marker **VAROBOXX** Mini

- 17 parts
- in high-grade VAROBOXX Mini
- universal marker set for different materials

Contents

Article No.	Article Description	Quantity
4713 10 2	PERM.MARKER RETRACT11 RED1.5-3	2
4713 10 3	PER.MARKER RETRACT11 BLUE1.5-3	1
4713 10 4	PER.MARKER RETRACT11GREEN1.5-3	1
4713 10 5	PER.MARKER RETRACT11BLACK1.5-3	2
4713 11 2	PERMANENT MARKER RED 1MM	2
4713 11 3	PERMANENT MARKER BLUE 1MM	1
4713 11 4	PERMANENT MARKER GREEN 1MM	1
4713 11 5	PERMANENT MARKER BLACK 1MM	2
4713 12 1	INDUSTRY PAINT MARKER YEL2-4MM	1
4713 12 2	INDUSTRY PAINT MARKER RED2-4MM	1
4713 12 5	INDUSTRY PAINT MARK.BLACK2-4MM	1
4713 12 6	INDUSTRY PAINT MARK.WHITE2-4MM	2
9002 1	VAROBOXX MINI EMPTY	1



Article No.	Article Description	QTY
9002 4713	VAROBOXX MINI MARKER	1

Cutting Knife 9 mm **VAROBOXX** Mini **ECO**

- 33 parts
- Assortment in high-grade VAROBOXX Mini
- Knives and blades in practical assortment

Contents

Article No.	Article Description	Quantity
4762 9	CUTTING KNIFE 9MM	30
4762 50 10	PK(10)RETR.BLADE PROFI 9MM	3
9002 1	VAROBOXX MINI EMPTY	1



Article No.	Article Description	QTY
9002 4762 9	VAROBOXX MINI CUTT.KNIFE 9MM	1

Cutting Knife 18 mm **VAROBOXX** Mini

- 11 parts
- Assortment in high-grade VAROBOXX Mini
- Knives and blades in practical assortment

Contents

Article No.	Article Description	Quantity
4762 18 3	CUTTERKNIFE 18MM	6
4762 40 10	PK(10)RET.BLADE TYPE1 PROF.18MM	5
9002 1	VAROBOXX MINI EMPTY	1



Article No.	Article Description	QTY
9002 4762 18	VAROBOXX MINI CUTT.KNIFE 18MM	1

PSA Assortment Standard **VAROBOXX** Mini

- 4 parts
- in high-grade VAROBOXX Mini
- ideal protective equipment for employees

Contents

Article No.	Article Description	Quantity
5400 908 1	"THETA" CLEAR SAFETY GLAS.	1
5402 3 10	P(10PAIRS)EAR PLUGS SZ.S	1
5403 2 2	FINE DUST FOLD.MASK FFP2 W.VEN	1
5405 117 10	FINE KNIT.GL.DUO-GRIP SZ 10	1
9002 1	VAROBOXX MINI EMPTY	1

Article No.	Article Description	QTY
9002 54	VAROBOX MINI PSA STANDARD	1



PSA Assortment Premium **VAROBOXX** Mini

- 4 parts
- in high-grade VAROBOXX Mini
- ideal protective equipment for employees

Contents

Article No.	Article Description	Quantity
5400 904 1	"DELTA CLEAR" SAFETY GLAS.	1
5402 12	BILSOM EARPLUG 556	1
5403 2 2	FINE DUST FOLD.MASK FFP2 W.VEN	1
5405 5 305 10	MAXIFLEX ULTIM.PART.COAT.10 5*	1
9002 1	VAROBOXX MINI EMPTY	1

Article No.	Article Description	QTY
9002 54 1	VAROBOX MINI PSA PREMIUM	1



Jigsaw Blades **VAROBOXX** Mini

- 75 parts
- Assortment in high-grade VAROBOXX Mini
- Jigsaw-assortment for wood, metal and plastic

Contents

Article No.	Article Description	Quantity
5721P 12 26 75	HP(25)KEYH.BL.B-H PROGR.METAL	1
5721P 20 30 90	HP(25)KEYH.BL.B-H PROGR.WOOD	1
5721P 25 18 75	HP(25)KEY.SAW B.B-M25/18/75VBI	1
9002 1	VAROBOXX MINI EMPTY	1

Article No.	Article Description	QTY
9002 5721	VAROBOX MINI JIGSAW BLADES	1



Universal Plugs GX Premium **VAROBOXX** Mini

- 350 parts
- in high-grade VAROBOXX Mini
- universal plug assortment

Contents

Article No.	Article Description	Quantity
8108 5	UNIVERSAL PLUG GX PREMIUM 5MM	100
8108 6	UNIVERSAL PLUG GX PREMIUM 6MM	100
8108 8	UNIVERSAL PLUG GX PREMIUM 8MM	100
8108 10	UNIVERSAL PLUG GX PREMIUM 10MM	50
9002 1	VAROBOXX MINI EMPTY	1



Article No.	Article Description	QTY
9002 8108	VAROBOXX MINI UNI-ANCHOR GX	1

Tri All-purpose Anchors **VAROBOXX** Mini

- 300 parts
- in high-grade VAROBOXX Mini
- universal anchor assortment

Contents

Article No.	Article Description	Quantity
8112 5	TRI ALL-PURP.ANCHOR 5X31	100
8112 6	TRI ALL PUP.ANCHORS 6X36	100
8112 8	TRI-ALL PURP.ANCHORS 8X51	50
8112 10	TRI-ALL PURP.ANCHORS 10X61	50
9002 1	VAROBOXX MINI EMPTY	1



Article No.	Article Description	QTY
9002 8112	VAROBOXX MINI TRI ALL-PUP.ANCH	1

Trika All-purpose Anchors **VAROBOXX** Mini

- 300 parts
- in high-grade VAROBOXX Mini
- universal anchor assortment

Contents

Article No.	Article Description	Quantity
8113 5	TRIKA-ALL PURPOSE PLUGS 5X31	100
8113 6	TRIKA-ALL PURPOSE PLUGS 6X36	100
8113 8	TRIKA-ALL PURPOSE PLUGS 8X51	50
8113 10	TRIKA-ALL PURPOSE PLUGS 10X61	50
9002 1	VAROBOXX MINI EMPTY	1



Article No.	Article Description	QTY
9002 8113	VAROBOXX MINI TRIKA ALL-P.ANCH	1

Connection Terminals **VAROBOXX** Mini

- 270 pieces
- Assortment in premium VAROBOXX Mini
- For the quick and easy connection of cables

Contents

Article No.	Article Description	Quantity
8450 4 2	CONNECT.TERM.RELEASE.2-POLE	25
8450 4 3	CONNECT.TERM.RELEASE.3-POLE	25
8450 4 5	CONNECT.TERM.RELEASE.5-POLE	20
8450 7 2	CONN.CLAMP 0,5-2,5MM ² 2POL.	100
8450 7 3	CONN.CLAMP 0,5-2,5MM ² 3POL.	50
8450 7 5	CONN.CLAMP 0,5-2,5MM ² 5POL.	50
9002 1	VAROBOXX MINI EMPTY	1



Article No.	Article Description	QTY
9002 8450	VAROBOXX MINI CONNECT.TERMINAL	1

Connection Terminals **VAROBOXX** Mini

- 325 pieces
- Assortment in premium VAROBOXX Mini
- for the quick and easy connection of cables

Contents

Article No.	Article Description	Quantity
8450 7 2	CONN.CLAMP 0,5-2,5MM ² 2POL.	100
8450 7 3	CONN.CLAMP 0,5-2,5MM ² 3POL.	50
8450 7 5	CONN.CLAMP 0,5-2,5MM ² 5POL.	50
8450 8 2	MINI CONN.TERMINAL 2-POLE	50
8450 8 3	MINI CONN.TERMINAL 3-POLE	50
8450 8 5	MINI CONN.TERMINAL 5-POLE	25
9002 1	VAROBOXX MINI EMPTY	1



Article No.	Article Description	QTY
9002 8450 2	VAROBOXX MINI CONN.TERM.MINI	1

FORCH VAROMOBIL is vital mobility for the trade

MOBIL storage and retrieval of all products which are required in the vehicle is designed for all types of manufactures and for DIY installation

It consists of the **VAROMOBIL-vehicle device**, a heavy-duty shelving system made of innovative composite and lightweight honeycomb material and the system-compatible **VAROBOXX**, which we also offer as an assortment with industry and product-specific consumables and tools.

Accordingly, it can be customised to your requirements and needs

Your Benefits

Economical

- For self-assembly and therefore low total cost
- Simple DIY-installation in the vehicle
- Short search times thanks to clear organisation

Compatibility

- For varied requirements
- For all popular vehicle models

Innovative

- specially developed for construction sites and field work vehicles by tradespeople
- very low weight



Assembling the vehicle device



Installation of vehicle device



Crashtest

Safely on the road in just a few steps with FORCH VAROMOBIL

1. Advice

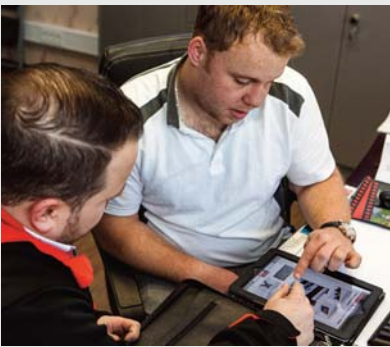

2. Order



3. Delivery



4. Setup



5. Installation



6. In use



System overview

VAROMOBIL Vehicle installation

Shelving system for DIY installation in the vehicle and system compatible with all VAROBOXXes. The shelves can be mounted individually for a configuration with VAROBOXX. Shelves, shelf tray and drawers also allow customised storage of equipment..



VAROBOXX
Available in four different sizes and in more than 80 industry-specific assortments.

VAROBOXX LT
Quick access to all objects, ideal for bulky items. Compatible with all VAROBOXXes.

VAROiBOXX RACK
Space for three/five VAROBOXX or three/five VAROBOXX LS drawers. Stackable and clickable, for individual assembly

VAROBOXX Mini
Organisation, separation and transportation system for small parts: click and stack the them with each other, with seven flexible and detachable separation plates and practical handle.

VAROiBOXX
Transparent lid for quick identification of contents. Using VAROBOXX RACK, can be clicked into all VAROBOXXes. More than 80 industry-specific assortments

Modular components

Shelf tray:

The shelf tray is extremely versatile. In the example here, the tray is used to transport long objects inside the vehicle.

Drawers:

The drawers are available in a range of widths and heights for different modules. Beneficial features of the drawers include user-friendly plastic handles and stability when the drawers are fully extended. The drawers can be loaded with up to 30 kg of equipment.

Slide-in module for VAROBOXXes:

The modules also offer space for VAROBOXXES in different sizes. VAROBOXXES are ideal for storing sundries, spare parts and screws.

Side walls:

The impressively lightweight heavy-duty side walls are made from an innovative composite material that is extremely resistant to oils, acids and cleaning agents.

Insertion for VAROBOXXes:

The modules also feature space for VAROBOXXES in different sizes. These offer numerous possibilities for arrangement and thus can be used according to your individual ideas and preferences.

Shelves and trays:

Shelves and trays can be fitted to fully utilize the space available inside the vehicle: Everything from tools to spare parts can be stored tidily on the shelves and trays in the modules. The trays can be subdivided using additional separating walls.

Base flap:

The base flaps provide visual protection and safety in your vehicle while keeping your equipment tidy.



Vehicle protection

Wall panel (SV):

- protects the inside of the vehicle against damages
- extremely impact and scratch resistant
- moisture and chemical resistant
- precisely tailored to the vehicle type
- adequate page panel package for each vehicle type
- 100% recyclable honeycomb material
- 60% lighter than wood



Protective flooring:

- Of waterproof glued Nordic birchwood
- Protects the vehicle floor against damage
- Extremely scratch and impact proof
- For secure mounting of the equipment modules
- No drilling of the vehicle floor necessary
- Pre-drilled holes enable simple assembly on the original anchor points of the vehicle
- Pre-cut to size and precisely tailored to the vehicle
- Thickness: 9 mm
- **Vehicle floor can only be used for vehicles:**
- with original steel partition walls (no grille) for separation of the driver's cab
- with a sliding door on the passenger side

Note:

- a protective floor is absolutely essential if no other suitable floor is present (original floor or other type of floor with a min. thickness of 9mm resp. glued multiplex sheets)
- as these floors are custom-made replacement of floors and page page cladding is not possible

Mounting parts included in delivery scope.

Accessories

VAROMOBIL hook rack:

This product was specially designed for the block side walls on all VAROMOBIL modules. Suitable for hanging jackets, cables, hoses, etc.



VAROMOBIL storage compartment:

The storage compartment is compatible with all VAROMOBIL modules. Suitable for mounting on the system wall on the side of the vehicle rack.



VAROMOBIL Accessories:

The VAROMOBIL hook rack and VAROiBOXX wall bracket are just two examples from the extensive VAROMOBIL accessories range. The range offers a host of practical benefits for a wide variety of industries.

VAROiBOXX:

Secure any VAROiBOXX easily to the vehicle rack within easy reach using this wall bracket.



Guideline

In 7 steps to your individual VAROMOBIL-vehicle interior.

Step 1:

Creating the vehicle type and vehicle details with the enclosed form:



Step 2:

Selection of the suitable modular package:
Overview list for vehicle types and modular packages:

Citroen							
Modell	ab Modelljahr	Radstand	Überlänge	Antriebsart	Höhe	Modulpaket	Seite
Nemo	2008	2.513 mm	-	Front	Normal	A	14
Berlingo	2008	2.728 mm	-	Front	Normal	C	16
Berlingo	2008	2.728 mm	L2	Front	Normal	C	16
Jumpy	2007	3.000 mm	-	Front	Normal	D	17
Jumpy	2007	3.122 mm	-	Front	Normal	E	18/19
Jumper	2006	3.000 mm	-	Front	Normal	G	21
Jumper	2006	3.000 mm	-	Front	Mittel	G	21
Jumper	2006	3.450 mm	-	Front	Normal	H	22
Jumper	2006	3.450 mm	-	Front	Mittel	H	22
Jumper	2006	4.035 mm	-	Front	Mittel	J	24
Fiat							
Modell	ab Modelljahr	Radstand	Überlänge	Antriebsart	Höhe	Modulpaket	Seite
Fiorino	2008	2.513 mm	-	Front	Normal	A	14
Doblo	2010	2.755 mm	-	Front	Normal	A	14
Doblo	2010	3.105 mm	-	Front	Normal	B	15
Scudo	2007	3.000 mm	-	Front	Normal	D	17
Scudo	2007	3.122 mm	-	Front	Normal	E	18/19

Step 3:

Selections of basic and premium module and possible completion with further accessories:



Step 4:

Selection of suitable floor:



Step 5:

Selection of suitable side panel cover:

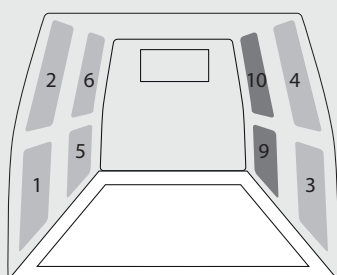

Step 6:

Individual equipment with accessories:



Step 7:

Selection of equipped VAROBOXXes and VAROiBOXXes from more than 170 trade-specific programmes:



Modular Packages

Select between basic module or premium module.

A Basic modular block

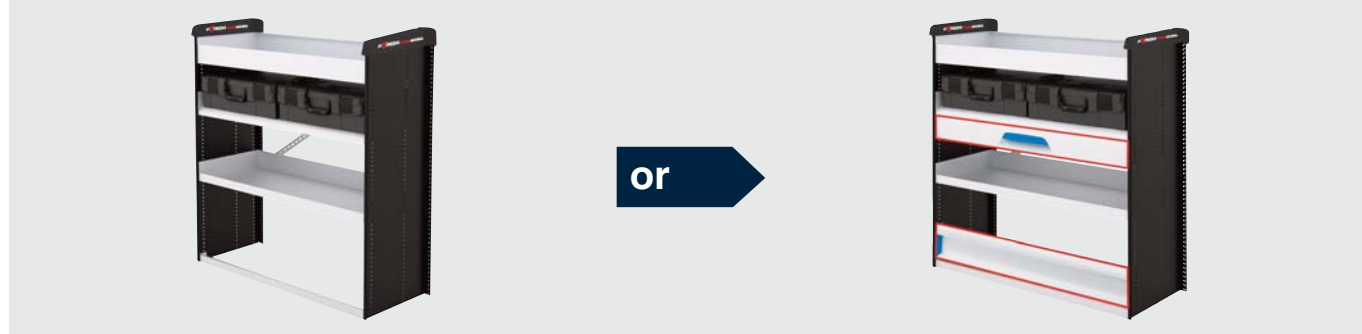

Basic module:

- 1x lower shelf tank bottom (max. load 80 kg)
- 1x lower shelf with frame (max. load 50 kg)
- 1x lower shelf (max. load 80 kg) incl. pull-out rails for 2 VAROBOXXes
- max. load per module: 100 kg

Premium module:

additional

- 1x drawer (max. load 30 kg)
- 1x shelf flap
- max. load per module: 100 kg

The respective basic modular block may be extended depending on the vehicle type by a suitable extension module.

B Extension module

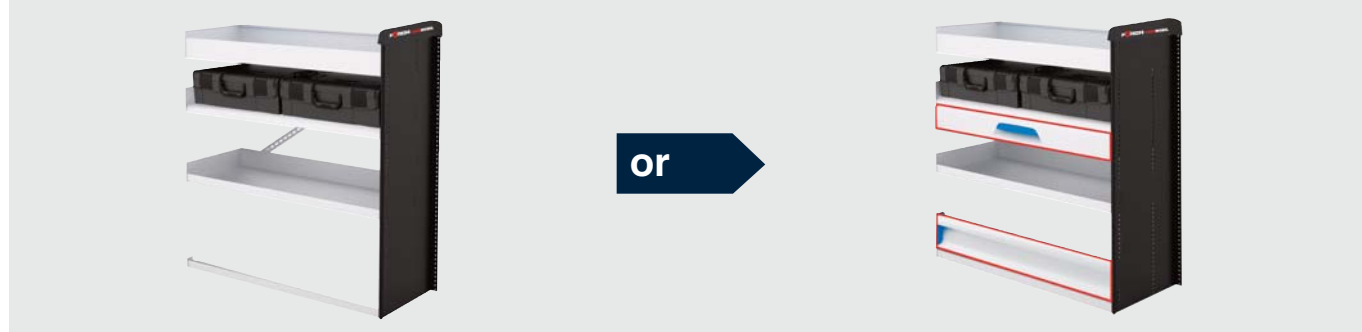

The combination of basic modular block and extension block as modular package is the ideal vehicle interior equipment to optimally exploit the existing space.

C Modular package



Overview

Model	From model	Wheelbase	Excess length	Drive type	Height	Modular pack	Page
Citroen							
Nemo	2008	2.513 mm	–	Front	Normal	A	18/870
Berlingo	2008	2.728 mm	–	Front	Normal	C	18/874
Berlingo	2008	2.728 mm	L2	Front	Normal	C	18/874
Jumpy	2007	3.000 mm	–	Front	Normal	D	18/875
Jumpy	2007	3.122 mm	–	Front	Normal	E	18/876, 877
Jumpy	2016	2.925 mm	–	Front	Normal	D	18/875
Jumpy	2016	3.275 mm	–	Front	Normal	E	18/876, 877
Jumpy	2016	3.275 mm	L3	Front	Normal	E	18/876, 877
Jumper	2006	3.000 mm	–	Front	Normal	G	18/882
Jumper	2006	3.000 mm	–	Front	Medium	G	18/882
Jumper	2006	3.450 mm	–	Front	Normal	H	18/885
Jumper	2006	3.450 mm	–	Front	Medium	H	18/885
Jumper	2006	4.035 mm	–	Front	Medium	J	18/887
Dacia							
Dokker	2012	2.810 mm	–	Front	Normal	A	18/870
Fiat							
Fiorino	2008	2.513 mm	–	Front	Normal	A	18/870
Doblo	2010	2.755 mm	–	Front	Normal	A	18/870
Doblo	2010	3.105 mm	–	Front	Normal	B	18/871
Scudo	2007	3.000 mm	–	Front	Normal	D	18/875
Scudo	2007	3.122 mm	–	Front	Normal	E	18/876, 877
Ducato	2006	3.000 mm	–	Front	Normal	G	18/882
Ducato	2006	3.000 mm	–	Front	Medium	G	18/882
Ducato	2006	3.450 mm	–	Front	Normal	H	18/885
Ducato	2006	3.450 mm	–	Front	Medium	H	18/885
Ducato	2006	4.035 mm	–	Front	Medium	J	18/887
Talento	2016	3.098 mm	–	Front	Normal	E	18/876, 877
Talento	2016	3.498 mm	–	Front	Normal	E	18/876, 877
Ford							
Courier	2014	2.489 mm	–	Front	Normal	A	18/870
Connect	2014	2.662 mm	–	Front	Normal	A	18/870
Connect	2014	3.062 mm	–	Front	Normal	B	18/871
Custom	2012	2.933 mm	–	Front	Normal	E	18/876, 877
Custom	2012	3.300 mm	–	Front	Normal	E	18/876, 877
Transit	2014	3.300 mm	–	Front	Medium	I	18/886
Transit	2014	3.300 mm	–	Rear	Medium	I	18/886
Transit	2014	3.750 mm	–	Front	Medium	J	18/887
Transit	2014	3.750 mm	–	Rear	Medium	J	18/887
Iveco							
Daily	2014	3.000 mm	–	Front	Normal	G	18/882
Daily	2014	3.520 mm	–	Front	Normal	I	18/886
Daily	2014	3.520 mm	L	Front	Normal	J	18/887
Daily	2014	4.100 mm	–	Front	Normal	J	18/887
Daily	2014	4.100 mm	L	Front	Normal	J	18/887
MAN							
TGE	2016	3.640 mm	–	Front	Normal	I	18/886
TGE	2016	3.640 mm	–	Front	Medium	I	18/886
TGE	2016	3.640 mm	–	Rear	Normal	I	18/886
TGE	2016	4.490 mm	–	Rear	Medium	J	18/887

(Continued on next page)

Overview

Model	From model	Wheelbase	Excess length	Drive type	Height	Modular pack	Page
Mercedes-Benz							
Citan	2012	2.697 mm	–	Front	Normal	A	18/870
Citan	2012	3.081 mm	–	Front	Normal	B	18/871
Vito	2010/2014	3.200 mm	L1	Front	Normal	E	18/876, 877
Vito	2010/2014	3.200 mm	L2	Front	Normal	E	18/876, 877
Vito	2010/2014	3.430 mm	–	Front	Normal	E	18/876, 877
Sprinter	2006	3.250 mm	–	Front	Normal	G	18/882
Sprinter	2006	3.250 mm	–	Front	Medium	G	18/882
Sprinter	2006	3.665 mm	–	Front	Normal	J	18/887
Sprinter	2006	3.665 mm	–	Front	Medium	J	18/887
Sprinter	2006	4.325 mm	–	Front	Medium	J	18/887
Nissan							
NV200	2010	2.725 mm	–	Front	Normal	D	18/875
Primastar	2001	3.098 mm	–	Front	Normal	E	18/876, 877
Primastar	2001	3.498 mm	–	Front	Normal	E	18/876, 877
NV300	2016	3.098 mm	–	Front	High	E	18/887
NV300	2016	3.098 mm	–	Front	Normal	E	18/887
NV300	2016	3.498 mm	–	Front	High	E	18/887
NV300	2016	3.498 mm	–	Front	Normal	E	18/876, 877
NV400	2012	3.182 mm	–	Front	Normal	G	18/882
NV400	2012	3.182 mm	–	Front	Medium	G	18/882
NV400	2012	3.682 mm	–	Front	Medium	H	18/885
NV400	2012	3.682 mm	–	Rear	Medium	H	18/885
NV400	2012	4.332 mm	–	Front	Medium	J	18/887
Opel							
Combo	2012	2.755 mm	–	Front	Normal	A	18/870
Combo	2012	3.105 mm	–	Front	Normal	B	18/871
Vivaro	2001/2014	3.098 mm	–	Front	Normal	E	18/876, 877
Vivaro	2001/2014	3.498 mm	–	Front	Normal	E	18/876, 877
Movano	2010	3.182 mm	–	Front	Normal	G	18/882
Movano	2010	3.182 mm	–	Front	Medium	G	18/882
Movano	2010	3.682 mm	–	Front	Medium	H	18/885
Movano	2010	3.682 mm	–	Rear	Medium	H	18/885
Movano	2010	4.332 mm	–	Front	Medium	J	18/887
Peugeot							
Bipper	2008	2.513 mm	–	Front	Normal	A	18/870
Partner	2008	2.728 mm	–	Front	Normal	C	18/874
Partner	2008	2.728 mm	L2	Front	Normal	C	18/874
Expert	2007	3.000 mm	–	Front	Normal	D	18/875
Expert	2007	3.122 mm	–	Front	Normal	E	18/876, 877
Expert	2016	2.925 mm	–	Front	Normal	D	18/875
Expert	2016	3.275 mm	–	Front	Normal	E	18/876, 877
Expert	2016	3.275 mm	L3	Front	Normal	E	18/876, 877
Boxer	2006	3.000 mm	–	Front	Medium	G	18/882
Boxer	2006	3.000 mm	–	Front	Normal	G	18/882
Boxer	2006	3.450 mm	–	Front	Medium	H	18/885
Boxer	2006	3.450 mm	–	Front	Normal	H	18/885
Boxer	2006	4.035 mm	–	Front	Medium	J	18/887

(Continued on next page)

Overview

Model	From model	Wheelbase	Excess length	Drive type	Height	Modular pack	Page
Renault							
Kangoo	2008	2.697 mm	–	Front	Normal	A	18/870
Kangoo	2008	3.081 mm	–	Front	Normal	B	18/871
Trafic	2001/2014	3.098 mm	–	Front	Normal	E	18/876, 877
Trafic	2001/2014	3.498 mm	–	Front	Normal	E	18/876, 877
Master	2010	3.182 mm	–	Front	Normal	G	18/882
Master	2010	3.182 mm	–	Front	Medium	G	18/882
Master	2010	3.682 mm	–	Front	Medium	H	18/885
Master	2010	3.682 mm	–	Rear	Medium	H	18/885
Master	2010	4.332 mm	–	Front	Medium	J	18/887
Toyota							
Proace	–	3.000 mm	–	Front	Normal	D	18/875
Proace	–	3.122 mm	–	Front	Normal	E	18/876, 877
Proace	2016	2.925 mm	–	Front	Normal	D	18/875
Proace	2016	3.275 mm	–	Front	Normal	E	18/876, 877
Proace	2016	3.275 mm	L3	Front	Normal	E	18/876, 877
VW							
Caddy	2003	2.682 mm	–	Front	Normal	A	18/870
Caddy Maxi	2008	3.002 mm	–	Front	Normal	B	18/871
T5/T6	2003	3.000 mm	–	Front	Medium	F	18/880
T5/T6	2003	3.000 mm	–	Front	Normal	F	18/880
T5/T6	2003	3.400 mm	–	Front	Medium	F	18/880
T5/T6	2003	3.400 mm	–	Front	Normal	F	18/880
Crafter	2006	3.250 mm	–	Front	Normal	G	18/882
Crafter	2006	3.250 mm	–	Front	Medium	G	18/882
Crafter	2006	3.665 mm	–	Front	Medium	J	18/887
Crafter	2006	3.665 mm	–	Front	Normal	J	18/887
Crafter	2006	4.325 mm	–	Front	Medium	J	18/887
Crafter	2016	3.640 mm	–	Front	Normal	I	18/886
Crafter	2016	3.640 mm	–	Front	Medium	I	18/886
Crafter	2016	3.640 mm	–	Rear	Normal	I	18/886
Crafter	2016	4.490 mm	–	Rear	Medium	J	18/887

Modular package A:

Installation Driver's side:



Module 44 – 50

Width: 1.004 mm

Height: 876 mm

Depth: 370 mm

(PT = partial thread)

Installation Passenger's side:



Module 34 – 50

Width: 762 mm

(PT = partial thread)

	Basis block	Weight
Basic module:	Art. No. 9009 44 50	approx 18 kg
Premium module:	Art. No. 9009 44 50 1	approx 25 kg

	Basis block	Weight
Basic module:	Art. No. 9009 34 50	approx 16 kg
Premium module:	Art. No. 9009 34 50 1	approx .21 kg

 (PT = partial thread)

Select your individual modular equipment:

Basic module or premium module (incl. drawer and shelf flap)

You can add further drawers and shelf flaps in different heights, as well as more shelves and shelf tank bottoms to your vehicle equipment (see accessories from Page 18/890).

Floors and side panels:

For standard vans (without a window, bench, separating grid, etc. in the cargo space)

Model	from Model	Wheelbase	Excess length	Drive type	Height	Art. No. of floor	Art. No. of side panel	Image No.
Ford Courier with partition With separating grid	2014	2.489 mm	–	Front	Normal	9011 1000003219 9011 1000003391	9011 1000003220 9011 1000003220	2, 4, 5, 6 2, 4, 5, 6
Citroen Nemo	2008	2.513 mm	–	Front	Normal	9011 331012740	9011 331012741	2, 4, 6
Dacia Dokker	2012	2.810 mm	–	Front	Normal	9011 1000001554	–	–
Fiat Doblo	2010	2.755 mm	–	Front	Normal	9011 331016509	9011 331016984	2, 4, 6
Fiat Fiorino	2008	2.513 mm	–	Front	Normal	9011 331012740	9011 331012741	2, 4, 6
Ford Connect ¹⁾	2014	2.662 mm	–	Front	Normal	9011 1000002597	9011 1000002604	1 – 6
Mercedes-Benz Citan	2012	2.697 mm	–	Front	Normal	9011 331013206	9011 331013210	2, 4, 6
Opel Combo	2012	2.755 mm	–	Front	Normal	9011 331016509	9011 331016984	2, 4, 6
Peugeot Bipper	2008	2.513 mm	–	Front	Normal	9011 331012740	9011 331012741	2, 4, 6
Renault Kangoo	2008	2.697 mm	–	Front	Normal	9011 331013206	9011 331013210	2, 4, 6
VW Caddy ²⁾	2003	2.682 mm	–	Front	Normal	9011 331001450	9011 331001437	1 – 6

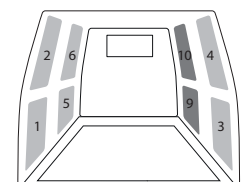

Modular package B:

Installation Driver's side:

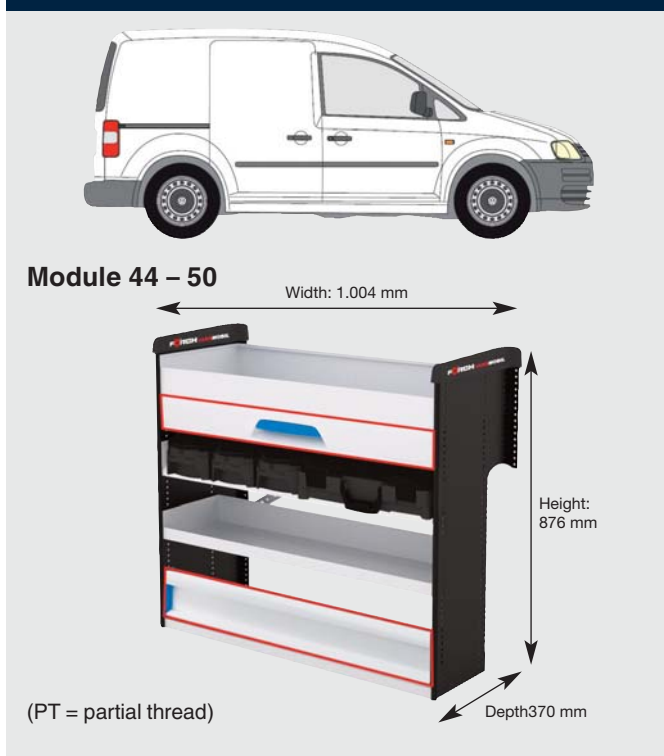

Installation Passenger's side:



	Basis block	Weight
Basic module:	Art. No. 9009 44 50	approx 18 kg
Premium module:	Art. No. 9009 44 50 1	approx 25 kg

	Basis block	Weight
Basic module:	Art. No. 9009 44 50	approx 18 kg
Premium module:	Art. No. 9009 44 50 1	approx . 25 kg

(PT = partial thread)

Select your individual module equipment:

Basic module or premium module (incl. drawer and shelf flap)

You can add further drawers and shelf flaps in different heights, as well as more shelves and shelf tank bottoms to your vehicle equipment (see accessories from Page 18/890).

Floors and side panels:

For standard vans (without a window, bench, separating grid, etc. in the cargo space)

Model	from Model	Wheelbase	Excess length	Drive type	Height	Art. No. of floor	Art. No. of side panel	Image No.
Fiat Doblo	2010	3.105 mm	-	Front	Normal	9011 331016510	9011 331016985	2, 4, 6
Ford Connect ¹⁾	2014	3.062 mm	-	Front	Normal	9011 1000002535	9011 1000002638	1 - 6
Mercedes-Benz Citan	2012	3.081 mm	-	Front	Normal	9011 331017394	9011 331017383	2, 4, 6
Opel Combo	2012	3.105 mm	-	Front	Normal	9011 331016510	9011 331016985	2, 4, 6
Renault Kangoo	2008	3.081 mm	-	Front	Normal	9011 331017394	9011 331017383	2, 4, 6
VW Caddy Maxi ²⁾	2008	3.002 mm	-	Front	Normal	9011 331012928	9011 331012932	1 - 6

Additional accessories:

Such as trays, hose holders or non-slip mats can be found from 18/928. All VAROMOBIL-accessories are compatible also with VAROMOVE

Equipped VAROBOXEs and VAROiBOXEs:

Select from more than 170 industry-specific assortments from page 18/640.

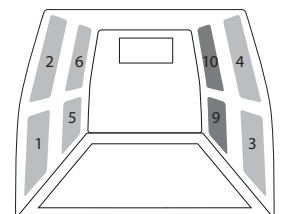

Base Module 34-50 **VAROMOBIL**

- 1x Shelf tray
- 1x Shelf tray with rim
- 1x Shelf including pull-out rails for 1x VAROBOXX and 1x VAROsBOXX (VARO(s)BOXX not included in delivery)
- Module dimensions (D x H x W): 370 x 876 x 762 mm
- Shelf tray, internal dimensions (D x W): 333.4 x 697 mm
- Shelf tray, load capacity: max. 80 kg
- Shelf with rim, internal dimensions (D x W): 232 x 702 mm
- Shelf with rim, load capacity: max. 50 kg
- Assembly material included in delivery

Article No.	Article Description	QTY
9009 34 50	VAROMOBIL BASE MODULE 34-50	1



Base Module Premium 34-50 **VAROMOBIL**

- 1x Shelf tray
- 1x Shelf with rim
- 1x Shelf including pull-out rails for 1x VAROBOXX and 1x VAROsBOXX (VARO(s)BOXX not included in delivery)
- 1x Drawer 34 with height 6
- 1x Shelf flap, height: 136 mm
- Module dimensions (D x H x W): 370 x 876 x 762 mm
- Shelf tray, internal dimensions (D x W): 333.4 x 697 mm
- Shelf tray, load capacity: max. 80 kg
- Shelf with rim, internal dimensions (D x W): 232 x 702 mm
- Shelf with rim, load capacity: max. 50 kg
- Drawer dimensions(D x W): 314.4 x 660.4 mm
- Drawer load capacity: max. 30 kg
- Assembly material included in delivery

Article No.	Article Description	QTY
9009 34 50 1	VAROMOBIL PREMIUM MODULE 34-50	1



Base Module 44–50 **VAROMOBIL**

- 1x Shelf tray
- 1x Shelf with rim
- 1x Shelf including pull-out rails for 2 VAROBOXXes (VAROBOXXes not included in delivery)
- Module dimensions (D×H×W): 370 × 876 × 1,004 mm
- Shelf tray, internal dimensions (D×W): 333.4 × 939 mm
- Shelf tray, load capacity: max. 80 kg
- Shelf with rim, internal dimensions (D×W): 336 × 944 mm
- Shelf with rim, load capacity: max. 50 kg
- Assembly material included in delivery



Article No.	Article Description	QTY
9009 44 50	VAROMOBIL BASE MODULE 44-50	1

Base Module Premium 44–50 **VAROMOBIL**

- 1x Shelf tray
- 1x Shelf tray with rim
- 1x Shelf including pull-out rails for 3 flat VAROsBOXXes and 1 VAROBOXX (VARO(s)BOXXes not included in delivery)
- 1x Drawer 44 with height 6
- 1x Shelf flap, height: 136 mm
- Module dimensions (D × H × W): 370 × 876 × 1,004 mm
- Shelf tray, internal dimensions (D × W): 333.4 × 939 mm
- Shelf tray, load capacity: max. 80 kg
- Shelf with rim, internal dimensions (D × W): 336 × 944 mm
- Shelf with rim, load capacity: max. 50 kg
- Drawer dimensions(D × W): 314.4 × 902.4 mm
- Drawer load capacity: max. 30 kg
- Assembly material included in delivery



Article No.	Article Description	QTY
9009 44 50 1	VAROMOBIL PREMIUM MODULE 44-50	1

Modulpaket C:

Installation Driver's side:

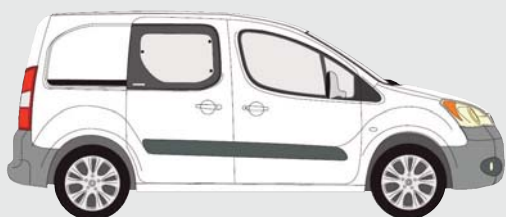

Module 44 – 60

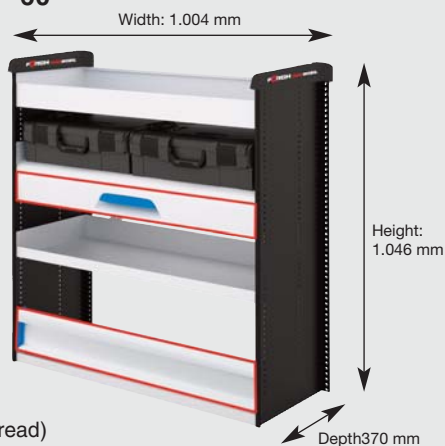

(PT = partial thread)

Installation Passenger's side:

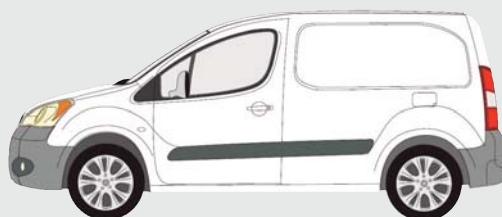

	Basis block	Weight
Basic module:	Art. No. 9009 44 60 1	approx 21 kg
Premium module:	Art. No. 9009 44 60 3	approx 28 kg

(PT = partial thread)

Select your individual modular equipment:

Basic module or premium module (incl. drawer and shelf flap)

You can add further drawers and shelf flaps in different heights, as well as more shelves and shelf tank bottoms to your vehicle equipment (see accessories from Page 18/890).

Floors and side panels:

For standard vans (without a window, bench, separating grid, etc. in the cargo space)

Model	from Model	Wheelbase	Excess length	Drive type	Height	Art. No. of floor	Art. No. of side panel	Image No.
Citroen Berlingo	2008	2.728 mm	-	Front	Normal	9011 331013232	9011 331013239	2, 4, 6
Citroen Berlingo	2008	2.728 mm	L2	Front	Normal	9011 331014401	9011 331013239	2, 4, 6
Peugeot Partner	2008	2.728 mm	-	Front	Normal	9011 331013232	9011 331013239	2, 4, 6
Peugeot Partner	2008	2.728 mm	L2	Front	Normal	9011 331014401	9011 331013239	2, 4, 6

Additional accessories:

Such as trays, hose holders or non-slip mats can be found from 18/928. All VAROMOBIL-accessories are compatible also with VAROMOVE

Equipped VAROBOXXes and VAROiBOXXes:

Select from more than 170 industry-specific assortments from page 18/640.

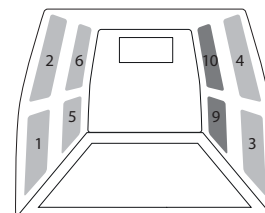

Modular package D:

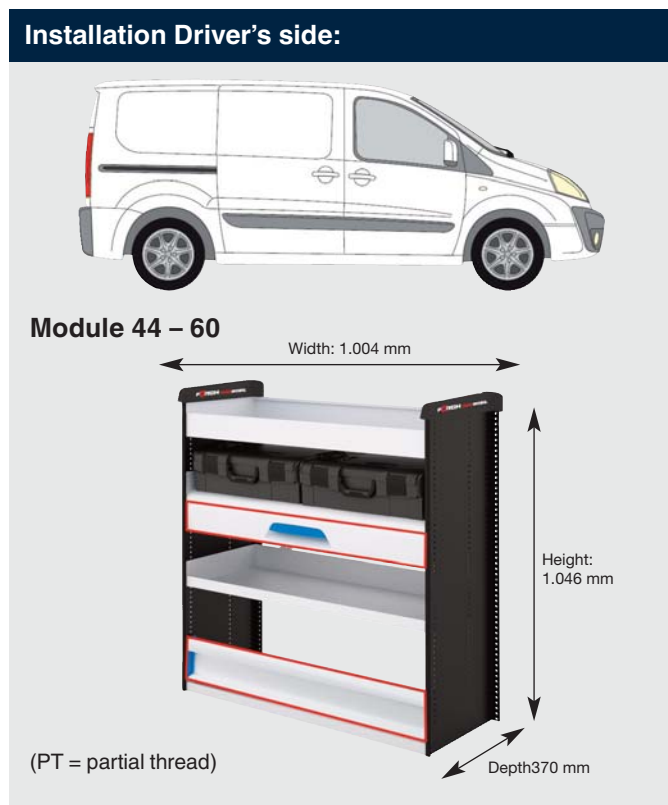

	Basis block	Weight
Basic module:	Art. No. 9009 44 60 1	approx 21 kg
Premium module:	Art. No. 9009 44 60 3	approx 28 kg

	Basis block	Weight
Basic module:	Art. No. 9009 44 60 1	approx 21 kg
Premium module:	Art. No. 9009 44 60 3	approx 28 kg

 (PT = partial thread)

Select your individual modular equipment:

Basic module or premium module (incl. drawer and shelf flap)

You can add further drawers and shelf flaps in different heights, as well as more shelves and shelf tank bottoms to your vehicle equipment (see accessories from Page 18/890).

Floors and side panels:

For standard vans (without a window, bench, separating grid, etc. in the cargo space)

Model	from Model	Wheelbase	Excess length	Drive type	Height	Art. No. of floor	Art. No. of side panel	Image No.
Citroen Jumpy	2007	3.000 mm	-	Front	Normal	9011 331011141	9011 331011223 9011 331011225	2, 4, 6 1, 3, 5
Citroen Jumpy	2016	2.925 mm	-	Front	Normal	9011 1000005157	9011 1000005160 9011 1000005159	2, 4, 6 1, 3, 5
Fiat Scudo	2007	3.000 mm	-	Front	Normal	9011 331011141	9011 331011223 9011 331011225	2, 4, 6 1, 3, 5
NissanNV200	2010	2.725 mm	-	Front	Normal	9011 331017186	9011 1000001830	2, 4, 6
Peugeot Expert	2007	3.000 mm	-	Front	Normal	9011 331011141	9011 331011223 9011 331011225	2, 4, 6 1, 3, 5
Peugeot Expert	2016	2.925 mm	-	Front	Normal	9011 1000005157	9011 1000005160 9011 1000005159	2, 4, 6 1, 3, 5
Toyota Proace	-	3.000 mm	-	Front	Normal	9011 331011141	9011 331011223 9011 331011225	2, 4, 6 1, 3, 5
Toyota Proace	2016	2.925 mm	-	Front	Normal	9011 1000005157	9011 1000005160 9011 1000005159	2, 4, 6 1, 3, 5

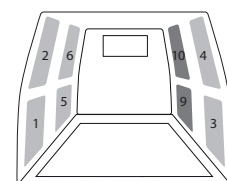

Modular package E:

Installation Driver's side:

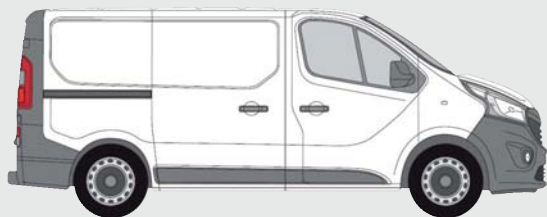

Module 44 – 60

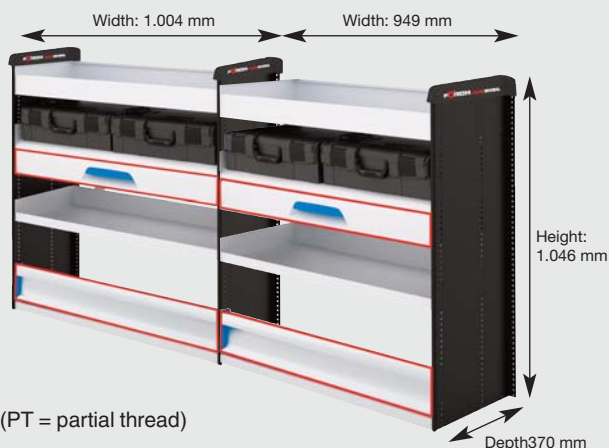

	Basis block	Weight
Basic module:	Art. No. 9009 44 60 1	approx 21 kg
Premium module:	Art. No. 9009 44 60 3	approx 28 kg
	Expansion module	Weight
Basic module:	Art. No. 9009 44 60 2	approx 17 kg
Premium module:	Art. No. 9009 44 60 4	approx 24 kg

Installation Passenger's side:

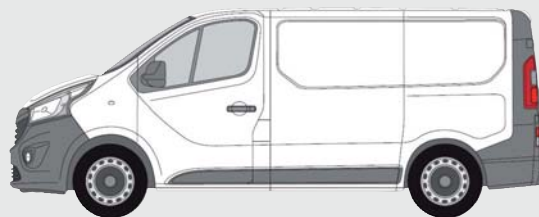

Module 44 – 60



	Basis block	Weight
Basic module:	Art. No. 9009 44 60 1	approx 21 kg
Premium module:	Art. No. 9009 44 60 3	approx 28 kg

 (PT = partial thread)

Select your individual modular equipment:

Basic module or premium module (incl. drawer and shelf flap)

You can add further drawers and shelf flaps in different heights, as well as more shelves and shelf tank bottoms to your vehicle equipment (see accessories from Page 18/890).

Additional accessories:

Such as trays, hose holders or non-slip mats can be found from 18/928. All VAROMOBIL-accessories are compatible also with VAROMOVE

Equipped VAROBOXes and VAROiBOXes:

Select from more than 170 industry-specific assortments from page 18/640.

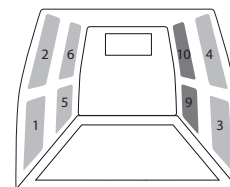

Modular package E:

Floors and side panels:

For standard vans (without a window, bench, separating grid, etc. in the cargo space)

Model	from Model	Wheelbase	Excess length	Drive type	Height	Art. No. of floor	Art. No. of side panel	Image No.
Citroen Jumpy	2007	3.122 mm	–	Front	Normal	9011 331011143	9011 331011224 9011 331011226	2, 4, 6 1, 3, 5
Citroen Jumpy	2016	3.275 mm	–	Front	Normal	9011 1000005112	9011 1000005095 9011 1000005094	2, 4, 6 1, 3, 5
Citroen Jumpy	2016	3.275 mm	L3	Front	Normal	9011 1000005158	9011 1000005162 9011 1000005161	2, 4, 6 1, 3, 5
Fiat Scudo	2007	3.122 mm	–	Front	Normal	9011 331011143	9011 331011224 9011 331011226	2, 4, 6 1, 3, 5
Fiat Talento	2014	3.098 mm	–	Front	Normal	9011 1000003017	9011 1000003043	1 – 6
Fiat Talento	2014	3.498	–	Front	Normal	9011 1000003023	9011 1000003249	1 – 6
Ford Custom	2012	2.933 mm	–	Front	Normal	9011 1000001761	9011 1000001582 9011 1000001585	1, 3, 5 2, 4, 6
Ford Custom	2012	3.300 mm	–	Front	Normal	9011 1000001764	9011 1000001791	2, 4, 6
Mercedes-Benz-Vito	2010	3.200 mm	L1	Front	Normal	9011 331017984	9011 33340412	1 – 6
Mercedes-Benz-Vito	2014	3.200 mm	L1	Front	Normal	9011 1000003158	9011 1000003161	1 – 6
Mercedes-Benz-Vito	2010	3.200 mm	L2	Front	Normal	9011 331017978	9011 33340405	1 – 6
Mercedes-Benz-Vito	2014	3.200 mm	L2	Front	Normal	9011 1000003159	9011 1000003162	1 – 6
Mercedes-Benz-Vito	2010	3.430 mm	–	Front	Normal	9011 331017981	9011 33340429	1 – 6
Mercedes-Benz-Vito	2014	3.430 mm	–	Front	Normal	9011 1000003160	9011 1000003163	1 – 6
Nissan NV300	2016	3.098	–	Front	Normal	9011 1000003017	9011 1000003043	1 – 6
Nissan NV300	2016	3.498	–	Front	Normal	9011 1000003023	9011 1000003249	1 – 6
Nissan NV300	2016	3.098	–	Front	High	9011 1000003017	9011 1000003043	1 – 6
Nissan NV300	2016	3.498	–	Front	High	9011 1000003023	9011 1000003249	1 – 6
Nissan Primastar	2001	3.098 mm	–	Front	Normal	9011 33572097	9011 33352088 9011 33352101	1 – 4 5, 6
Nissan Primastar	2001	3.498 mm	–	Front	Normal	9011 33572127	9011 33352095 9011 33352101	1 – 4 5, 6
Opel Vivaro (FT)	2001	3.098 mm	–	Front	Normal	9011 33572097	9011 33352088 9011 33352101	1 – 4 5, 6
Opel Vivaro (FT)	2014	3.098 mm	–	Front	Normal	9011 1000003017	9011 1000003043	1 – 6
Opel Vivaro (FT)	2001	3.498 mm	–	Front	Normal	9011 33572127	9011 33352095 9011 33352101	1 – 4 5, 6
Opel Vivaro (FT)	2014	3.498 mm	–	Front	Normal	9011 1000003023	9011 1000003249	1 – 6
Peugeot Expert	2007	3.122 mm	–	Front	Normal	9011 331011143	9011 331011224 9011 331011226	2, 4, 6 1, 3, 5
Peugeot Expert	2016	3.275 mm	–	Front	Normal	9011 1000005112	9011 1000005095 9011 1000005094	2, 4, 6 1, 3, 5
Peugeot Expert	2016	3.275 mm	L3	Front	Normal	9011 1000005158	9011 1000005162 9011 1000005161	2, 4, 6 1, 3, 5
Renault Trafic (FT)	2001	3.098 mm	–	Front	Normal	9011 33572097	9011 33352088 9011 33352101	1 – 4 5, 6
Renault Trafic (FT)	2014	3.098 mm	–	Front	Normal	9011 1000003017	9011 1000003043	1 – 6
Renault Trafic (FT)	2001	3.498 mm	–	Front	Normal	9011 33572127	9011 33352095 9011 33352101	1 – 4 5, 6
Renault Trafic (FT)	2014	3.498 mm	–	Front	Normal	9011 1000003023	9011 1000003249	1 – 6
Toyota Proace	–	3.122 mm	–	Front	Normal	9011 331011143	9011 331011224 9011 331011226	2, 4, 6 1, 3, 5
Toyota Proace	2016	3.275 mm	–	Front	Normal	9011 1000005112	9011 1000005095 9011 1000005094	2, 4, 6 1, 3, 5
Toyota Proace	2016	3.275 mm	L3	Front	Normal	9011 1000005158	9011 1000005162 9011 1000005161	2, 4, 6 1, 3, 5

Base Module 44–60 **VAROMOBIL**

- 1× Shelf tray
- 1× Shelf tray with rim
- 1× Shelf including pull-out rails for 2 VAROBOXXes (VAROBOXXes not included in delivery)
- Module dimensions (D × H × W): 370 × 1,046 × 1,004 mm
- Shelf tray, internal dimensions (D × W): 333.4 × 939 mm
- Shelf tray, load capacity: max. 80 kg
- Shelf with rim, internal dimensions (D × W): 336 × 944 mm
- Shelf with rim, load capacity: max. 50 kg
- Assembly material included in delivery

Article No.	Article Description	QTY
9009 44 60 1	VAROMOBIL BASE MODULE 44-60-1	1



Base Module Premium 44–60 **VAROMOBIL**

- 1× Shelf tray
- 1× Shelf tray with rim
- 1× Shelf including pull-out rails for 2 VAROBOXXes (VAROBOXXes not included in delivery)
- 1× Drawer 44 with height 6
- 1× Shelf flap, height: 136 mm
- Module dimensions (D × H × W): 370 × 1,046 × 1,004 mm
- Shelf tray, internal dimensions (D × W): 333.4 × 939 mm
- Shelf tray, load capacity: max. 80 kg
- Shelf with rim, internal dimensions (D × W): 336 × 944 mm
- Shelf with rim, load capacity: max. 50 kg
- Drawer dimensions (D × W): 314.4 × 902.4 mm
- Drawer load capacity: max. 30 kg
- Assembly material included in delivery

Article No.	Article Description	QTY
9009 44 60 3	VAROMOBIL PREMIUM MODULE 44-60	1



Extension Module 44–60 **VAROMOBIL**

- 1× Shelf tray
- 1× Shelf with rim
- 1× Shelf including pull-out for 2 VAROBOXXes (VAROBOXXes not included in delivery)
- Module dimensions (D × H × W): 370 × 1,046 × 949 mm
- Shelf tray, internal dimensions (D × W): 333.4 × 939 mm
- Shelf tray, load capacity: max. 80 kg
- Shelf with rim, internal dimensions (D × W): 336 × 944 mm
- Shelf with rim, load capacity: max. 50 kg
- Assembly material included in delivery

Article No.	Article Description	QTY
9009 44 60 2	VAROMOBIL EXTENS.MODULE44-60-2	1



Extension Module Premium 44-60 **VAROMOBIL**

- 1× Shelf tray
- 1× Shelf with rim
- 1× Shelf including pull-out rails for 2 VAROBOXXes (VAROBOXXes not included in delivery)
- 1× Drawer 44 with height 6
- 1× Shelf flap, height: 136 mm
- Module dimensions (D × H × W): 370 × 1,046 × 949 mm
- Shelf tray, internal dimensions (D × W): 333.4 × 939 mm
- Shelf tray, load capacity: max. 80 kg
- Shelf with rim, internal dimensions (D × W): 336 × 944 mm
- Shelf with rim, load capacity: max. 50 kg
- Drawer dimensions (D × W): 314.4 × 902.4 mm
- Drawer load capacity: max. 30 kg
- Assembly material included in delivery

Article No.	Article Description	QTY
9009 44 60 4	VAROMOBIL PREM.EXT.MOD.44-60	1



Modular package F:

Installation Driver's side:

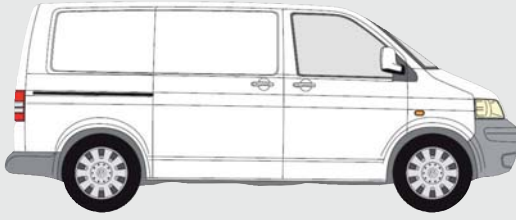

Module 44 – 60 TSU

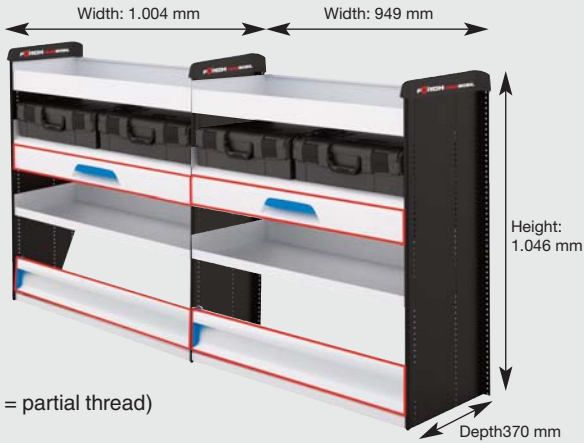

	Basis block	Weight
Basic module:	Art. No. 9009 44 60	approx 21 kg
Premium module:	Art. No. 9009 44 60 5	approx 28 kg
	Expansion module	Weight
Basic module:	Art. No. 9009 44 60 2	approx 17 kg
Premium module:	Art. No. 9009 44 60 4	approx 24 kg

Installation Passenger's side:

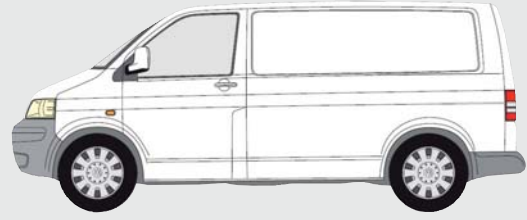

Module 44 – 60 TSU



	Basis block	Weight
Basic module:	Art. No. 9009 44 60	approx 21 kg
Premium module:	Art. No. 9009 44 60 5	approx 28 kg

 (PT = partial thread)

Select your individual modular equipment:

Basic module or premium module (incl. drawer and shelf flap)

You can add further drawers and shelf flaps in different heights, as well as more shelves and shelf tank bottoms to your vehicle equipment (see accessories from Page 18/890).

Floors and side panels:

For standard vans (without a window, bench, separating grid, etc. in the cargo space)

Model	from Model	Wheelbase	Excess length	Drive type	Height	Art. No. of floor	Art. No. of side panel	Image No.
VW T5/T6	2003	3.000 mm	–	Front	Normal	9011 33592156	9011 33341303	1 – 6
VW T5/T6	2003	3.400 mm	–	Front	Normal	9011 33592149	9011 331001287	1 – 6

Additional accessories:

Such as trays, hose holders or non-slip mats can be found from 18/928. All VAROMOBIL-accessories are compatible also with VAROMOVE

Equipped VAROBOXXes and VAROIBOXXes:

Select from more than 170 industry-specific assortments from page 18/640.

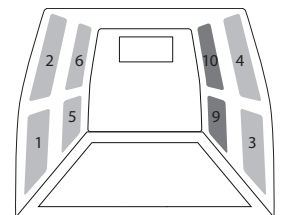

Base Module 44-60 TSU **VAROMOBIL**

- Wheel arch cut-out at base on one side, for optimising depth
- 1x Shelf tray
- 1x Shelf with rim
- 1x Shelf including pull-out rails for 2 VAROBOXXes (VAROBOXXes not included in delivery)
- Module dimensions (D x H x W): 370 x 1,046 x 1,004 mm
- Shelf tray, internal dimensions (D x W): 333.4 x 939 mm
- Shelf tray, load capacity : max. 80 kg
- shelf with rim, internal dimensions (D x W): 336 x 944 mm
- shelf with rim, load capacity: max. 50 kg
- Assembly material included in delivery



Article No.	Article Description	QTY
9009 44 60	VAROMOBIL BASE MODULE 44-60TSU	1

Base Module Premium 44-60 TSU **VAROMOBIL**

- Wheel arch cut-out at base on one side, for optimising depth
- 1x Shelf tray
- 1x Shelf with rim
- 1x Shelf including pull-out rails for 2 VAROBOXXes (VAROBOXXes not included in delivery)
- 1x Drawer 44 with height 6
- 1x Shelf flap, height: 136 mm
- Module dimensions (D x H x W): 370 x 1,046 x 1,004 mm
- Shelf tray, internal dimensions (D x W): 333.4 x 939 mm
- Shelf tray, load capacity: max. 80 kg
- Shelf with rim, internal dimensions (D x W): 336 x 944 mm
- Shelf with rim, load capacity: max. 50 kg
- Drawer dimensions: 314.4 x 902.4 mm
- Drawer load capacity: max. 30 kg
- Assembly material included in delivery



Article No.	Article Description	QTY
9009 44 60 5	VAROMOBIL PREM.MODULE44-60 TSU	1

Modular package G:

Installation Driver's side:

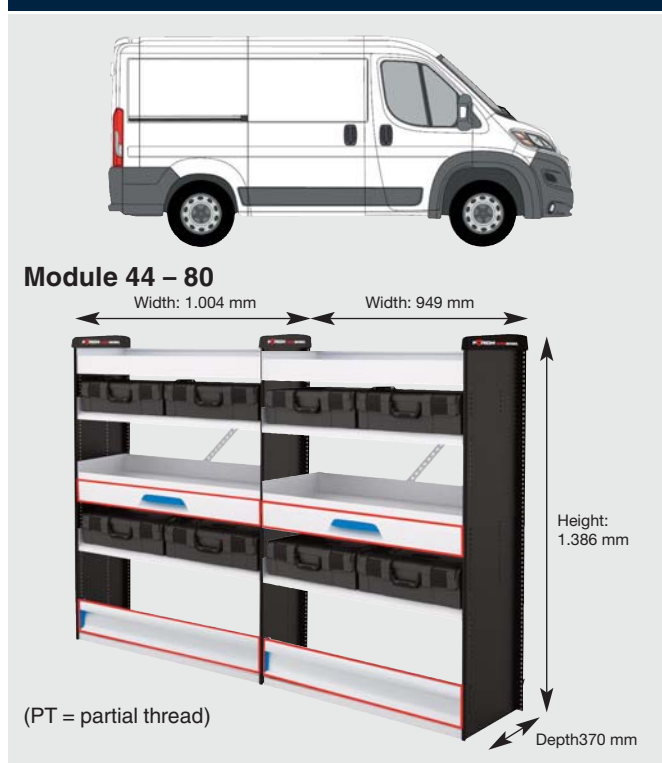

	Basis block	Weight
Basic module:	Art. No. 9009 44 80 1	approx 27 kg
Premium module:	Art. No. 9009 44 80 3	approx 34 kg
	Expansion module	Weight
Basic module:	Art. No. 9009 44 80 2	approx 24 kg
Premium module:	Art. No. 9009 44 80 4	approx 30 kg

Installation Passenger's side:

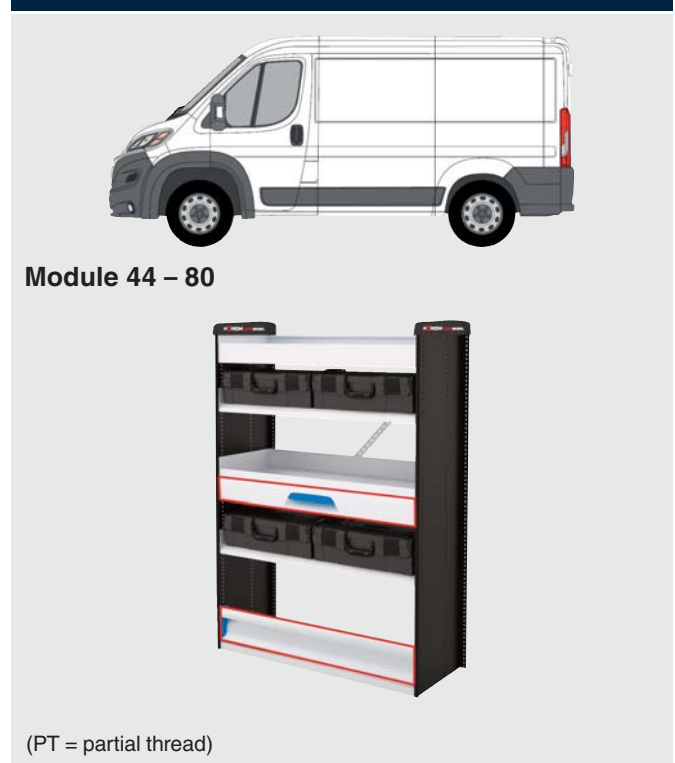

	Basis block	Weight
Basic module:	Art. No. 9009 44 80 1	approx 27 kg
Premium module:	Art. No. 9009 44 80 3	approx 34 kg

□ (PT = partial thread)

Select your individual modular equipment:

Basic module or premium module (incl. drawer and shelf flap)

You can add further drawers and shelf flaps in different heights, as well as more shelves and shelf tank bottoms to your vehicle equipment (see accessories from Page 18/890).

Floors and side panels:

For standard vans (without a window, bench, separating grid, etc. in the cargo space)

Model	from Model	Wheelbase	Excess length	Drive type	Height	Art. No. of floor	Art. No. of side panel	Image No.
Citroen Jumper	2006	3.000 mm	-	Front	Normal Middle	9011 331010270	9011 331010560 9011 1000000148	1-6 1-6
Fiat Ducato	2006	3.000 mm	-	Front	Normal Middle	9011 331010270	9011 331010560 9011 1000000148	1-6 1-6
Iveco Daily	2014	3.000 mm	-	Front	Normal	-	-	-
Mercedes-Benz Sprinter	2006	3.250 mm	-	Front	Normal	9011 331008871	9011 331009617	1-6 1-6
Nissan NV400	2012	3.182 mm	-	Front	Normal Middle	9011 331016911	9011 1000001044 9011 1000001045	1-6 1-6
Opel Movano	2010	3.182 mm	-	Front	Normal Middle	9011 331016911	9011 1000001044 9011 1000001045	1-6 1-6
Peugeot Boxer	2006	3.000 mm	-	Front	Normal Middle	9011 331010270	9011 331010560 9011 1000000148	1-6 1-6
Renault Master	2010	3.182 mm	-	Front	Normal Middle	9011 331016911	9011 1000001044 9011 1000001045	1-6 1-6
VW Crafter	2006	3.250 mm	-	Front	Normal	9011 331008871	9011 331009617	1-6

(Continued on next page)

Additional accessories:

Such as trays, hose holders or non-slip mats can be found from 18/928.
All VAROMOBIL-accessories are compatible also with VAROMOVE

Equipped VAROBOXXes and VAROiBOXXes:

Select from more than 170 industry-specific assortments from page 18/640.

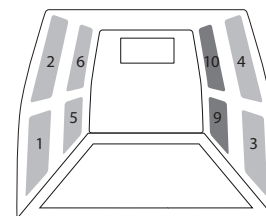

Base Module 44-80 **VAROMOBIL**

- 1x Shelf tray
- 1x Shelf with rim
- 2x Shelf including pull-out rails for 2 VAROBOXXes (VAROBOXXes not included in delivery)
- Module dimensions (D x H x W): 370 x 1,386 x 1,004 mm
- Shelf tray, internal dimensions (D x W): 333.4 x 939 mm
- Shelf tray, load capacity: max. 80 kg
- Shelf with rim, internal dimensions (D x W): 336 x 944 mm
- Shelf with rim, load capacity: max. 50 kg
- Assembly material included in delivery



Article No.	Article Description	QTY
9009 44 80 1	VAROMOBIL BASE MODULE 44-80-1	1

Base Module Premium 44-80 **VAROMOBIL**

- 1x Shelf tray
- 1x Shelf with rim
- 2x Shelf including pull-out rails for 2 VAROBOXXes (VAROBOXXes not included in delivery)
- 1x Drawer 44 with height 6
- 1x Shelf flap, height: 136 mm
- Module dimensions (D x H x W): 370 x 1,386 x 1,004 mm
- Shelf tray, internal dimensions (D x W): 333.4 x 939 mm
- Shelf tray, load capacity: max. 80 kg
- Shelf with rim, internal dimensions (D x W): 336 x 944 mm
- Shelf with rim, load capacity: max. 50 kg
- Drawer dimensions (D x W) 314.4 x 902.4 mm
- Drawer load capacity: max. 30 kg
- Assembly material included in delivery



Article No.	Article Description	QTY
9009 44 80 3	VAROMOBIL PREM.MODULE 44-80-1	1

Extension Module 44-80 **VAROMOBIL**

- 1× Shelf tray
- 1× Shelf with rim
- 2× Shelf including pull-out rails for 2 VAROBOXXes (VAROBOXXes not included in delivery)
- Module dimensions (D × W × H): 370 × 1,386 × 949 mm
- shelf tray, internal dimensions (D × W): 333.4 × 939 mm
- shelf tray, load capacity: max. 80 kg
- shelf with rim, internal dimensions (D × W): 336 × 944 mm
- Shelf with rim, load capacity: max. 50 kg
- Assembly material included in delivery

Article No.	Article Description	QTY
9009 44 80 2	VAROMOBIL EXT.MODULE 44-80-2	1



Extension Module Premium 44-80 **VAROMOBIL**

- 1× Shelf tray
- 1× Shelf with rim
- 2× Shelf including pull-out rails for VAROBOXXes (VAROBOXXes not included in delivery)
- 1× Drawer 44 with height 6
- 1× Shelf flap, height: 136 mm
- Module dimensions(D × H × W): 370 × 1,386 × 949 mm
- Shelf tray, internal dimensions (D × W): 333.4 × 939 mm
- Shelf tray, load capacity: max. 80 kg
- shelf with rim, internal dimensions (D × W): 336 × 944 mm
- shelf with rim, load capacity: max. 50 kg
- Drawer dimensions (D × W): 314.4 × 902.4 mm
- Drawer load capacity: max. 30 kg
- Assembly material included in delivery

Article No.	Article Description	QTY
9009 44 80 4	VAROMOBIL PREM.EXT.MOD.44-80	1



Modular package H:

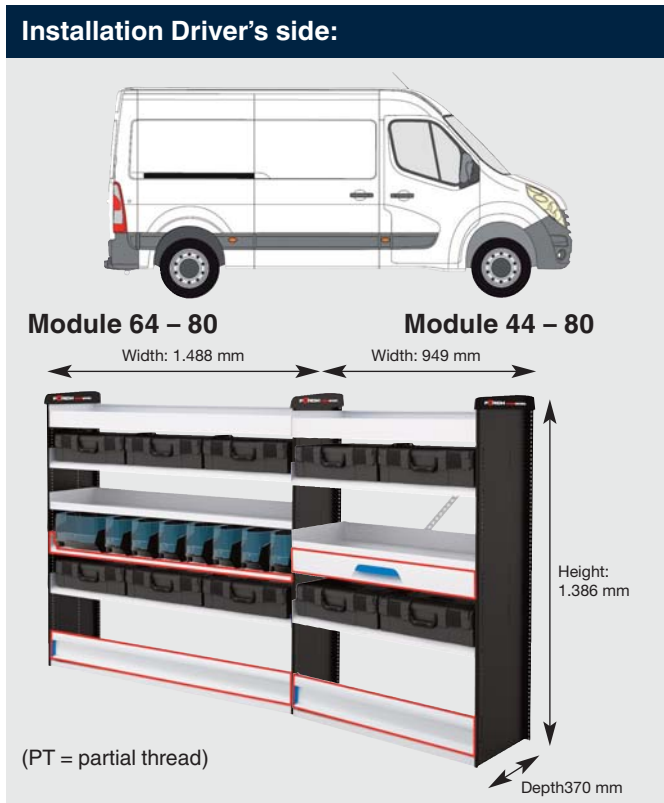

	Basis block	Weight
Basic module:	Art. No. 9009 64 80 1	approx 34 kg
Premium module:	Art. No. 9009 64 80 3	approx 42 kg
	Expansion module	Weight
Basic module:	Art. No. 9009 44 80 2	approx 24 kg
Premium module:	Art. No. 9009 44 80 4	approx 30 kg

	Basis block	Weight
Basic module:	Art. No. 9009 44 80 1	approx 27 kg
Premium module:	Art. No. 9009 44 80 3	approx 34 kg

□ (PT = partial thread)

Select your individual modular equipment:

Basic module or premium module (incl. drawer and shelf flap)

You can add further drawers and shelf flaps in different heights, as well as more shelves and shelf tank bottoms to your vehicle equipment (see accessories from Page 18/890).

Floors and side panels:

For standard vans (without a window, bench, separating grid, etc. in the cargo space)

Model	from Model	Wheelbase	Excess length	Drive type	Height	Art. No. of floor	Art. No. of side panel	Image No.
Citroen Jumper	2006	3.450 mm	-	Front	Normal	9011 351014681	9011 331010820	1 - 6
							9011 331010562	1 - 6
Fiat Ducado	2006	3.450 mm	-	Front	Normal	9011 331010272	9011 331010820	1 - 6
							9011 331010562	1 - 6
Nissan NV400	2012	3.682 mm	-	Front	Medium	9011 331016912	9011 331017076	1 - 6
Nissan NV400	2012	3.682 mm	-	Rear	Medium	9011 331016843	9011 331017083	1 - 6
Opel Movano	2010	3.682 mm	-	Front	Medium	9011 331016912	9011 331017076	1 - 6
Opel Movano	2010	3.682 mm	-	Rear	Medium	9011 331016843	9011 331017083	1 - 6
Peugeot Boxer	2006	3.450 mm	-	Front	Normal	9011 351014681	9011 331010820	1 - 6
					Medium		9011 331010562	1 - 6
Renault Master	2010	3.682 mm	-	Front	Medium	9011 331016912	9011 331017076	1 - 6
Renault Master	2010	3.682 mm	-	Rear	Medium	9011 331016843	9011 331017083	1 - 6

Additional accessories:

Such as trays, hose holders or non-slip mats can be found from 18/928.

All VAROMOBIL-accessories are compatible also with VAROMOVE

Equipped VAROBOXes and VAROiBOXes:

Select from more than 170 industry-specific assortments from page 18/640.

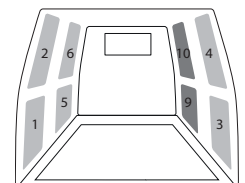

Modular package I:

Installation Driver's side:

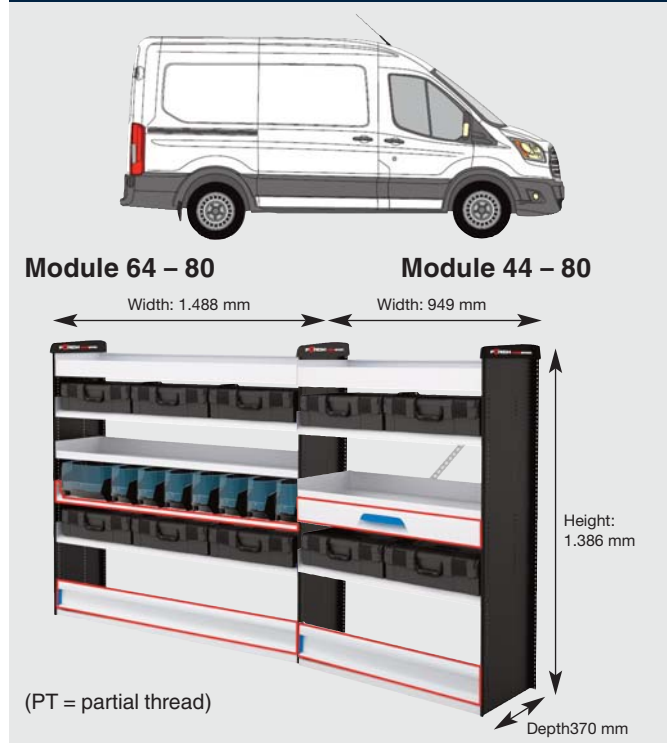

	Basis block	Weight
Basic module:	Art. No. 9009 64 80 1	approx 34 kg
Premium module:	Art. No. 9009 64 80 3	approx 42 kg
	Expansion module	Weight
Basic module:	Art. No. 9009 44 80 2	approx 24 kg
Premium module:	Art. No. 9009 44 80 4	approx 30 kg

Installation Passenger's side:

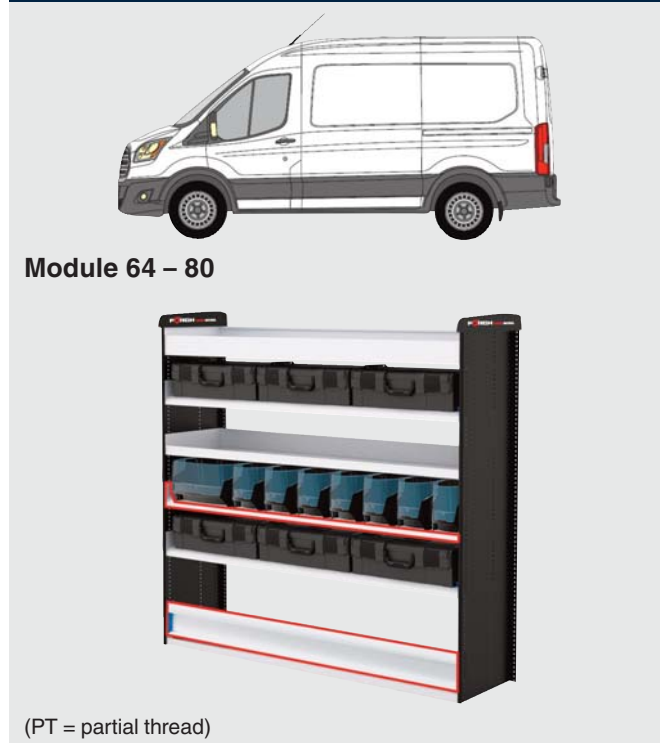

	Basis block	Weight
Basic module:	Art. No. 9009 64 80 1	approx 34 kg
Premium module:	Art. No. 9009 64 80 3	approx 42 kg

 (PT = partial thread)

Select your individual modular equipment:

Basic module or premium module (incl. drawer and shelf flap)

You can add further drawers and shelf flaps in different heights, as well as more shelves and shelf tank bottoms to your vehicle equipment (see accessories from Page 18/890).

Floors and side panels:

For standard vans (without a window, bench, separating grid, etc. in the cargo space)

Model	from Model	Wheelbase	Excess length	Drive type	Height	Art. No. of floor	Art. No. of side panel	Image No.
Ford Transit	2014	3.300 mm	-	Front	Normal	9011 1000002680	9011 1000002687	1 - 6
Ford Transit	2014	3.300 mm	-	Rear	Normal	9011 1000002873	9011 1000002687	1 - 6
Iveco Daily	2014	3.520 mm	-	Front	Medium	9011 1000002757	-	-
MAN TGE	2016	3.640 mm	-	Front	Normal	9011 1000005278	-	-
MAN TGE	2016	3.640 mm	-	Front	Medium	-	-	-
MAN TGE	2016	3.640 mm	-	Rear	Normal	-	-	-
VW Crafter	2016	3.640 mm	-	Front	Normal	9011 1000005278	-	-
VW Crafter	2016	3.640 mm	-	Front	Medium	-	-	-
VW Crafter	2016	3.640 mm	-	Rear	Normal	-	-	-

Additional accessories:

Such as trays, hose holders or non-slip mats can be found from 18/928. All VAROMOBIL-accessories are compatible also with VAROMOVE

Equipped VAROBOXEs and VAROiBOXEs:

Selec from more than 170 industry-specific assortments from page 18/640.

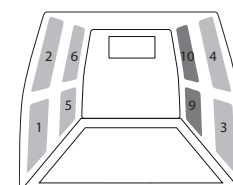

Modular package J:

Installation Driver's side:

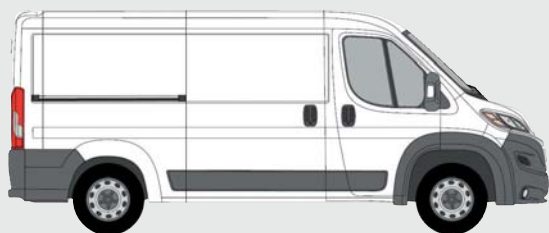

Module 64 – 80

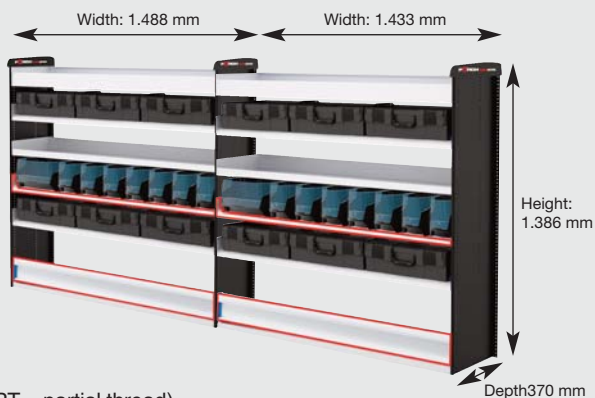

(PT = partial thread)

	Basis block	Weight
Basic module:	Art. No. 9009 64 80 1	approx 34 kg
Premium module:	Art. No. 9009 64 80 3	approx 42 kg
	Expansion module	Weight
Basic module:	Art. No. 9009 64 80 2	approx 29 kg
Premium module:	Art. No. 9009 64 80 4	approx 37 kg

Installation Passenger's side:

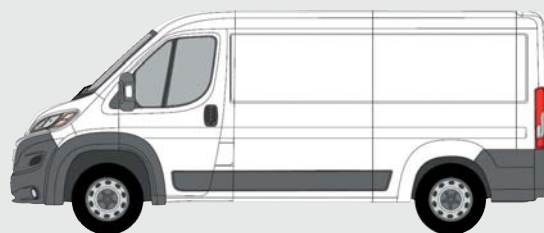

Module 64 – 80



(PT = partial thread)

	Basis block	Weight
Basic module:	Art. No. 9009 64 80 1	approx 34 kg
Premium module:	Art. No. 9009 64 80 3	approx 42 kg

 (PT = partial thread)

Select your individual modular equipment:

Basic module or premium module (incl. drawer and shelf flap)

You can add further drawers and shelf flaps in different heights, as well as more shelves and shelf tank bottoms to your vehicle equipment (see accessories from Page 18/890).

Floors and side panels:

For standard vans (without a window, bench, separating grid, etc. in the cargo space)

Floors and side panels:

For standard vans (without a window, bench, separating grid, etc. in the cargo space)

Model	from Model	Wheelbase	Excess length	Drive type	Height	Art. No. of floor	Art. No. of side panel	Image No.
Citroen Jumper	2006	4.035 mm	-	Front	Medium	9011 331010274	9011 331010564	1 - 6
Fiat Ducato	2006	4.035 mm	-	Front	Medium	9011 331010274	9011 331010564	1 - 6
Ford Transit	2014	3.750 mm	L1	Front	Medium	9011 1000002649	9011 1000002654	1 - 6
Ford Transit	2014	3.750 mm	-	Rear	Medium	9011 1000002760	9011 1000002654	1 - 6
Iveco Daily	2014	3.520 mm	L	Front	Normal	9011 1000002758	9011 1000003334	1 - 6
Iveco Daily	2014	4.100 mm	-	Front	Normal	9011 1000002758	9011 1000003334	1 - 6
Iveco Daily	2014	4.100 mm	L	Front	Normal	9011 1000002758	9011 1000003334	1 - 6
MAN TGE	2016	4.490 mm	-	Rear	Medium	-	-	-
Mercedes-Benz Sprinter	2006	3.665 mm	-	Front	Medium	9011 331008873	9011 331009619	1 - 6
Mercedes-Benz Sprinter	2006	4.325 mm	L1	Front	Medium	9011 331009668	9011 331009659	1 - 6
Nissan NV400	2012	4.332 mm	-	Front	Medium	9011 331016913	9011 331017782	1 - 6
Opel Movano	2010	4.332 mm	-	Front	Medium	9011 331016913	9011 331017782	1 - 6
Peugeot Boxer	2006	4.035 mm	-	Front	Medium	9011 331010274	9011 331010564	1 - 6
Renault Master	2010	4.332 mm	-	Front	Medium	9011 331016913	9011 331017782	1 - 6
VW Crafter	2006	3.665 mm	L1	Front	Normal/Middle	9011 331008873	9011 331009619	1 - 6
VW Crafter	2006	4.325 mm	L1	Front	Medium	9011 331009668	9011 331009659	1 - 6
VW Crafter	2016	4.490 mm	-	Rear	Medium	-	-	-

Additional accessories:

Such as trays, hose holders or non-slip mats can be found from 18/928. All VAROMOBIL-accessories are compatible also with VAROMOVE

Equipped VAROBOXXes and VAROiBOXXes:

Select from more than 170 industry-specific assortments from page 18/640.

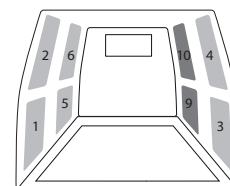

Base Module 64-80 **VAROMOBIL**

- 1x Shelf tray
- 1x Shelf with rim
- 2x Shelf including pull-out rails for respectively 3 VAROBOXXes (VAROBOXXes not included in delivery)
- Module dimensions (D x H x W): 370 x 1,386 x 1,488 mm
- Shelf tray, internal dimensions (D x W): 333.4 x 1,423 mm
- Shelf tray, load capacity: max. 80 kg
- Shelf with rim, internal dimensions (D x W): 336 x 1,428 mm
- Shelf with rim, load capacity: max. 50 kg
- Assembly material included in delivery

Article No.	Article Description	QTY
9009 64 80 1	VAROMOBIL BASE MODULE 64-80-1	1



Base Module Premium 64-80 **VAROMOBIL**

- 1x Shelf tray
- 1x Shelf with rim
- 2x Shelf including pull-out rails for 3 VAROBOXXes
- 1x Shelf for storing up to 9 VAROsBOXXes (VARO(s)BOXXes not included in delivery)
- 1x Shelf flap, height: 136 mm
- Module dimensions (D x H x W): 370 x 1,386 x 1,488 mm
- Shelf tray, internal dimensions (D x W): 333.4 x 1,423 mm
- shelf tray, load capacity: max. 80 kg
- Shelf with rim, internal dimensions (D x W): 336 x 1,428 mm
- Shelf with rim, load capacity: max. 50 kg
- Assembly material included in delivery

Article No.	Article Description	QTY
9009 64 80 3	VAROMOBIL PREM.MODULE 64-80	1



Extension Module 64-80 **VAROMOBIL**

- 1x shelf tray
- 1x shelf with rim
- 2x Shelf including pull-out rails for 3 VAROBOXXes (VAROBOXXes not included in delivery)
- Module dimensions (D x H x W): 370 x 1,386 x 1,433 mm
- shelf tray, internal dimensions (D x W): 333.4 x 1,423 mm
- shelf tray, load capacity: max. 80 kg
- Shelf with rim, internal dimensions (D x W): 336 x 1,428 mm
- Shelf with rim, load capacity: max. 50 kg
- Assembly material included in delivery

Article No.	Article Description	QTY
9009 64 80 2	VAROMOBIL EXT.MODULE 64-80-2	1



Extension Module Premium 64-80 **VAROMOBIL**

- 1x Shelf tray
- 1x Shelf with rim
- 2x Shelf including pull-out rails for 3 VAROBOXXes
- 1x Shelf for storing up to 9 VAROsBOXXes (VARO(s)BOXXes not included in delivery)
- 1x Shelf flap, height: 136 mm
- Module dimensions (D x H x W),: 370 x 1,386 x 1,433 mm
- shelf tray, internal dimensions (D x W): 333.4 x 1,423 mm
- shelf tray, load capacity: max. 80 kg
- shelf with rim, internal dimensions (D x W): 336 x 1,428 mm
- shelf with rim, load capacity: max. 50 kg
- Assembly material included in delivery

Article No.	Article Description	QTY
9009 64 80 4	VAROMOBIL EXT.PREM.MOD. 64-80	1



Drawers B34 **VAROMOBIL**

- Drawer with user-friendly grip recess
- Integrated locking
- load-bearing up to 30 kg
- For mounting it is required to have a telescopic rail right (Art. No. 9012 36) and left (Art. No. 9012 36 1) and mounting screw set (Art. No. 9012 36 2)
- Max. two drawers for each modul

Technical Data

Art. No.	Drawer inner dimensions (D x W x H):
9012 34 6	315 x 660 x 90 mm
9012 34 8	315 x 660 x 124 mm
9012 34 10	315 x 660 x 158 mm
9012 34 12	315 x 660 x 192 mm



Article No.	Article Description	QTY
9012 34 6	VAROMOBIL DRAWER 34-6	1
9012 34 8	VAROMOBIL DRAWER 34-8	1
9012 34 10	VAROMOBIL DRAWER 34-10	1
9012 34 12	VAROMOBIL DRAWER 34-12	1
9012 36	VAROMOBIL TELES.RAIL DR.RIGHT	1
9012 36 1	VAROMOBIL TELES.RAIL DR.LEFT	1
9012 36 2	VAROMOBIL SCREW SET DRAWER	1

Drawers B44 **VAROMOBIL**

- Drawer with user-friendly grip recess
- Integrated locking
- Load-bearing up to 30 kg
- For mounting it is required to have the telescopic rail right (Art. No. 9012 36) and left (Art. No. 9012 36 1) and the mounting screw set (Art. No. 9012 36 2)
- Max. two drawers for each modul

Technical Data

Art. No.	Drawer inner dimensions (D x W x H):
9012 44 6	315 x 890 x 90 mm
9012 44 8	315 x 890 x 124 mm
9012 44 10	315 x 890 x 158 mm
9012 44 12	315 x 890 x 192 mm

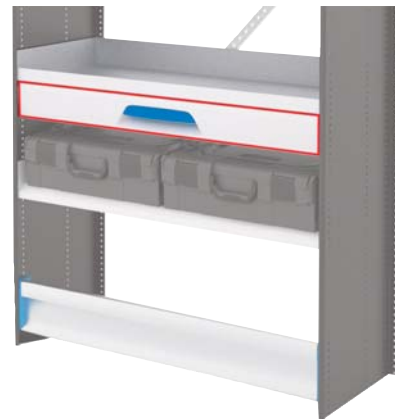

Article No.	Article Description	QTY
9012 44 6	VAROMOBIL DRAWER 44-6	1
9012 44 8	VAROMOBIL DRAWER 44-8	1
9012 44 10	VAROMOBIL DRAWER 44-10	1
9012 44 12	VAROMOBIL DRAWER 44-12	1
9012 36	VAROMOBIL TELES.RAIL DR.RIGHT	1
9012 36 1	VAROMOBIL TELES.RAIL DR.LEFT	1
9012 36 2	VAROMOBIL SCREW SET DRAWER	1



Partition Set Drawer B34 **VAROMOBIL**

- For drawers with module width 3
- Different grid systems for dividing the drawers

Technical Data

Art.No.:	for drawers height
9012 29	6
9012 34 8 1	8
9012 34 10 12	10/12

Article No.	Article Description	QTY
9012 29	VAROMOBIL DRAWER PARTITION34-6	1
9012 34 8 1	VAROMOBIL DRAWER PARTITION34-8	1
9012 34 10 12	VAROMOBIL DRAW.PART.34-10/12	1

Contents:

- 1 x Partition plate
- 2 x Slot dividers
- 5 x Drawer partition plate holders
- 2 x Adapters for slot dividers



Partition Set Drawer B44 **VAROMOBIL**

- For drawers with module width 4
- Different grid systems for dividing the drawers

Technical Data

Art. No.:	for drawers height
9012 30	6
9012 44 8 1	8
9012 44 10 12	10/12

Article No.	Article Description	QTY
9012 30	VAROMOBIL DRAW.PARTITION 44-6	1
9012 44 8 1	VAROMOBIL DRAW.PARTITION 44-8	1
9012 44 10 12	VAROMOBIL DRAW.PART.44-10/12	1

Contents:

- 1x Partition plate
- 2x Slot dividers
- 5x Drawer partition plate holders
- 2x Adapters for slot dividers

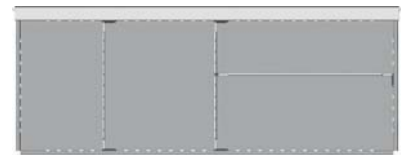

Anti-Slip Mat for Drawer 34 **VAROMOBIL**

Art. No. 9012 27:

- For drawer module 34

Art. No. 9012 28:

- For drawer module 44

Article No.	Article Description	QTY
9012 27	VAROMOBIL ANTI-SL.M.DRAWER 34	1
9012 28	VAROMOBIL ANTI-SL.M.DRAWER 44	1

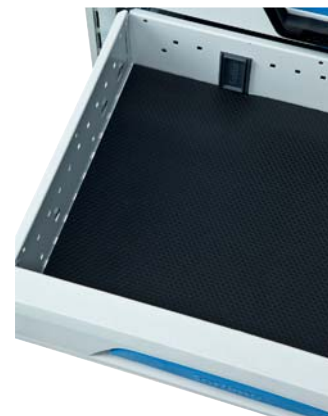

Long Storage Tray with Cover **VAROMOBIL**

- Suitable for the transport of long freight cargo in vehicle interiors
- Cover with space-saving sliding mechanism
- Made of light composite material
- Available in lengths of 2.0/2.5 and 3.0 metres
- **VAROMOBIL Long Storage Tray Console (3× Art. No. 9012 9 2) and mounting material (rivets, screws, etc.) are needed for mounting the long storage tray on the side wall of a vehicle.**



Article No.	Article Description	QTY
9012 9	VAROMOBIL MOUNT.ANGLES	1
9012 9 2	VAROMOBIL LONG STOR.TR.CONSOLE	1
9012 9 1	VAROMOBIL SCEW KIT	1
9012 44 9 1	VAROMOBIL LST - REAR B4	1
9012 44 9	VAROMOBIL LST - FRONT PART B4	1
9012 64 9 1	VAROMOBIL LST - REAR B6	1
9012 64 9	VAROMOBIL LST - FRONT PART B6	1

Possible build variants are shown on the next page.

Possible design variations of the long storage tray with basic and expansion modules

Sample variation 1

Base module 44 – 60 and extension module 44 – 60
Base module 44 – 80 and extension module 44 – 80

Block 44 – XX **Block 44 – XX**

Length: approx. 2.000 mm

Driving direction →

The following articles and quantities are required for installation of the long storage tray

Art. No.	amount	Article Description
9012 9	3	Simpleco 3.0 fastener Bracket LGW T4
9012 9 1	1	Simpleco 3.0 SSA LGW 2 fields
9012 44 9	1	Long product tray Composite B4 front part
9012 44 9 1	1	Long prod.tray Comp.B4 rear part w.cover

Sample variation 2

Base module 44 – 80 and extension module 64 – 80

Block 44 – XX **Block 64 – XX**

Length: approx. 2.500 mm

Driving direction →

The following articles and quantities are required for installation of the long storage tray

Art. No.	amount	Article Description
9012 9	3	Simpleco 3.0 fastener Bracket LGW T4
9012 9 1	1	Simpleco 3.0 SSA LGW 2 fields
9012 64 9	1	Long product tray Composite B6 front part
9012 44 9 1	1	Long product tray Composite B6 front part

Sample variation 3

Base module 64 – 80 and extension module 44 – 80

Block 64 – XX **Block 44 – XX**

Length: approx. 2.500 mm

Driving direction →

The following articles and quantities are required for installation of the long storage tray:

Art. No.	amount	Article Description
9012 9	3	Simpleco 3.0 fastener Bracket LGW T4
9012 9 1	1	Simpleco 3.0 SSA LGW 2 fields
9012 44 9	1	Long product tray Composite B4 front part
9012 64 9 1	1	Long prod.tray Comp.B4 rear part w.cover

Sample variation 4

Base module 64 – 80 and extension module 64 – 80

Block 64 – XX **Block 64 – XX**

Length: approx. 3.000 mm

Driving direction →

The following articles and quantities are required for installation of the long storage tray:

Art. No.	amount	Article Description
9012 9	3	Simpleco 3.0 fastener Bracket LGW T4
9012 9 1	1	Simpleco 3.0 SSA LGW 2 fields
9012 64 9	1	Long product tray Composite B6 front part
9012 64 9 1	1	Long prod.tray Comp.B4 rear part w.cover

Shelf Tray **VAROMOBIL**

- For clear storage of tools and spare parts
- Tray bottom protected by anti-slip mat
- Edge height front: approx. 80 mm
- Can be divided into sections with the partition plate kit (Art. No. 9012 33)
- For mounting it is required to have the mounting screw kit (Art. No. 9012 37)

Technical Data

Art. No.	For module versions:	Interior dimensions (D x W)
9012 34 1	34	333,4 x 697 mm
9012 44 1	44	333,4 x 939 mm
9012 64 1	64	333,4 x 1.423 mm



Article No.	Article Description	QTY
9012 34 1	VAROMOBIL SHELF TRAY 34-7	1
9012 44 1	VAROMOBIL SHELF TRAY 44-7	1
9012 64 1	VAROMOBIL SHELF TRAY 64-7	1
9012 37	VAROMOBIL SCREW KIT	1

Partition Set Shelf Tray **VAROMOBIL**

- For dividing shelf tray into custom configuration
- For all modules
- Partition plate including two adapters

Article No.	Article Description	QTY
9012 33	VAROMOBIL PART.SET SHELF TRAY	1

Content:

- Partition plate, adapter front + back



Shelves with Rim **VAROMOBIL**

- For clear storage of tools and spare parts
- Tray bottom protected by anti-slip mat
- Edge height front: approx. 32 mm
- Can be divided into sections with the partition plate kit (Art. No. 9012 34)
- For mounting it is required to have the mounting screw kit (Art. No.: 9012 37)



Technical Data

Art. No.	for module versions:	Internal dimensions (D x W)
9012 34 2	34	232 x 702 mm
9012 44 2	44	336 x 944 mm
9012 64 2	64	336 x 1,428 mm

Article No.	Article Description	QTY
9012 34 2	VAROMOBIL SHELVES WITH RIM 34	1
9012 44 2	VAROMOBIL SHELVES WITH RIM 44	1
9012 64 2	VAROMOBIL SHELVES WITH RIM 64	1
9012 37	VAROMOBIL SCREW KIT	1

Partition Set for Shelf with Rim **VAROMOBIL**

- For dividing shelf with rim into custom configuration
- For all modules
- Partition plate including adapter
- Art. No. 9012 34 2 1 (partition holder) must be used for shelf with rim in basic modules 34 – 50 and 44 – 50

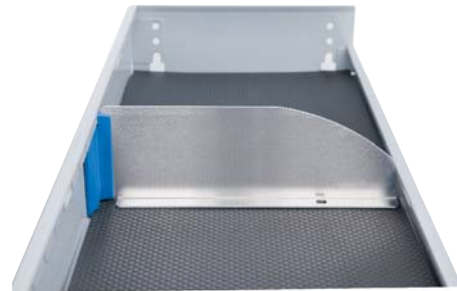

Article No.	Article Description	QTY
9012 34	VAROMOBIL PART.SET SHELF W.RIM	1
9012 34 2 1	VAROMOBIL SEPARATI.SET F-RA T3	1

Contents of partition set:

- Partition, rear adapter

Anti-Slip Mat for Shelf Tray 34 **VAROMOBIL**

Art. No. 9012 24:

- For shelf tray and shelf with rim from module 34 – 50

Art. No. 9012 34 11:

- For shelf tray with rim from module 34 – 50

Art. No. 9012 25:

- For shelf tray and shelf with rim from module 44
- Use Art. No. 9012 3413 for shelf trays with rim for module 34 – 50

Art. No. 9012 26:

- For shelf tray and shelf with rim from module 64



Article No.	Article Description	QTY
9012 24	VAROMOBIL ANTI-SLIP MAT 34	1
9012 25	VAROMOBIL ANTI-SLIP MAT 44	1
9012 26	VAROMOBIL ANTI-SLIP MAT 64-0	1
9012 34 11	VAROMOBIL ARM FBR MODUL 34	1
9012 34 13	VAROMOBIL ARM FBR MODUL 44	1

Shelf **VAROMOBIL**

- For clear storage of VAROBOXXes
- Alternatively, shelf flap can be attached to the front
- For mounting it is required to have the mounting screw kit (Art. No.: 9012 37)

Technical Data

Art. No.	For module versions:	Interior dimensions (D x W)
9012 34 3	34	232 x 702 mm
9012 44 3	44	336 x 944 mm
9012 64 3	64	336 x 1.428 mm

Article No.	Article Description	QTY
9012 34 3	VAROMOBIL SHELF 34-6	1
9012 44 3	VAROMOBIL SHELF 44-6	1
9012 64 3	VAROMOBIL SHELF 64-6	1
9012 37	VAROMOBIL SCREW KIT	1



Shelf Flap **VAROMOBIL**

- For safe storage of tools, equipment or spare parts
- Shelf flap can be attached at ground level or to the front of the shelf
- in two heights available
- For mounting it is required to have the mounting screw kit (Art. No. 9012 38)

Technical Data

Art. No.	For module versions:	Shelf flap heights:
9012 34 4 1	34	68 mm
9012 34 8 2	34	136 mm
9012 44 4 2	44	68 mm
9012 44 8 2	44	136 mm
9012 64 4 2	64	68 mm
9012 64 8 2	64	136 mm

Article No.	Article Description	QTY
9012 34 4 1	VAROMOBIL SHELF FLAP 34-4	1
9012 34 8 2	VAROMOBIL SHELF FLAP 34-8	1
9012 44 4 2	VAROMOBIL SHELF FLAP 44-4	1
9012 44 8 2	VAROMOBIL SHELF FLAP 44-8	1
9012 64 4 2	VAROMOBIL SHELF FLAP 64-4	1
9012 64 8 2	VAROMOBIL SHELF FLAP 64-8	1
9012 38	VAROMOBIL SCREW KIT SHELF FLAP	1



VAROsBOXX Set 3S

- 3x narrow drawer boxes with viewing window
- Quick and easy to integrate in the shelving unit
- Dimensions depending on VAROsBOXX (D x W x H): 351 x 147 x 153 mm
- Partition walls not included in delivery

Article No.	Article Description	QTY
9012 18	VAROSBOXX SET 3S INCL.RAIL	1

Content:

- 3x VAROsBOXX with 2x pull-out rails



VAROsBOXX Set S+B

- 1x wide and 1x narrow drawer box with viewing window
- Quick and easy to integrate in the shelving unit
- Dimensions VAROsBOXX S (D x W x H): 351 x 147 x 153 mm
- Dimensions VAROsBOXX B (D x W x H): 351 x 299 x 153 mm
- Partition walls not included in delivery

Article No.	Article Description	QTY
9012 19	VAROSBOXX SET S+B INCL.RAIL	1

Content:

- 2x VAROsBOXX with 1x pull-out rail



VAROsBOXX Set 3SF

- 3x narrow and flat drawer boxes with viewing window
- Quick and easy to integrate in the shelving unit
- Dimensions (D x W x H): 351 x 145 x 78 mm
- Partition walls not included in delivery

Article No.	Article Description	QTY
9012 20	VAROSBOXX SET F+S INCL.RAIL	1

Content:

- 3x VAROsBOXX with 2x pull-out rail



Pull-Out Rail T4 VAROMOBIL

- Snaps into place on the shelf variable division of the shelf for equipping the VAROBOXXes and VAROsBOXXes
- avoids slipping of the VAROBOXXes and VAROsBOXXes

Article No.	Article Description	QTY
9012 14	VAROMOBIL PULL-OUT RAIL	1



VAROsBOXX Narrow with Viewing Window

- Drawer box with viewing window
- Quick and easy to integrate in the shelving unit
- Dimensions (D x W x H): 351 x 147 x 153 mm
- Delivery without partition walls

Article No.	Article Description	QTY
9012 15	VAROSBOXX SMALL VIEW.WINDOW	1



VAROsBOXX Wide with Viewing Window

- Drawer box with viewing window
- Quick and easy to integrate in the shelving unit
- Dimensions (D x W x H): 351 x 299 x 153 mm
- Delivery without partition walls

Article No.	Article Description	QTY
9012 16	VAROSBOXX WIDE VIEW.WINDOW	1



VAROsBOXX Narrow/Flat with Viewing Window

- Drawer box with viewing window
- Quick and easy to integrate in the shelving unit
- Dimensions (D x W x H): 351 x 145 x 78 mm
- Delivery without partition walls

Article No.	Article Description	QTY
9012 17	VAROSBOXX FLAT VIEW.WINDOW	1



Narrow Separating Wall **VAROsBOXX**

- Practical wall for dividing the VAROsBOXX into different compartments, narrow, Art. No. 9012 15

Article No.	Article Description	QTY
9012 21	VAROSBOXX SEP:WALL NARROW	1



Wide Separating Wall **VAROsBOXX**

- Practical wall for dividing the VAROsBOXX into different compartments, wide, Art. No. 9012 16

Article No.	Article Description	QTY
9012 22	VAROSBOXX SEP:WALL WIDE	1



Narrow/Flat Separating Wall **VAROsBOXX**

- Practical wall for dividing the VAROsBOXX into different compartments, narrow/flat, Art. No. 9012 17

Article No.	Article Description	QTY
9012 23	VAROSBOXX SEP:WALL NARROW/FLAT	1



Single Lashing Point **VAROMOVE**

VAROMOVE:

- For bolting to the vehicle floor or to VAROMOVE module
- Screw onto the side of VAROMOVE module using screw kit (Art. No. 9013 0 14)
- Attach the work table to the VAROMOVE module

VAROMOBIL vehicle rack:

- For mounting of the side wall of VAROMOBIL vehicle rack
- Fastening using screw kit accessory (Art. No. 9012 01) and mounting rail (Art. No. 9012 12)

Article No.	Article Description	QTY
9012 35	VAROMOBIL VAROMOVE S.L.POINT	1
9012 01	VAROMOBIL SCREW KIT-ACCESSOR.	1
9012 12	VAROMOBIL VICE MOUNTING RAIL	1
9013 0 14	VAROMOVE SCREW SET	1



Lashing Rails for Gas Cylinders **VAROMOBIL**

- For mounting on the end of the vehicle
- For lashing gas cylinders
- Max. load: 200 daN
- Fastening using screw kit accessory (Art. No. 9012 01) and mounting rail (Art. No. 9012 12)

Article No.	Article Description	QTY
9012 39	VAROMOBIL LASH.RAIL F.GAS CYL.	1
9012 12	VAROMOBIL VICE MOUNTING RAIL	1
9012 01	VAROMOBIL SCREW KIT-ACCESSOR.	1



Lashing Strap for Gas Cylinders **VAROMOBIL**

- Ratchet strap with ProSafe hook for gas cylinder retention
- For loads up to 400 daN
- Length: approx. 0.93 m

Article No.	Article Description	QTY
9012 39 1	VAROMOBIL LASH.STRAPS F.G.CYL.	1



Lashing Strap w.Clamp.Lock a.Small Hook **VAROMOBIL**

- With clamping lock and ProSafe hook
- For loads up to 225 daN
- Strap width: 25 mm
- Length: in 3 m and 6 m

Article No.	Article Description	QTY
9012 45 1	VAROMOBIL LASHING STRAPS 3M	1
9012 45 2	VAROMOBIL LASHING STRAPS 6M	1



Lashing Strap with Ratchet 3.5 m **VAROMOBIL**

- Ratchet tightener and ProSafe hook
- For loads up to 400 daN
- Strap width: 25 mm
- Length: 3.5 m

Article No.	Article Description	QTY
9012 39 2	VAROMOBIL LASH.RATCH.STR.3.5M	1



Heavy Bench **VAROMOBIL**

- Folding bench with high console
- Distance from the floor to the mounting floor of the vehicle 490–670 mm
- For vehicles with low sill
- Tabletop dimensions (W × L × H): 280 × 1,000 × 36 mm
- Height folded up approx. 1200 mm
- Basic dimensions (W × L): approx. 300 × 300 mm

Note: Bench must be screwed through the vehicle floor



Article No.	Article Description	QTY
9012 54 1	VAROMOBIL WORKIN BENCH HEAVY	1

Heavy, Short Bench **VAROMOBIL**

- Folding bench with high console
- Distance from the floor to the mounting floor of the vehicle 640–820 mm
- For vehicles with high sill
- Tabletop dimensions (W × L × H): 280 × 1,000 × 36 mm
- Height folded up approx. 1015 mm
- Basic dimensions (W × L): approx. 300 × 300 mm

Note: Bench must be screwed through the vehicle floor



Article No.	Article Description	QTY
9012 54 2	VAROMOBIL BENCH HEAVY SHORT	1

Folding Bench **VAROMOBIL**

- Folding bench
- Height from the floor to the bench 515 mm
- Tabletop dimensions (W × L × H): 195 × 583 × 30 mm
- For load distribution, screw in up top and through the compartment floor
- Assembly kit (Art. No. 9012 57) required for assembly through wooden vehicle floor
- Space requirement behind module: approx. 200 mm

Given maximum load (100kg) in installation guide only for Sortimo Globelyst system. For VAROMOBIL systems significantly less due to missing tests.



Article No.	Article Description	QTY
9012 54 3	VAROMOBIL FOLDING BENCH	1
9012 57	VAROMOBIL SCREW KIT FLOOR	1

Screw Kit Floor **VAROMOBIL**

- For fastening accessories to the vehicle floor

Article No.	Article Description	QTY
9012 57	VAROMOBIL SCREW KIT FLOOR	1



Crash Plate **VAROMOBIL**

- For fastening in vehicle
- Can be optionally mounted on the side wall if it cannot be screwed in at the level of the compartment floor
- Mounting on the back of the side wall with screw kit Accessories (Art. No. 9012 01)
- Mounting for load distribution also possible

Article No.	Article Description	QTY
9012 46 1	VAROMOBIL CRASH PLATE	1
9012 01	VAROMOBIL SCREW KIT-ACCESSOR.	1

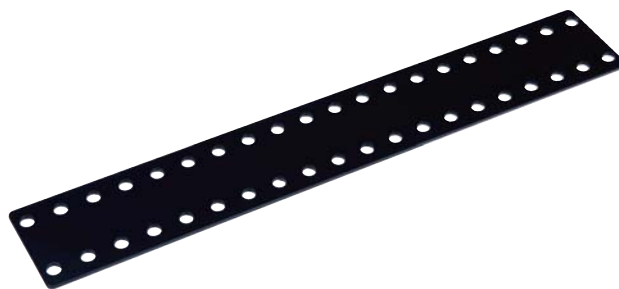

Crash Bracket **VAROMOBIL**

- For fastening in vehicle
- Can be optionally mounted on the side wall if it cannot be screwed in at the level of the compartment floor
- Mounting on the side wall with screw set accessory (Art. No. 9012 01)
- Mounting for load distribution also possible

Article No.	Article Description	QTY
9012 46 2	VAROMOBIL CRASH BRACKET	1
9012 01	VAROMOBIL SCREW KIT-ACCESSOR.	1

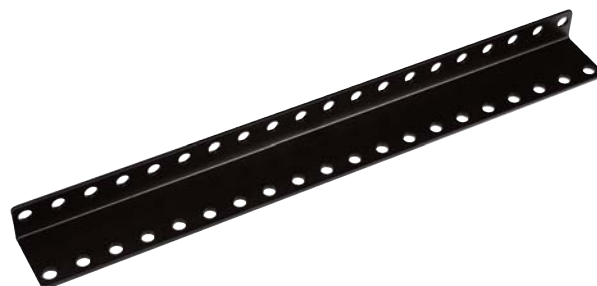

Parallel Vice Kit **VAROMOBIL**

- For mounting on VAROMOBIL side wall
- Bracket width: 100 mm
- Opening width: 125 mm
- Weight: 5.5 kg

Article No.	Article Description	QTY
9012 10	VAROMOBIL PARALLEL VICE KIT	1
9012 11	VAROMOBIL PARALLEL VICE	1
9012 12	VAROMOBIL VICE MOUNTING RAIL	1
9012 13	VAROMOBIL VICE BRACKET	1

Contents Art. No. 9012 10:

- 1× Parallel Vice
- 2× Mounting rails
- 1× Vice bracket
- 2× Screw kit



Loading Ramp 2,000 mm **VAROMOBIL**

- Aluminium loading rails with protective edge
- Driving surface with anti-slip coating P13
- Internal width of channels: 150 mm
- External width: 234 mm
- Protective rim height: 30/42 mm
- Load-bearing capacity: 380 daN

Article No.	Article Description	QTY
9012 2000	(PAIR) VAROMOBIL LOADING RAMP	1



VAROMOBIL Case Fixing

- Easy-to-use, variable clamp fastening for cases, boxes, and containers
- Screw set accessories (Art. No. 9012 01) used for mounting and depending on the type, the following compartment floor piping might also be necessary:

For basic module 34–50

- 2x Art. No. 9012 55 34

For basic module 44–60 and 44–80

- 2x Art. No. 9012 55 44

For basic module 64–80

- 2x Art. No. 9012 55 64

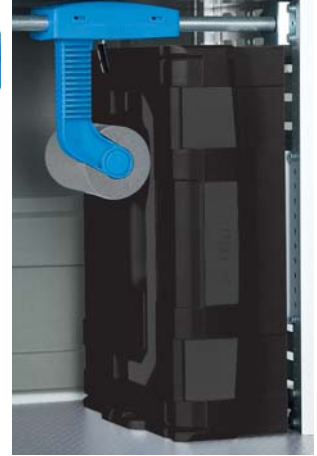

Article No.	Article Description	QTY
9012 55	VAROMOBIL CASE FIXING	1
9012 55 34	VAROMOBIL SHELF NO. MODULE 34	1
9012 55 64	VAROMOBIL SHELF NO. MODULE 64	1
9012 55 44	VAROMOBIL SHELF NO. MODULE 44	2
9012 01	VAROMOBIL SCREW KIT-ACCESSOR.	1

Screw Kit **VAROMOBIL**

- For attaching hose holders, compartments etc. to the side wall
- For securing VAROMOBIL accessories

Article No.	Article Description	QTY
9012 01	VAROMOBIL SCREW KIT-ACCESSOR.	1



Globelyst Hose Holder **VAROMOBIL**

- Suitable for all VAROMOBIL modules
- Made of plastic
- Includes a business card holder and an address field
- For secure storage of hoses and electric cables within easy reach
- The hole pattern can be mounted on the VAROMOBIL side wall by removing the hooks
- For mounting it has to be drilled into the side wall
- Secured using screw set VAROMOBIL, Art. No. 9012 01

Article No.	Article Description	QTY
9012 02	VAROMOBIL HOSE HOLDER	1
9012 01	VAROMOBIL SCREW KIT-ACCESSOR.	1



Plastic Storage Compartment **VAROMOBIL**

- Suitable for all VAROMOBIL modules
- For paper sizes: A4 – A12
- For securing to the system wall or the side of the vehicle rack
- Ideal for safely storing brochures, purchase order documents etc.
- Secured using screw set VAROMOBIL, Art. No. 9012 01

Article No.	Article Description	QTY
9012 03	VAROMOBIL STORAGE COMP.F.PAPER	1
9012 01	VAROMOBIL SCREW KIT-ACCESSOR.	1



Retaining Bracket **VAROMOBIL**

- Suitable for all VAROMOBIL modules
- Secures the VAROBOX roller safely in your vehicle
- Bracket is easy to secure to the vehicle separating wall or the aluminium panel on the vehicle rack
- Compatible assembly kit, Art. No. 9012 05

Article No.	Article Description	QTY
9012 04	VAROMOBIL RETAINING F.ROLLER	1
9012 05	VAROMOBIL ASS.KIT RE.BR.ROLLER	1



Storage Compartment **VAROMOBIL**

- Suitable for all VAROMOBIL modules
- Made of plastic
- With integrated toolbar
- Locks easily onto the side wall of the vehicle rack, includes integral tool holders
- Secured using screw set VAROMOBIL, Art. No. 9012 01

Article No.	Article Description	QTY
9012 06	VAROMOBIL STOR.COMP.SMALL PLS	1
9012 01	VAROMOBIL SCREW KIT-ACCESSOR.	1



Storage Compartment Large **VAROMOBIL**

- Suitable for all VAROMOBIL modules
- Depth 4 storage compartment
- Mounted on the side of the vehicle rack
- Provides large additional storage space
- Allows better utilisation of free space available in the vehicle
- Tool holder loops also attached
- Ideal for installation in area around sliding/rear door
- Secured using screw set VAROMOBIL, Art. No. 9012 01

Article No.	Article Description	QTY
9012 07	VAROMOBIL STOR.COMP.LARGE	1
9012 12	VAROMOBIL VICE MOUNTING RAIL	1
9012 01	VAROMOBIL SCREW KIT-ACCESSOR.	1



Hook Rack **VAROMOBIL**

- Specially designed for block side wall
- Possible to mount in alternative locations
- Suitable for hanging jackets, cables, hoses, etc
- Secured using screw set VAROMOBIL, Art. No. 9012 01

Article No.	Article Description	QTY
9012 08	VAROMOBIL HOOK RACK	1
9012 01	VAROMOBIL SCREW KIT-ACCESSOR.	1



Cable Hook **VAROMOBIL**

- For hanging extension cables up
- Can be mounted on either the long top tray or shelf tray

Article No.	Article Description	QTY
9012 51 1	VAROMOBIL CABLE HOOKS	1



Aluminium Wall Hook **VAROMOBIL**

Small wall hook:

- Dimensions (L x W): 80 x 120 mm

Medium wall hook:

- Dimensions (L x W): 115 mm x 140 mm

Large wall hook:

- With wide support surface
- Dimensions (L x W): 170 mm x 225 mm

The screw kit accessory (Art. No. 9012 01) is required for fixing.

Article No.	Article Description	QTY
9012 40 3	SMALL ALU WALL HOOK VAROMOBIL	1
9012 40 2	MEDIUM ALU WALL HOOK VAROMOBIL	1
9012 40 1	LARGE ALU WALL HOOK VAROMOBIL	1
9012 01	VAROMOBIL SCREW KIT-ACCESSOR.	1



Ceiling Hook **VAROMOBIL**

- For fixing all long-handled tools such as brooms, shovels, etc. under the vehicle roof

Article No.	Article Description	QTY
9012 52 1	VAROMOBIL CEILING HOOKS	1



Threaded Rod Holder **VAROMOBIL**

- For secure and neatly arranged transport of threaded rods etc.
- Secured using screw kit accessory (Art. No. 9012 01) and 2x mounting rails for load distribution (Art. No.9012 12)

Article No.	Article Description	QTY
9012 50 1	VAROMOBIL THREADED ROD HOLDER	1
9012 12	VAROMOBIL VICE MOUNTING RAIL	1
9012 01	VAROMOBIL SCREW KIT-ACCESSOR.	1

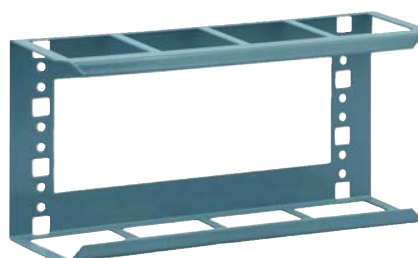

Rear Door Fixing Rail Shovel Holder **VAROMOBIL**

- For hanging up brooms, shovels etc.
- Optimum supplement to the rear door shovel holder
- Dimensions (L×W×H): 530×115×32 mm

Article No.	Article Description	QTY
9012 49 2	VAROMOBIL FIX.RAIL SHOVL.HOLDER	1



Rear Door Shovel Holder **VAROMOBIL**

- Optimum use of the space on the rear door
- Secure and safe transport of bulky items such as shovels, ladders etc.
- Ideal accessory: Shovel holder fixing aid (Art. No. 9012 49 2)
- Including installation instructions and fixing materials
- Max. load: 15 kg
- Dimensions (L x W x H): 1,700 x 530 x 180 mm

Article No.	Article Description	QTY
9012 49 1	VAROMOBIL REAR DOOR SHO.V.HOLD.	1
9012 49 2	VAROMOBIL FIX.RAIL SHO.V.HOLDER	1



Canister Holder **VAROMOBIL**

- With integrated securing strap
- For 10 litre plastic canisters or 20 litre sheet steel canisters
- Fixing with screw set VAROMOBIL (Art. No. 9012 01) and fixing rail (Art. No. 9012 12)

Article No.	Article Description	QTY
9012 48 10	VAROMOBIL CANISTER HOLDER 10L	1
9012 48 20	VAROMOBIL CANISTER HOLDER 20L	1
9012 12	VAROMOBIL VICE MOUNTING RAIL	1
9012 01	VAROMOBIL SCREW KIT-ACCESSOR.	1



Towel Roller **VAROMOBIL**

- For screwing to the side wall
- Screw kit accessory (Art. No. 9012 01)
- Dimensions (L x W): 285 x 130 mm

Article No.	Article Description	QTY
9012 47 2	VAROMOBIL TOWEL ROLLER	1
9012 01	VAROMOBIL SCREW KIT-ACCESSOR.	1



Roll Holder, Large **VAROMOBIL**

- Self-clamping function, prevents unrolling when driving
- For screwing to the side-wall using the screw kit accessory (Art. No. 9012 01) screw-on
- Suitable for all rolls up to 240 mm wide and 280 mm in diameter

Article No.	Article Description	QTY
9012 47 1	VAROMOBIL ROLL HOLDER LARGE	1
9012 01	VAROMOBIL SCREW KIT-ACCESSOR.	1



Water Drain Kit **VAROMOBIL**

- Kit consisting of wide-opening canister, holder, and drain cock
- Available for 5 or 10 litre capacity
- Secured using screw kit accessory (Art. No. 9012 01) and Mounting rails for load distribution (Art. No. 9012 12)
- Drilled holes are required for mounting

Art. No. 9012 41 1, volume 5 l:

- Dimensions (W x D x H): 295 x 165 x 295 mm

Art. No. 9012 41 2, volume 10 l:

- Dimensions (W x D x H): 290 x 160 x 400 mm

Article No.	Article Description	QTY
9012 41 1	VAROMOBIL WATER DRAIN KIT 5L	1
9012 41 2	VAROMOBIL WATER DRAIN KIT 10L	1
9012 12	VAROMOBIL VICE MOUNTING RAIL	1
9012 01	VAROMOBIL SCREW KIT-ACCESSOR.	1



Narrow Roof Ventilator **VAROMOBIL**

- Large roof ventilator
- For transporting gas cylinders
- Installation in vehicle ceiling
- We recommend installation by an expert workshop

Article No.	Article Description	QTY
9012 56 1	VAROMOBIL NARROW ROOF VENT.	1



Rotatable Roof Ventilator **VAROMOBIL**

- For transporting gas cylinders
- Installation in vehicle ceiling
- Can be rotated, and thus can be used for ventilation and extraction (heavy gases and light gases)
- We recommend installation by an expert workshop

Article No.	Article Description	QTY
9012 56 2	VAROMOBIL ROOF VENTILATOR	1



Round Floor Ventilator **VAROMOBIL**

- For transporting gas cylinders
- Installed in the vehicle floor
- Ø 100 mm
- We recommend installation by an expert workshop

Article No.	Article Description	QTY
9012 42 1	VAROMOBIL ROUND FLOOR VENTIL.	1



Ceiling Light LED (12 V) **VAROMOBIL**

- LED mounted light
- 24x LEDs
- 12 volt
- Dimensions (W x D x H): 168 x 88 x 9.1 mm

Article No.	Article Description	QTY
9012 43 1	VAROMOBIL CEILING LIGHT LED	1



Autoassistant **VAROMOBIL**

- Practical desk pad
- Flexible clamp for notes, with two storage compartments for folders and brochures as well as a cut-out for drink bottles
- The desk pad offers additional storage space
- Can be quickly secured to the front passenger seat by the backrest mounting fixture and seat belt guide on the side
- Not suitable for the installation on seats with non-removable head restraints (applies to the middle seat in the Renault Trafic, Opel Vivaro, Nissan Primastar, Renault Master, Opel Movano and NV400)

Technical Data

Dimensions (L x W x H): 480 x 661 x 362 mm
Weight: 6.9 kg

Article No.	Article Description	QTY
9012 32	VAROMOBIL AUTOASSISTANT	1



Configuration Examples



Small transporter

such as a VW Caddy, Mercedes Citan and many more.

Available in different lengths with or without drawers. Configuration example shows equipment installed in Mercedes Citan.

Medium-sized transporter

such as a VW T5, Mercedes Vito and many more.

Available in different lengths with or without drawers. Configuration example shows equipment installed in VW T5.



Large transporter

such as a Mercedes Sprinter, VW Crafter and many more.

Available in different length with or without drawers. Configuration example shows equipment installed in Citroen Jumper.



VAROMOVE – Your workplace where it is needed

The **VARi**able housekeeping system for your mobile ('MOVE') workplace.

This is a combination of transport system, workshop cart and mobile bench for flexible use in different locations. The stacking and internally interlocking function modules are fully compatible with our **VAROBOXXes** and we offer these as assortments with sector-specific and product-specific consumables and tools.



Your advantages

Economical

- Lightweight with aluminium-plastic mix
- Long service life
- Robust handling
- Ergonomic working heights, compatibility

Compatibility

- Can be expanded at any time
- Extensive range of accessories
- Compatible with FÖRCH VAROBOXX and VAROMOBIL-vehicle unit
- Can be integrated in all vehicles in an innovative manner

Innovative

- Combines transport, tidiness and work
- Combination of transport system, workshop vehicle and mobile bench
- Locking

VAROMOVE – Safe in your car

With **VAROMOVE** we have created the ideal transport solution for the boot of your car. Regardless of whether you are in field service or on the road as a service technician, your materials are stowed neatly and safely in these modules. The best thing about it is that **VAROMOVE** can quickly be integrated in your car, then removed from it again equally quickly. This means that nothing stops you from using your car for private purposes. The **VAROMOVE** modules can be secured using the integrated lashing eyes and a load strap in the vehicle.

It is also compatible with our **VAROMOBIL** vehicle system and can be secured with screws to the composite side wall.

Vehicle model:	Year of construction from	Modul 2	Modul 3	Modul 4
Audi A4 Avant B8	2008	✓	✗	✗
Audi A6 Avant C7	2011	✓	✗	✗
BMW 3... Touring F31	2012	✓	✗	✗
BMW 5... Touring F11	2010	✓	✗	✓
Mercedes-Benz C-Klasse T-Model S205	2014	✓	✗	✗
Mercedes-Benz E-Klasse T-Model S212	2009	✓	✗	✓
Skoda Oktavia III (5E)	2012	✓	✗	✗
Skoda Superb II (3T)	2008–2013	✓	✗	✗
VW Golf VII	2013	✓	✗	✗
VW Passat B7	2010–2014	✓	✗	•
VW Passat B8	2014	✓	✗	✗
VW Touran GP2*	2010	✓	✓	•

- ✓ Possible without restriction
- Possible in some cases
- ✗ Not possible

**The Touran also provides space for a stacked combination of VARO- MOVE modules with a width of 4 and 3 and a height of 506 mm



Module 2 B2 **VAROMOVE**

- Type WorkMo: 24-500 WO 24-500 2BB
- Incl. 2x box base
- Suitable for VAROBOXX 1 und 2
- Max. load on the top cover: 100 kg

Technical Data

Outer dimensions (DxWxH): 396 × 526 × 506 mm

Weight: 9.8 kg

Article No.	Article Description	QTY
9010 2 1	VAROMOVE MODULE 2 B2	1



Module 2 B3 **VAROMOVE**

- Type WorkMo: WO 24-500 3BB
- Incl. 3x box bases
- Suitable for VAROBOXX 1
- Max. load on the top cover: 100 kg

Technical Data

Outer dimensions (DxWxH): 396 × 526 × 506 mm

Weight: 11.4 kg

Article No.	Article Description	QTY
9010 2 2	VAROMOVE MODULE2 B3	1



Module 2 Universal Cupboard Door **VAROMOVE**

- Type WorkMo: WO 24-500 UST
- Incl. universal cupboard door with lock and 2x shelves
- Max. load on the top cover: 100 kg

Technical Data

Outer dimensions (DxWxH): 396 × 526 × 506 mm
Weight: 11.23 kg

Article No.	Article Description	QTY
9010 2 5	VAROMOVE MODULE2 UCD	1



Module 2 Drawers+MS **VAROMOVE**

- Type WorkMo: WO 24-500 SBL+MS
- Incl. 2x drawers: height 6
- Incl. multi-slide full extension suitable for VAROBOXX 1+2
- Max. load on the top cover: 100 kg

Technical Data

Outer dimensions (DxWxH): 396 × 526 × 506 mm
Weight: 14.7 kg
Drawer inner dimensions: 315 × 420 × 90 mm

Article No.	Article Description	QTY
9010 2 3	VAROMOVE MODULE2 DRAWER+MS	1



Module 2 Drawers 4H6 **VAROMOVE**

- Type WorkMo: WO 24-500 SBL6
- Incl. 4x drawers: Height 6
- Max. load on the top cover: 100 kg

Technical Data

Outer dimensions (DxWxH): 396 × 526 × 506 mm
Drawer inner dimensions: 315 × 420 × 90 mm
Weight: 18.6 kg

Article No.	Article Description	QTY
9010 2 4	VAROMOVE MODULE2 DRAWERS 4H6	1



Module 3 Drawers+Shelf Flap **VAROMOVE**

- Type WorkMo: WO 34-500 SBL+FBK
- Incl. 2x drawers: Height 6
- Individually adjustable by the partition set (Art. No. 9012 29)
- Suitable anti-slip mat (Art. No. 9012 27)
- Incl. 1x shelf flap: Height 8
- Max. load on the cover top: 100 kg

Technical Data

Outer dimensions (DxWxH):	396 × 789 × 506 mm
Drawers inner dimensions:	315 × 660 × 90 mm
Weight:	20.2 kg

Article No.	Article Description	QTY
9010 3 2	VAROMOVE MODULE3 DRAW.+SF	1



Module 3 Drawers 3H8 **VAROMOVE**

- Type WorkMo: WO 34-500 SBL 8
- Incl. 3x drawers: Height 8
- Individually adjustable by the partition set (Art. No. 9012 34 8 1)
- Suitable anti-slip mat (Art. No. 9012 27)
- Max. load on the cover top: 100 kg

Technical Data

Outer dimensions (DxWxH):	396 × 789 × 506 mm
Drawers inner dimensions:	315 × 660 × 124 mm
Weight:	22 kg

Article No.	Article Description	QTY
9010 3 3	VAROMOVE MODULE3 DRAWERS S3H8	1



Module 3 Drawers 4H6 **VAROMOVE**

- Type WorkMo: WO 34-500 SBL 6
- Incl. 4x Drawers: Height 6
- Individually adjustable by the partition set (Art. No. 9012 29)
- Suitable anti-slip mat (Art. No. 9012 27)
- Max. load on the top cover: 100 kg

Technical Data

Outer dimensions (DxWxH):	396 × 789 × 506 mm
Drawers inner dimensions:	315 × 660 × 90 mm
Weight:	24.1 kg

Article No.	Article Description	QTY
9010 3 4	VAROMOVE MODULE3 DRAWERS S4H6	1



Module4 Drawers+Drawers Slides **VAROMOVE**

- Type WorkMo: WO 44-500 SBL+AZS
- Incl. 2x drawers: Height 6
- Individually adjustable by the partition set (Art. No. 9012 30)
- Suistable anti-slip mat (Art. No. 9012 28)
- Incl. 1x shelf with drawer slides for VAROBOXXES
- Max. load on the cover top: 100 kg

Technical Data

Outer dimensions (DxWxH):	396 × 1.052 × 506 mm
Drawers inner dimensions:	315 × 890 × 90 mm
Weight:	24.9 kg

Article No.	Article Description	QTY
9010 4 2	VAROMOVE MODULE4 DRAW.+SLIDES	1



Module4 Drawers 3H8 **VAROMOVE**

- Type WorkMo: WO 44-500 SBL 8
- Incl. 3x drawers: Height 8
- Individually adjustable by the partition set (Art. No. 9012 44 8 1)
- Suitable anti-slip mat (Art. No. 9012 28)
- Max. load on the cover top: 100 kg

Technical Data

Outer dimensions (DxWxH)	396 × 1,052 × 506 mm
Drawer inner dimensions:	315 × 890 × 124 mm
Weight:	27 kg

Article No.	Article Description	QTY
9010 4 3	VAROMOVE MODULE4 DRAWERS 3H6	1



Module4 Drawers 4H6 **VAROMOVE**

- Type WorkMo: WO 44-500 SBL 6
- Incl. 4x drawers: Height 6
- Individually adjustable by the partition set (Art. No. 9012 30)
- Suitable anti-slip mat (Art. No. 9012 28)
- Max. load on the cover top: 100 kg

Technical Data

Outer dimensions (DxWxH): 396 × 1,052 × 506 mm
Drawer inner dimensions: 315 × 890 × 90 mm
Weight: 29.6 kg



Article No.	Article Description	QTY
9010 4 4	VAROMOVE MODULE4 DRAWERS 4H6	1

Roller B2 **VAROMOVE**

- Made from high-quality beech multiplex
- Flat roller surface
- Full rubber rollers, two with brakes
- Embedded ProSafe lashing points
- Suitable for module width 2
- Loadability: 150 kg

Technical Data

Dimensions (DxWxH): 493 × 612 × 144 mm

Article No.	Article Description	QTY
9013 2 1	VAROMOVE ROLLER B2 WIDTH 2	1



Roller B3 **VAROMOVE**

- Made from high-quality beech multiplex
- Flat roller surface
- Full rubber rollers, two with brakes
- Embedded ProSafe lashing points
- Suitable for module width 3
- Loadability: 150 kg

Technical Data

Dimensions (DxWxH): 493 × 854 × 144 mm

Article No.	Article Description	QTY
9013 3 1	VAROMOVE ROLLER B3 WIDTH 3	1



Roller B4 **VAROMOVE**

- Made from high-quality beech multiplex
- Flat roller surface
- Full rubber rollers, two with brakes
- Embedded ProSafe lashing points
- Suitable for module width 4
- Loadability: 150 kg

Technical Data

Dimensions (DxWxH): 1,096 × 493 × 144 mm

Article No.	Article Description	QTY
9013 4 1	VAROMOVE ROLLER B4 WIDTH 4	1



Wall Mount Roller **VAROMOVE**

- For safe and space-saving storage of the VAROMOVE transport roller
- Suitable for all VAROMOVE transport rollers

Technical Data

Dimensions (DxWxH): 254 × 270 × 97 mm
Weight: 1.5 kg

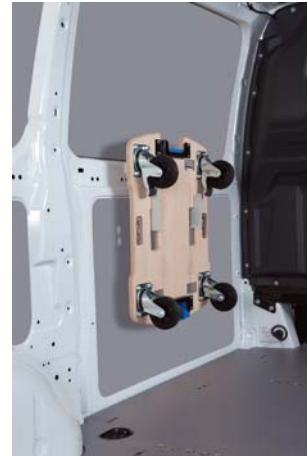

Article No.	Article Description	QTY
9013 0 1	VAROMOVE WALL MOUNT ROLLER	1

Worktop B2 **VAROMOVE**

- Can be connected to VAROMOVE module using latching mechanism
- Stable and flat work surface, ideal for the workshop, on the road or in the vehicle
- Suitable for VAROMOVE module width 2

Technical Data

Dimensions (DxWxH): 426 × 571 × 41 mm



Article No.	Article Description	QTY
9013 2 2	VAROMOVE WORKTOP CLOSED B2	1

Worktop B3 **VAROMOVE**

- Can be connected to VAROMOVE module using latching mechanism
- Stable and flat work surface, ideal for the workshop, on the road or in the vehicle
- Suitable for VAROMOVE module width 3

Technical Data

Dimensions (DxWxH): 426 × 834 × 41 mm



Article No.	Article Description	QTY
9013 3 2	VAROMOVE WORKTOP CLOSED B3	1

Wortop B4 **VAROMOVE**

- Can be connected to VAROMOVE module using latching mechanism
- Stable and flat work surface, ideal for the workshop, on the road or in the vehicle
- Suitable for VAROMOVE module width 4

Technical Data

Dimensions (DxWxH): 426 × 1,097 × 41 mm

Article No.	Article Description	QTY
9013 4 2	VAROMOVE WORKTOP CLOSED B4	1



Work Table B2 **VAROMOVE**

- Can be connected to VAROMOVE module using latching mechanism
- Stable and flat work surface, ideal for the workshop, on the road or in the vehicle
- Folding feet for better transport
- Suitable for VAROMOVE module width 2

Technical Data

Dimensions (DxWxH): 648 × 1,451 × 139 mm

Article No.	Article Description	QTY
9013 2 3	VAROMOVE WORK TABLE CLOSED B2	1



Work Table Transport Rail **VAROMOVE**

- Attachment to VAROMOVE module 2
- Screw kit (Art. No. 9013 0 14) has to be mounted to the side wall on the VAROMOVE module
- Easier transport of the work table

Article No.	Article Description	QTY
9013 2 4	VAROMOVE TRANSPORT RAIL	1



Single Lashing Point **VAROMOVE**

VAROMOVE:

- For bolting to the vehicle floor or to VAROMOVE module
- Screw onto the side of VAROMOVE module using screw kit (Art. No. 9013 0 14)
- Attach the work table to the VAROMOVE module

VAROMOBIL vehicle rack:

- For mounting of the side wall of VAROMOBIL vehicle rack
- Fastening using screw kit accessory (Art. No. 9012 01) and mounting rail (Art. No. 9012 12)



Article No.	Article Description	QTY
9012 35	VAROMOBIL VAROMOVE S.L.POINT	1

Aluminium Perforated Plate **VAROMOVE**

- Can be mounted on the side of the VAROMOVE module
- Attach accessories such as hooks or brackets to the punch outs
- Suitable for all VAROMOVE modules

Technical Data

Dimensions: 249 × 244 × 14 mm

Article No.	Article Description	QTY
9013 0 2	VAROMOVE ALU PERF.PLATE SW500	1



Bottle Holder **VAROMOVE**

- For attachment to the side aluminium perforated plate
- For 1.5 litre water bottles

Article No.	Article Description	QTY
9013 0 3	VAROMOVE BOTTLE HOLDER 1.5L	1



Spirit Level Holder **VAROMOVE**

- For attachment to the side aluminium perforated plate
- Bracket for spirit level or similar

Article No.	Article Description	QTY
9013 0 4	VAROMOVE SPIRIT LEVEL HOLDER	1



Aerosols Holder **VAROMOVE**

- For attachment to the side aluminium perforated plate
- Bracket for aerosols or similar

Article No.	Article Description	QTY
9013 0 5	VAROMOVE AEROSOLS HOLDER	1



Tool Holder **VAROMOVE**

- For attachment to the side aluminium perforated plate
- Bracket for tools such as pliers or similar

Article No.	Article Description	QTY
9013 0 6	VAROMOVE TOOL HOLDER	1



Tool Clamp Set 5-pce **VAROMOVE**

- For attachment to the side aluminium perforated plate
- For clamping tools or similar
- Clamp diameter: 19 / 25 / 28 / 32 / 38 mm

Article No.	Article Description	QTY
9013 0 7	VAROMOVE TOOL CLAMP SET 5-PCE	1



Tool Hook Set 9-pce **VAROMOVE**

- For attachment to the side aluminium perforated plate
- For clamping tools or similar

Consisting of:

- Tool single hook 40 / 66 / 90
- Tool double hook 40 / 66 / 90
- Tool base hook 40
- Tool base holder 80
- Tool gripper holder 61

Article No.	Article Description	QTY
9013 0 8	VAROMOVE TOOL HOOK SET 9-PCE	1



Partition Set Drawer B2H6 **VAROMOVE**

- For drawers with height 6 and module width 2
- Different grid systems for dividing the drawers

Article No.	Article Description	QTY
9013 2 5	VAROMOVE PART.SET DRAW.B2H6	1

Contents:

- 1x partition plate
- 2x slot dividers
- 5x drawer partition plate holders
- 2x adapters for slot dividers



Removal Guard **VAROMOVE**

- Stable lock for VAROBOXxes and drawers
- Screw onto the side with the screw kit (Art. No. 9013 0 14) of the VAROMOVE module
- Padlock is required
- Optimal theft protection in conjunction with steel cable (Art. No. 9013 0 13)

Article No.	Article Description	QTY
9013 0 12	VAROMOVE REMOVAL GUARD	1



Anti-theft Cable **VAROMOVE**

- For attachment to the VAROMOVE module
- Plastic-coated
- Difficult to cut through with wire cutter or saw

Technical Data

Cable length 500 mm

Article No.	Article Description	QTY
9013 0 13	VAROMOVE STEEL-CABLE 1500MM	1



Support Table **VAROMOVE**

- Screw kit (Art. No. 9013 0 14) has to be mounted to the side wall or of the VAROMOBIL vehicle equipment
- Convenient storage for documents, cans, consumables and tools
- Incl. anti slip mat

Technical Data

Dimensions (DxWxH): 229 x 353 x 151.5 mm

Article No.	Article Description	QTY
9013 0 9	VAROMOVE SUPPORT TABLE METAL	1



Power Distributor 230V **VAROMOVE**

- For attachment to the side wall with screw kit (Art. No. 9013 0 14) of the VAROMOVE module or the VAROMOBIL vehicle equipment
- Output: 4x plug socket
- Cable length: approx. 2m
- Incl. mounting plate and cable hook
- Power supply directly on-site
- Sturdy and weatherproof
- With hinged cover
- Time-saving and efficient work
- Approved according to BGV A3



Technical Data

Dimensions (WxDxH): 308 x 118 x 60 mm

Article No.	Article Description	QTY
9013 0 11	VAROMOVE 4XPOWER DISTRIBUTOR	1

Screw Set Accessory **VAROMOVE**

- For attaching accessories to the side wall
- Screw set = 4 screws



Article No.	Article Description	QTY
9013 0 14	VAROMOVE SCREW SET	1

Wall Mount **VAROMOVE**

- Stationary mounting
- For attaching the VAROMOVE module to the wall

Article No.	Article Description	QTY
9013 0 10	VAROMOVE WALL MOUNT	1



Floor Rail **VAROMOVE**

- Attachment to the floor, against/at right angles to the direction of travel
- For positioning and locking the VAROMOVE module
- Additional lashing strap is required

Article No.	Article Description	QTY
9013 0 15	VAROMOVE FLOOR RAIL	1



Roof Rack Set

- made from lightweight corrosion-resistant aluminium
- Aerodynamic shape to save fuel
- load-bearing capacity of max. 50 kg per bar
- quick and easy to mount (pre-mounted feet)
- includes mounting materials for respective vehicle type
- bolts directly onto vehicle roof
- TÜV and crash-tested
- Delivery does not include side supports in picture

The corresponding roof rack set for the respective vehicle type can be found in the table on page 18/981.



Article No.	Article Description	QTY
9014 1	ROOF RACK SET SMALL T2	1
9014 2	ROOF RACK SET MEDIUM T3	1
9014 3	ROOF RACK SET MEDIUM T4	1
9014 4	ROOF RACK SET BIG T3	1

Technical Data
Traverse width (mm)
1,170
1,400
1,400
1,600

Loading Roller for Roof Rack Set

- facilitates loading and unloading of vehicle roof
- Provides protection when loading vehicle and roof edge
- mountable on the roof rack bars
- Roller made from stainless steel
- adjustable bracket on loading roller

The corresponding loading roller for the respective vehicle type can be found in the table on page 18/981.

Article No.	Article Description	QTY
9014 200 750	LOAD.ROLL..200 X 750MM (LXW)	1
9014 425 750	LOAD.ROLL..425 X 750MM (LXW)	1
9014 200 910	LOAD.ROLL..200 X 910MM (LXW)	1
9014 310 910	LOAD.ROLL..310 X 910MM (LXW)	1
9014 425 1050	LOAD.ROLL..425 X 1050MM (LXW)	1
9014 200 1050	LOAD.ROLL..200 X 1050MM (LXW)	1
9014 310 1150	LOAD.ROLL..310 X 1150MM (LXW)	1
9014 425 1150	LOAD.ROLL..425 X 1150MM (LXW)	1



Lock for Roof Rack Set

- Protects against theft
- for retrofitting on rack feet

Article No.	Article Description	QTY
9014 10	(PAIR)LOCK FOR ROOF RACK SET	1



Side Supports for Roof Rack Set

- side stop for transport of goods on vehicle roof
- can be variably positioned on bars
- no tools needed for mounting or adjustment
- Delivered as a pair

Article No.	Article Description	QTY
9014 20	(PAIR)SIDE SUPP.F.ROOF RACK	1



The suitable roof racks for the respective car types can be taken from the below mentioned list

Model	from modelyear	Wheel base	Excess length	Height	Roof rack Art. No.	Amount of traverses	Loading roll Art. No.
Citroen Berlingo	2008	2,728 mm	-	normal	9014 1	2	9014 200 910
	2008	2,728 mm	L2	normal	9014 1	2	9014 200 910
Citroen Jumpy	2016	2,925 mm	-	normal	9014 2	3	9014 310 910
	2016	3,275 mm	-	normal	9014 2	3	9014 310 910
Citroen Jumper	2006	3,000 mm	-	normal	9014 4	3	9014 310 1150
	2006	3,000 mm	-	medium	9014 4	3	9014 310 1150
	2006	3,450 mm	-	normal	9014 4	3	9014 310 1150
	2006	3,450 mm	-	medium	9014 4	3	9014 310 1150
	2006	4,035 mm	-	medium	9014 4	3	9014 310 1150
	2006	4,035 mm	-	high	9014 4	3	9014 310 1150
	2006	4,035 mm	L4	medium	9014 4	3	9014 310 1150
Fiat Talento (tailgate)	2016	3,098 mm	-	normal	9014 4	3	9014 200 1050
	2016	3,498 mm	-	normal	9014 4	3	9014 200 1050
Fiat Talento (rear door)	2016	3,098 mm	-	normal	9014 4	3	9014 310 1150
	2016	3,498 mm	-	normal	9014 4	3	9014 310 1150
Fiat Ducato	2006	3,000 mm	-	normal	9014 4	3	9014 310 1150
	2006	3,000 mm	-	medium	9014 4	3	9014 310 1150
	2006	3,450 mm	-	normal	9014 4	3	9014 310 1150
	2006	3,450 mm	-	medium	9014 4	3	9014 310 1150
	2006	4,035 mm	-	medium	9014 4	3	9014 310 1150
	2006	4,035 mm	-	high	9014 4	3	9014 310 1150
	2006	4,035 mm	L4	medium	9014 4	3	9014 310 1150
	2006	4,035 mm	L4	high	9014 4	3	9014 310 1150
Ford Transit Connect	2003	2,664 mm	-	normal	9014 1	2	9014 200 910
	2014	3,062 mm	-	normal	9014 1	2	9014 200 910
	2014	2,662 mm	-	normal	9014 1	2	9014 200 910

(Continued on next page)

The suitable roof racks for the respective car types can be taken from the below mentioned list

Model	from modelyear	Wheel base	Excess length	Height	Roof rack Art. No.	Amount of traverses	Loading roll Art. No.
Ford Transit Custom	2013	2,933 mm	-	normal	9014 2	3	9014 425 750
	2013	3,300 mm	-	normal	9014 2	3	9014 425 750
Ford Transit	2014	3,300 mm	-	medium	9014 4	3	9014 200 910
	2014	3,300 mm	-	high	9014 4	3	9014 200 910
	2014	3,750 mm	-	medium	9014 4	3	9014 200 910
	2014	3,750 mm	-	high	9014 4	3	9014 200 910
	2014	3,750 mm	L4	high	9014 4	3	9014 200 910
Mercedes-Benz Citan	2012	2,697 mm	-	normal	9014 1	2	9014 200 910
	2012	3,081 mm	-	normal	9014 1	2	9014 200 910
Mercedes-Benz Vito (rear door L1 und L2)	2003	3,200 mm	-	normal	9014 3	4	9014 200 1050
Mercedes-Benz Vito (tailgate L3)	2003	3,430 mm	-	normal	9014 3	4	9014 200 1050
Mercedes-Benz Vito (rear door L3)	2003	3,430 mm	-	normal	9014 3	4	9014 425 1050
Mercedes-Benz Sprinter	2006	3,250 mm	-	normal	9014 4	3	9014 425 1150
	2006	3,250 mm	-	medium	9014 4	3	9014 200 910
	2006	3,665 mm	-	normal	9014 4	3	9014 425 1150
	2006	3,665 mm	-	medium	9014 4	3	9014 200 910
	2006	4,325 mm	-	medium	9014 4	3	9014 200 910
	2006	4,325 mm	L4	medium	9014 4	3	9014 200 910
Nissan NV300 (tailgate)	2016	3,098 mm	-	normal	9014 4	3	9014 200 1050
	2016	3,498 mm	-	normal	9014 4	3	9014 200 1050
Nissan NV300 (rear door)	2014	3,098 mm	-	normal	9014 4	3	9014 310 1150
	2014	3,498 mm	-	normal	9014 4	3	9014 310 1150
Opel Vivaro (tailgate)	2014	3,098 mm	-	normal	9014 4	3	9014 200 1050
	2014	3,498 mm	-	normal	9014 4	3	9014 200 1050
Opel Vivaro (rear door)	2014	3,098 mm	-	normal	9014 4	3	9014 310 1150
	2014	3,498 mm	-	normal	9014 4	3	9014 310 1150
Peugeot Partner	2008	2,728 mm	-	normal	9014 1	2	9014 200 910
	2008	2,728 mm	L2	normal	9014 1	2	9014 200 910
Peugeot Expert	2016	2,925 mm	-	normal	9014 2	3	9014 310 910
	2016	3,275 mm	-	normal	9014 2	3	9014 310 910
Peugeot Boxer	2006	3,000 mm	-	normal	9014 4	3	9014 310 1150
	2006	3,000 mm	-	medium	9014 4	3	9014 310 1150
	2006	3,450 mm	-	normal	9014 4	3	9014 310 1150
	2006	3,450 mm	-	medium	9014 4	3	9014 310 1150
	2006	4,035 mm	-	medium	9014 4	3	9014 310 1150
	2006	4,035 mm	-	high	9014 4	3	9014 310 1150
	2006	4,035 mm	L4	medium	9014 4	3	9014 310 1150
	2006	4,035 mm	L4	high	9014 4	3	9014 310 1150

(Continued on next page)

The suitable roof racks for the respective car types can be taken from the below mentioned list

Model	from modelyear	Wheel base	Excess length	Height	Roof rack Art. No.	Amount of traverses	Loading roll Art. No.
Renault Kangoo	2013	2,697 mm	-	normal	9014 1	2	9014 200 910
	2013	3,081 mm	-	normal	9014 1	2	9014 200 910
Renault Trafic (tailgate)	2014	3,098 mm	-	normal	9014 4	3	9014 200 1050
	2014	3,498 mm	-	normal	9014 4	3	9014 200 1050
Renault Trafic (rear door)	2014	3,098 mm	-	normal	9014 4	3	9014 310 1150
	2014	3,498 mm	-	normal	9014 4	3	9014 310 1150
Toyota ProAce	2016	2,925 mm	-	normal	9014 2	3	9014 310 910
	2016	3,275 mm	-	normal	9014 2	3	9014 310 910
VW Caddy	2010	2,682 mm	-	normal	9014 1	2	9014 200 750
	2010	3,002 / 3,006 mm	-	normal	9014 1	2	9014 200 750
VW T5/T6 (tailgate)	2002	3,000 mm	-	normal	9014 3	4	9014 200 1050
	2002	3,400 mm	-	normal	9014 3	4	9014 200 1050
VW T5/T6 (rear door)	2002	3,000 mm	-	normal	9014 3	4	9014 425 1050
	2002	3,400 mm	-	normal	9014 3	4	9014 425 1050
VW Crafter	2006 – 2015	3,250 mm	-	normal	9014 4	3	9014 425 1150
	2006 – 2015	3,250 mm	-	medium	9014 4	3	9014 200 910
	2006 – 2015	3,665 mm	-	normal	9014 4	3	9014 425 1150
	2006 – 2015	3,665 mm	-	medium	9014 4	3	9014 200 910
	2006 – 2015	4,325 mm	-	medium	9014 4	3	9014 200 910
	2006 – 2015	4,325 mm	L4	medium	9014 4	3	9014 200 910